

WORKSTATIONS COLLECTION

4MARIANI | TECH

Scrivanie Manageriali Managerial Desks	4 Conic 16 Titan
Scrivanie Operative Operative Desks	34 Line 54 Elevate 62 Flap 71 Square 80 Plus 88 Base
Complementi per scrivanie Fittings for desks	96
Sedute Direzionali Managerial Seatings	112 Logic 114 Of Course 117 Grade 118 Mission
Sedute Operative Task Seatings	122 Best 123 Wind
Divani per area attesa Sofas for waiting areas	126 Cubic 127 Wolf
Mobili contenitori Storage Cabinets	131 Oasis 137 Basic 144 Squad 150 Major 155 Open
Bancone Reception Reception Counter	160 Passage
Pareti attrezzate Equipped Partition	164 Equipe
Pareti divisorie Partition Walls	176 Hundred 180 Eighty 185 Fifty 189 Twenty

**SCRIVANIE MANAGERIALI
MANAGERIAL DESKS**

CONIC



La struttura portante delle scrivanie è costituita da una coppia di monorotaie sottopiano in acciaio verniciato, a cui sono fissate due gambe in tubolare metallico conico con piedini di appoggio a terra; queste strutture metalliche sono disponibili verniciate a polveri epossidiche in colore bianco opaco (RAL 9010), nero opaco (RAL 9005) o alluminio (RAL 9006). Sono disponibili solamente scrivanie rettangolari e per ognuna di esse è disponibile anche un allungo laterale. I piani delle scrivanie sono in melaminico spessore 25 mm in diverse finiture oppure in cristallo trasparente, in cristallo grigio verniciato nero oppure in cristallo extrachiaro verniciato bianco.

The supporting structure of the desks consists of a pair of powder coated steel monorails placed under the top, to which are fixed two legs in metal conic tube with its round feet; these metallic structures are available epoxy powder coated in matt white (RAL 9010), matt black (RAL 9005) or in aluminum color (RAL 9006). Only rectangular desks are available and the relative lateral extension. The tops of desks are in melamine coated panel thickness 25 mm. in different finishes or in clear glass, in grey glass painted black or in extraclear glass painted white. Modesty panels in melamine and steel are available and also front dividing screens in melamine.

The oval or square conference tables have the same structure and finishes of the top.

The pedestal unit on wheels with 3 drawers has a sheet metal structure painted with epoxy powders in matt white (RAL 9010), matt black (RAL 9005) or aluminum (RAL 9006) with melamine top and drawer fronts. It is equipped with a lock and chromed handles. The cabinet on wheels with three drawers and one door has a melamine structure and is equipped with locks and chromed handles.

Sono disponibili pannelli di cortesia in melaminico e in acciaio e schermi frontali divisorii in melaminico. I tavoli riunione ovali o quadrati hanno la stessa tipologia di struttura e di finitura del piano. La cassettiera su ruote a 3 cassetti ha una struttura in lamiera verniciata a polveri epossidiche in colore bianco opaco (RAL 9010), nero opaco (RAL 9005) o alluminio (RAL 9006) con top e frontali dei cassetti in melaminico. E' dotata di serratura e di maniglie cromate.

Il mobile su ruote con tre cassetti ed un'anta ha una struttura in melaminico ed è dotato di serrature e maniglie cromate.







CONIC - Finiture disponibili - Available finishes

Piani scrivanie ed elementi in melaminico - Desk tops and melamine elements



Lino FA41



Noce Chiaro LM01



Rovere Grigio LG18



Rovere Bianco LK84



Noce Canaletto LN83



Rovere Spessart LM76



Rovere Magister LK97



Ash S001



Bianco B007



Grigio U110



Nero U129



Avorio U100



Grafite UB08

Parti metalliche verniciate a polveri epossidiche - Metal parts epoxy powder coated



Bianco opaco RAL 9010
Matt white RAL 9010



Alluminio RAL 9006
Aluminum RAL 9006



Nero opaco RAL 9005
Matt black RAL 9005

Piani delle scrivanie in cristallo - Glass desk tops



Cristallo trasparente
Clear glass



Vetro extrachiaro verniciato bianco
Extraclear glass white varnished



Vetro fumè verniciato nero
Smoked glass black varnished



CONIC - Scrivanie e allunghi - Desks and extensions



Scrivanie in melaminico.
Desks in melamine.

Code	Dimension cm	Dimension inches	Price €
ZZCONICDSK3000	180x90x72h	70 ¹¹ / ₁₆ x 35 ¹ / ₂ x 28 ¹¹ / ₁₆ h	1127,00
ZZCONICDSK3003	200x100x72h	78 ¹¹ / ₁₆ x 39 ¹¹ / ₁₆ x 28 ¹¹ / ₁₆ h	1343,00

Piano in melaminico. Base verniciata bianco opaco (RAL 9010), nero opaco (RAL 9005) o alluminio (RAL 9006).
Top in melamine coated panel. Base epoxy powder coated in matt white (RAL 9010) or matt black (RAL 9005) or aluminum (RAL 9006).

Scrivanie in cristallo trasparente.
Desks in clear glass.



Code	Dimension cm	Dimension inches	Price €
ZZCONICDSK3001	180x90x71h	70 ¹¹ / ₁₆ x 35 ¹ / ₂ x 28 ¹¹ / ₁₆ h	1992,00
ZZCONICDSK3004	200x100x71h	78 ¹¹ / ₁₆ x 39 ¹¹ / ₁₆ x 28 ¹¹ / ₁₆ h	2369,00

Piano in cristallo trasparente. Base verniciata bianco opaco (RAL 9010), nero opaco (RAL 9005) o alluminio (RAL 9006).
Top in clear glass. Base epoxy powder coated in matt white (RAL 9010) or matt black (RAL 9005) or aluminum (RAL 9006).

Scrivanie in cristallo verniciato.
Single desks in varnished glass.



Code	Dimension cm	Dimension inches	Price €
ZZCONICDSK3002	180x90x71h	70 ¹¹ / ₁₆ x 35 ¹ / ₂ x 28 ¹¹ / ₁₆ h	2301,00
ZZCONICDSK3005	200x100x71h	78 ¹¹ / ₁₆ x 39 ¹¹ / ₁₆ x 28 ¹¹ / ₁₆ h	2763,00

Piano in cristallo extrachiaro verniciato bianco o fumè verniciato nero. Base verniciata bianco opaco (RAL 9010), nero opaco (RAL 9005) o alluminio (RAL 9006).
Top in extraclear white varnished glass or in smoked black varnished glass. Base epoxy powder coated in matt white (RAL 9010) or matt black (RAL 9005) or aluminum (RAL 9006).

Canalina in acciaio adatta per scrivania con top in melaminico.
Metal channel suitable for desk with melamine top.



Code	Dimension cm	Dimension inches	Price €
ZZCONICACCD309	160	63"	156,00
Per scrivania cm 180 - For desk 70 ¹¹ / ₁₆ "			
ZZCONICACCD310	180	70 ¹¹ / ₁₆ "	172,00
Per scrivania cm 200 - For desk 78 ¹¹ / ₁₆ "			

Verniciata bianco opaco (RAL 9010), nero opaco (RAL 9005) o alluminio (RAL 9006).
Epoxy powder coated in matt white (RAL 9010) or matt black (RAL 9005) or aluminum (RAL 9006).

Allungo in melaminico.
Extension in melamine.



Code	Dimension cm	Dimension inches	Price €
ZZCONICDSK3006	80x60x72h	31 ¹ / ₂ x 23 ¹¹ / ₁₆ x 28 ¹¹ / ₁₆ h	721,00

Piano in melaminico. Base verniciata bianco opaco (RAL 9010), nero opaco (RAL 9005) o alluminio (RAL 9006).
Top in melamine coated panel. Base epoxy powder coated in matt white (RAL 9010) or matt black (RAL 9005) or aluminum (RAL 9006).

CONIC - Scrivanie e allunghi - Desks and extensions



Allungo in cristallo trasparente.
Extension in clear glass.

Code	Dimension cm	Dimension inches	Price €
ZZCONICDSK3007	80x60x71h	31 ¹ / ₂ x 23 ¹¹ / ₁₆ x 28 ¹¹ / ₁₆ h	973,00

Piano in cristallo trasparente. Base verniciata bianco opaco (RAL 9010), nero opaco (RAL 9005) o alluminio (RAL 9006).
Top in clear glass. Base epoxy powder coated in matt white (RAL 9010) or matt black (RAL 9005) or aluminum (RAL 9006).



Allungo in cristallo verniciato.
Extension in varnished glass.

Code	Dimension cm	Dimension inches	Price €
ZZCONICDSK3008	80x60x71h	31 ¹ / ₂ x 23 ¹¹ / ₁₆ x 28 ¹¹ / ₁₆ h	1041,00

Piano in cristallo extrachiaro verniciato bianco o fumè verniciato nero. Base verniciata bianco opaco (RAL 9010), nero opaco (RAL 9005) o alluminio (RAL 9006).
Top in extraclear white varnished glass or in smoked black varnished glass. Base epoxy powder coated in matt white (RAL 9010) or matt black (RAL 9005) or aluminum (RAL 9006).

Pannello di cortesia in acciaio per scrivania con top in melaminico. Completo di 2 staffe per il fissaggio.
Metal modesty panel for melamine top desk. Complete with 2 fixing brackets.



Code	Dimension cm	Dimension inches	Price €
ZZCONICACCD300	160x30	63" x 11 ¹ / ₄ "	265,00
Per scrivania cm 180 - For desk 70 ¹¹ / ₁₆ "			
ZZCONICACCD301	180x30	70 ¹¹ / ₁₆ x 11 ¹ / ₄ "	289,00
Per scrivania cm 200 - For desk 78 ¹¹ / ₁₆ "			

In acciaio verniciato bianco opaco (RAL 9010), nero opaco (RAL 9005) o alluminio (RAL 9006).
In epoxy powder coated metal in matt white (RAL 9010) or matt black (RAL 9005) or aluminum (RAL 9006).

Pannello di cortesia in melaminico per scrivania con top in melaminico. Completo di 2 staffe per il fissaggio.
Melamine modesty panel for melamine top desk. Complete with 2 fixing brackets.



Code	Dimension cm	Dimension inches	Price €
ZZCONICACCD303	160x30x1,9	63" x 11 ¹ / ₄ " x 3/4"	254,00
Per scrivania cm 180 - For desk 70 ¹¹ / ₁₆ "			
ZZCONICACCD304	180x30x1,9	70 ¹¹ / ₁₆ x 11 ¹ / ₄ " x 3/4"	261,00
Per scrivania cm 200 - For desk 78 ¹¹ / ₁₆ "			

Pannello in melaminico. Staffe verniciate bianco opaco (RAL 9010), nero opaco (RAL 9005) o alluminio (RAL 9006).
Melamine coated panel. Brackets epoxy powder coated in matt white (RAL 9010) or matt black (RAL 9005) or aluminum (RAL 9006).

CONIC - Scrivanie e allunghi - Desks and extensions



Schermo frontale in melaminico per scrivania con top in melaminico. Completo di 2 staffe per il fissaggio.

Melamine front screen panel for melamine top desk. Complete with 2 fixing brackets.

Code	Dimension cm	Dimension inches	Price €
ZZCONICACCD307	180x55x1,9	70 ¹¹ / ₁₆ x 21 ¹¹ / ₁₆ x 3/4	291,00
Per scrivania cm 180 - For desk 70 ¹¹ / ₁₆			
ZZCONICACCD308	200x55x1,9	78 ¹¹ / ₁₆ x 21 ¹¹ / ₁₆ x 3/4	302,00
Per scrivania cm 200 - For desk 78 ¹¹ / ₁₆			

Pannello in melaminico. Staffe verniciate bianco opaco (RAL 9010), nero opaco (RAL 9005) o alluminio (RAL 9006). Melamine coated panel. Brackets epoxy powder coated in matt white (RAL 9010) or matt black (RAL 9005) or aluminum (RAL 9006).

CONIC - Tavoli riunione - Meeting tables



Tavolo riunione a forma di botte in melaminico.

Boat shaped meeting table in melamine.

Code	Dimension cm	Dimension inches	Price €
ZZCONICMTB3020	230x105x72h	90 ¹¹ / ₁₆ x 41 ¹¹ / ₁₆ x 28 ¹¹ / ₁₆ h	1232,00
ZZCONICMTB3023	280x120x72h	110 ¹¹ / ₁₆ x 39 ¹¹ / ₁₆ x 28 ¹¹ / ₁₆ h	1483,00

Piano in melaminico. Base verniciata bianco opaco (RAL 9010), nero opaco (RAL 9005) o alluminio (RAL 9006). Top in melamine coated panel. Base epoxy powder coated in matt white (RAL 9010) or matt black (RAL 9005) or aluminum (RAL 9006).

Tavolo riunione a forma di botte in cristallo trasparente.

Boat shaped meeting table in clear glass.



Code	Dimension cm	Dimension inches	Price €
ZZCONICMTB3021	230x105x71h	90 ¹¹ / ₁₆ x 41 ¹¹ / ₁₆ x 28 ¹¹ / ₁₆ h	2626,00
ZZCONICMTB3024	280x120x71h	110 ¹¹ / ₁₆ x 39 ¹¹ / ₁₆ x 28 ¹¹ / ₁₆ h	3345,00

Piano in cristallo trasparente. Base verniciata bianco opaco (RAL 9010), nero opaco (RAL 9005) o alluminio (RAL 9006). Top in clear glass. Base epoxy powder coated in matt white (RAL 9010) or matt black (RAL 9005) or aluminum (RAL 9006).

Tavolo riunione a forma di botte in cristallo verniciato.

Boat shaped meeting table in varnished glass.



Code	Dimension cm	Dimension inches	Price €
ZZCONICMTB3022	230x105x71h	90 ¹¹ / ₁₆ x 41 ¹¹ / ₁₆ x 28 ¹¹ / ₁₆ h	3133,00
ZZCONICMTB3025	280x120x71h	110 ¹¹ / ₁₆ x 39 ¹¹ / ₁₆ x 28 ¹¹ / ₁₆ h	4090,00

Piano in cristallo extrachiaro verniciato bianco o fumè verniciato nero. Base verniciata bianco opaco (RAL 9010), nero opaco (RAL 9005) o alluminio (RAL 9006). Top in extraclear white varnished glass or in smoked black varnished glass. Base epoxy powder coated in matt white (RAL 9010) or matt black (RAL 9005) or aluminum (RAL 9006).

Tavolo riunione quadrato in melaminico.

Square meeting table in melamine.



Code	Dimension cm	Dimension inches	Price €
ZZCONICMTB3026	160x160x72h	63" x 63" x 28 ¹¹ / ₁₆ h	932,00

Piano in melaminico. Base verniciata bianco opaco (RAL 9010), nero opaco (RAL 9005) o alluminio (RAL 9006). Top in melamine coated panel. Base epoxy powder coated in matt white (RAL 9010) or matt black (RAL 9005) or aluminum (RAL 9006).

CONIC - Tavoli riunione - Meeting tables



Tavolo riunione quadrato in cristallo trasparente.

Square meeting table in clear glass.

Code	Dimension cm	Dimension inches	Price €
ZZCONICMTB3027	160x160x71h	63" x 63" x 28 ¹¹ / ₁₆ h	2909,00

Piano in cristallo trasparente. Base verniciata bianco opaco (RAL 9010), nero opaco (RAL 9005) o alluminio (RAL 9006). Top in clear glass. Base epoxy powder coated in matt white (RAL 9010) or matt black (RAL 9005) or aluminum (RAL 9006).



Tavolo riunione quadrato in cristallo verniciato.

Square meeting table in varnished glass.

Code	Dimension cm	Dimension inches	Price €
ZZCONICMTB3028	160x160x71h	63" x 63" x 28 ¹¹ / ₁₆ h	3196,00

Piano in cristallo extrachiaro verniciato bianco o fumè verniciato nero. Base verniciata bianco opaco (RAL 9010), nero opaco (RAL 9005) o alluminio (RAL 9006). Top in extraclear white varnished glass or in smoked black varnished glass. Base epoxy powder coated in matt white (RAL 9010) or matt black (RAL 9005) or aluminum (RAL 9006).

CONIC - Cassettiera e mobile di servizio su ruote - Pedestal and side cabinet on casters



Cassettiera su ruote con 3 cassetti dotati di serratura e vaschetta portacancelleria.

Chest of drawers on casters with 3 drawers with lock and stationery tray.

Code	Dimension cm	Dimension inches	Price €
ZZCONICSPD3000	42x53x52h	16 ¹¹ / ₁₆ x 20 ¹¹ / ₁₆ x 20 ¹¹ / ₁₆ h	653,00

Struttura in metallo con top e frontali rivestiti con pannelli di melaminico. Retro e fianchi in metallo verniciato bianco opaco (RAL 9010), nero opaco (RAL 9005) o alluminio (RAL 9006). Metal structure with top and fronts covered with melamine panels. Back and side panels in epoxy powder coated in matt white (RAL 9010) or matt black (RAL 9005) or aluminum (RAL 9006).



Mobile di servizio su ruote in melaminico con 1 anta con serratura e 3 cassetti dotati di serratura e vaschetta portacancelleria.

Sideboard cabinet on casters in melamine with 1 door with lock and 3 drawers with lock and stationery tray.

Code	Dimension cm	Dimension inches	Price €
ZZCONICSPD3001	92x58x60h	36 ¹¹ / ₁₆ x 22 ¹¹ / ₁₆ x 23 ¹¹ / ₁₆ h	1438,00

In melaminico.
In melamine.

TITAN



La struttura portante delle scrivanie è costituita da quattro travi sottopiano in acciaio che alle loro estremità sono fissate ad un giunto che a sua volta è collegato alla gamba sempre in acciaio che appoggia a terra. Importante caratteristica di questo modello è che il giunto e le gambe possono essere scelte liberamente in 3 finiture diverse: verniciate a polveri epossidiche in colore bianco semilucido, in colore nero semilucido oppure cromate.

Le travi sottopiano invece nelle versioni con piani "coprenti" sono verniciate in colore grigio, mentre nelle versioni con piano trasparente sono disponibili verniciate a polveri epossidiche in colore bianco semilucido, in colore nero semilucido oppure cromate.

GIUNTO E GAMBA BIANCA
WHITE JOINT AND LEG



GIUNTO E GAMBA NERA
BLACK JOINT AND LEG



GIUNTO E GAMBA CROMATA
CHROMED JOINT AND LEG



GIUNTO CROMATO E GAMBA BIANCA
CHROMED JOINT AND WHITE LEG



GIUNTO CROMATO E GAMBA NERA
CHROMED JOINT AND BLACK LEG



Le scrivanie sono disponibili solo con forma rettangolare con 4 gambe oppure con 3 gambe ed un mobile allungo. I piani delle scrivanie sono in melaminico spessore 25 mm in diverse finiture, in cristallo extrachiaro oppure in cristallo verniciato bianco, nero oppure grigio. Sono disponibili pannelli di cortesia in melaminico.

I tavoli riunioni rettangolari, quadrati o rotondi hanno le stesse finiture delle scrivanie. Il mobile allungo e la cassetiera fissa hanno la struttura sempre in melaminico bianco o nero ma con top e fianchi disponibili anche in altre finiture di melaminico; le ante scorrevoli frontali sono disponibili in melaminico o in cristallo verniciato bianco, nero o grigio. I frontali dei cassetti con serratura sono disponibili in melaminico o in cristallo verniciato bianco, nero o grigio. Le maniglie sono disponibili verniciate bianche, nere o cromate.

The supporting structure of the desks consists of four steel beams fixed under the top which at their ends are fixed to a joint which itself is connected to the steel leg that rests on the ground. An important feature of this model is that the joint and the legs can be freely chosen in 3 different finishes: epoxy powder coated in semi-gloss white, in semi-gloss black or chromed. The beams under the top, on the other hand, in the versions with "blind" tops are painted in gray color, while in the versions with transparent top they are available painted with epoxy powders in semi-gloss white, in semi-gloss black or chromed. The desks are available only with rectangular shape with 4 legs or with 3 legs and a side extension. The desk tops are in 25 mm thick melamine in different finishes, in extra-clear glass or in white, black or gray painted glass. Melamine courtesy panels are available.

The rectangular, square or round meeting tables have the same finishes as the desks. The extension unit and the fixed pedestal have the structure always in white or black melamine, while the top and sides can be also in other melamine finishings; the front sliding doors are available in melamine or in white, black or gray painted glass. The fronts of the drawers with locks are available in melamine or in white, black or gray painted glass. The handles are available painted in white, black or chrome.



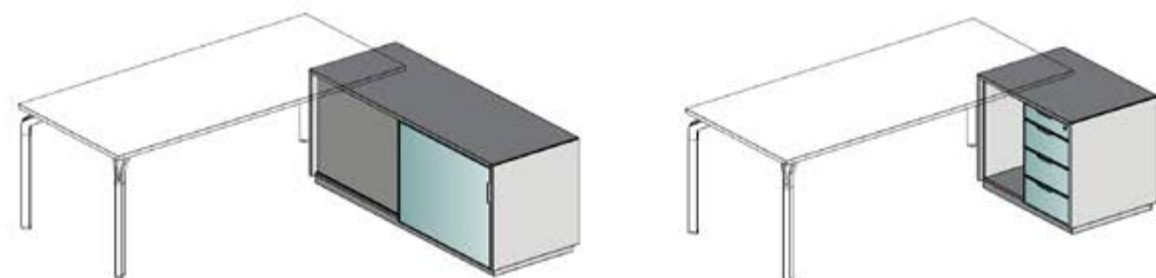
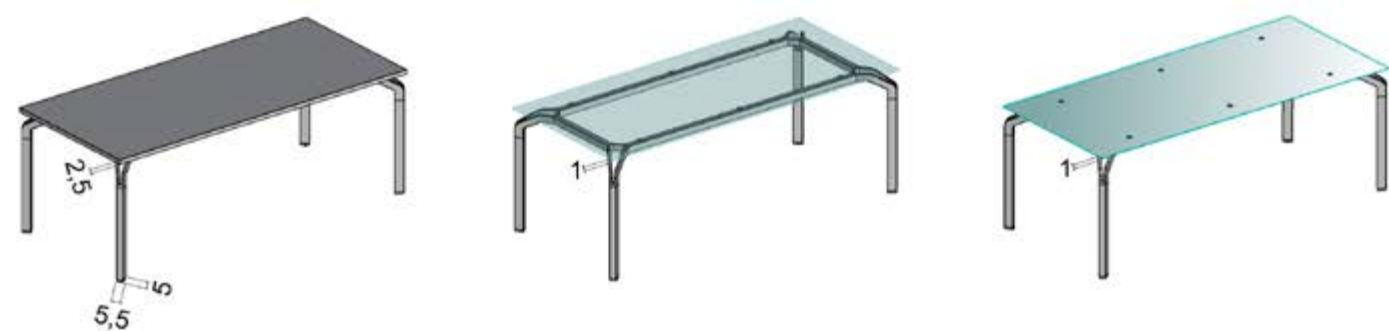

TITAN - Finiture disponibili - Available finishes

Piani scrivanie ed elementi in melaminico - Desk tops and melamine elements



Lino FA41



Noce Chiaro LM01



Rovere Grigio LG18



Rovere Bianco LK84



Noce Canaletto LN83



Rovere Spessart LM76



Rovere Magister LK97



Ash S001



Bianco B007



Grigio U110

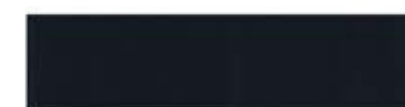

Nero U129



Avorio U100



Grafite U808

Parti metalliche verniciate a polveri epossidiche - Metal parts epoxy powder coated



Semilucido bianco (RAL 9003)
Semi-gloss white (RAL 9003)



Cromato
Chromed



Semilucido nero (RAL 9005)
Semi-gloss black (RAL 9005)

Piani delle scrivanie in cristallo - Glass top desks



Cristallo extrachiaro
Extra-Clear glass



Vetro extrachiaro verniciato bianco
RAL 9003
Extra-Clear Glass white painted RAL
9003



Vetro extrachiaro verniciato grigio RAL
7046
Extra-Clear Glass grey painted RAL
7046



Vetro verniciato nero RAL 9005
Glass black painted RAL 9005

TITAN - Scrivanie - Desks



Scrivanie con top in melaminico.
Desks with melamine top.

Code	Dimension cm	Dimension inches	Price €
ZZTITANDSK6000	180x90x74h	70 ¹¹ / ₁₆ x 35 ¹ / ₂ x 29 ¹ / ₈ h	2500,00
ZZTITANDSK6003	200x90x74h	78 ¹ / ₄ x 35 ¹ / ₂ x 29 ¹ / ₈ h	2555,00
ZZTITANDSK6006	220x100x74h	86 ¹ / ₈ x 39 ¹ / ₈ x 29 ¹ / ₈ h	2776,00

Piano in melaminico. Travi sottopiano verniciate grigio goffrato. Giunti e gambe verniciate bianco o nero semilucido.

Top in melamine coated panel. Beams under the top epoxy powder coated in textured grey. Joints and legs epoxy powder coated in semi-gloss white or black.

Scrivanie con top in cristallo extrachiaro.
Desks with extra-clear glass top.



Code	Dimension cm	Dimension inches	Price €
ZZTITANDSK6001	180x90x74h	70 ¹¹ / ₁₆ x 35 ¹ / ₂ x 29 ¹ / ₈ h	4111,00
ZZTITANDSK6004	200x90x74h	78 ¹ / ₄ x 35 ¹ / ₂ x 29 ¹ / ₈ h	4267,00
ZZTITANDSK6007	220x100x74h	86 ¹ / ₈ x 39 ¹ / ₈ x 29 ¹ / ₈ h	4996,00

Piano in cristallo extrachiaro. Travi sottopiano, giunti e gambe verniciate bianco o nero semilucido.

Top in extra-clear glass. Beams under the top, joints and legs epoxy powder coated in semi-gloss white or black.

Scrivanie con top in cristallo verniciato.
Desks with painted glass top.



Code	Dimension cm	Dimension inches	Price €
ZZTITANDSK6002	180x90x74h	70 ¹¹ / ₁₆ x 35 ¹ / ₂ x 29 ¹ / ₈ h	3627,00
ZZTITANDSK6005	200x90x74h	78 ¹ / ₄ x 35 ¹ / ₂ x 29 ¹ / ₈ h	4009,00
ZZTITANDSK6008	220x100x74h	86 ¹ / ₈ x 39 ¹ / ₈ x 29 ¹ / ₈ h	4551,00

Piano in cristallo verniciato. Travi sottopiano verniciate grigio goffrato. Giunti e gambe verniciate bianco o nero semilucido.

Top in painted glass. Beams under the top epoxy powder coated in textured grey. Joints and legs epoxy powder coated in semi-gloss white or black.

Supplemento per N° 4 giunti cromati.
Surcharge for N° 4 chromed joints.

Code	Price €
ZZTITANACCD600	297,00

Supplemento per N° 4 gambe cromate.
Surcharge for N° 4 chromed legs.

Code	Price €
ZZTITANACCD601	289,00

TITAN - Scrivanie - Desks

Supplemento per travi sottopiano cromate e N° 4 giunti cromati.
Surcharge for beams under the top chromed and N° 4 chromed joints.

Code	Price €
ZZTITANACCD602	465,00
Per scrivania an 180 - For desk 70 ¹¹ / ₁₆	
ZZTITANACCD603	846,00
Per scrivania an 200 - For desk 78 ¹ / ₄	
ZZTITANACCD604	1108,00
Per scrivania an 220 - For desk 86 ¹ / ₈	

Scrivanie con top in melaminico predisposte per mobile allungo destro o sinistro.
Desks with melamine top suitable for right or left sideboard cabinet.



Code	Dimension cm	Dimension inches	Price €
ZZTITANDSK6009	180x90x74h	70 ¹¹ / ₁₆ x 35 ¹ / ₂ x 29 ¹ / ₈ h	2508,00
ZZTITANDSK6011	200x90x74h	78 ¹ / ₄ x 35 ¹ / ₂ x 29 ¹ / ₈ h	2566,00
ZZTITANDSK6013	220x100x74h	86 ¹ / ₈ x 39 ¹ / ₈ x 29 ¹ / ₈ h	2804,00

Piano in melaminico. Travi sottopiano verniciate grigio goffrato. Giunti e gambe verniciate bianco o nero semilucido.

Top in melamine coated panel. Beams under the top epoxy powder coated in textured grey. Joints and legs epoxy powder coated in semi-gloss white or black.

Scrivanie con top in cristallo verniciato predisposte per mobile allungo destro o sinistro.
Desks with painted glass top suitable for right or left sideboard cabinet.



Code	Dimension cm	Dimension inches	Price €
ZZTITANDSK6010	180x90x74h	70 ¹¹ / ₁₆ x 35 ¹ / ₂ x 29 ¹ / ₈ h	3635,00
ZZTITANDSK6012	200x90x74h	78 ¹ / ₄ x 35 ¹ / ₂ x 29 ¹ / ₈ h	4021,00
ZZTITANDSK6014	220x100x74h	86 ¹ / ₈ x 39 ¹ / ₈ x 29 ¹ / ₈ h	4579,00

Piano in cristallo verniciato. Travi sottopiano verniciate grigio goffrato. Giunti e gambe verniciate bianco o nero semilucido.

Top in painted glass. Beams under the top epoxy powder coated in textured grey. Joints and legs epoxy powder coated in semi-gloss white or black.

Supplemento per N° 3 giunti cromati.
Surcharge for N° 3 chromed joints.

Code	Price €
ZZTITANACCD614	230,00

Supplemento per N° 3 gambe cromate.
Surcharge for N° 3 chromed legs.

Code	Price €
ZZTITANACCD615	224,00

TITAN - Scrivanie - Desks

Pannello di cortesia in melaminico per scrivania. Disponibile solo per scrivanie con piano in melaminico.

Melamine modesty panel for desk. Available only for desks with melamine top.



Code	Dimension cm	Dimension inches	Price €
ZZTITANACCD610	140x32x2	55 ¹ / ₈ x 12 ¹ / ₈ x 3/8	249,00
Per scrivania an 180 - For desk 70 ¹ / ₈			
ZZTITANACCD611	160x32x2	63 ¹ / ₈ x 12 ¹ / ₈ x 3/8	256,00
Per scrivania an 200 - For desk 78 ¹ / ₈			
ZZTITANACCD612	180x32x2	70 ¹ / ₈ x 12 ¹ / ₈ x 3/8	263,00
Per scrivania an 220 - For desk 86 ¹ / ₈			

Pannello in melaminico. Staffe verniciate grigio gofrato.
Melamine coated panel. Brackets epoxy powder coated in textured grey.

Vaschetta reggi cavi in metallo.
Metal cable tray.



Code	Dimension cm	Dimension inches	Price €
ZZTITANACCD613	50x18x5	19 ¹ / ₈ x 7 ¹ / ₈ x 2	129,00

Verniciata grigio gofrato.
Epoxy powder coated in textured grey.

TITAN - Mobili allungo - Sideboard cabinets

Mobile allungo destro bifacciale in melaminico con 2 ante scorrevoli in melaminico. Maniglie cromate.
Double sided right sideboard cabinet in melamine with 2 melamine sliding doors. Chromed handles.



Code	Dimension cm	Dimension inches	Price €
ZZTITANSCB6001	164x60x67,5h	64 ¹ / ₂ x 23 ¹ / ₈ x 26 ¹ / ₂ h	3176,00

Struttura sempre in melaminico bianco o nero. Top, fianchi e ante in melaminico nei colori di serie.
Structure always in black or white melamine. Top, sides and doors in melamine in the standard colors.

Mobile allungo sinistro bifacciale in melaminico con 2 ante scorrevoli in melaminico. Maniglie cromate.
Double sided left sideboard cabinet in melamine with 2 melamine sliding doors. Chromed handles.



Code	Dimension cm	Dimension inches	Price €
ZZTITANSCB6002	164x60x67,5h	64 ¹ / ₂ x 23 ¹ / ₈ x 26 ¹ / ₂ h	3176,00

Struttura sempre in melaminico bianco o nero. Top, fianchi e ante in melaminico nei colori di serie.
Structure always in black or white melamine. Top, sides and doors in melamine in the standard colors.

TITAN - Mobili allungo - Sideboard cabinets

Mobile allungo destro bifacciale in melaminico con 2 ante scorrevoli in cristallo verniciato. Maniglie e telaio delle ante in colore bianco, nero o argento lucido.
Double sided right sideboard cabinet in melamine with 2 painted glass sliding doors. Handles and glass door frame in white, black or shiny silver.



Code	Dimension cm	Dimension inches	Price €
ZZTITANSCB6003	164x60x67,5h	64 ¹ / ₂ x 23 ¹ / ₈ x 26 ¹ / ₂ h	3728,00

Struttura sempre in melaminico bianco o nero. Top e fianchi in melaminico nei colori di serie.
Structure always in black or white melamine. Top and sides in melamine in the standard colors.

Mobile allungo sinistro bifacciale in melaminico con 2 ante scorrevoli in cristallo verniciato. Maniglie e telaio delle ante in colore bianco, nero o argento lucido.
Double sided left sideboard cabinet in melamine with 2 painted glass sliding doors. Handles and glass door frame in white, black or shiny silver.



Code	Dimension cm	Dimension inches	Price €
ZZTITANSCB6004	164x60x67,5h	64 ¹ / ₂ x 23 ¹ / ₈ x 26 ¹ / ₂ h	3728,00

Struttura sempre in melaminico bianco o nero. Top e fianchi in melaminico nei colori di serie.
Structure always in black or white melamine. Top and sides in melamine in the standard colors.

Supplemento per base del mobile allungo in finitura cromata.
Surcharge for base of the sideboard cabinet in chromed finish.

Code	Price €
ZZTITANSCB6000	176,00

Mobile allungo destro con cassettera e vano a giorno in melaminico con 4 cassetti in melaminico. Completo di serratura a chiave; maniglie cromate.
Right sideboard cabinet with pedestal and open unit in melamine with 4 melamine drawers. Complete with key lock; chromed handles.



Code	Dimension cm	Dimension inches	Price €
ZZTITANSCB6005	84x60x67,5h	33 ¹ / ₈ x 23 ¹ / ₈ x 26 ¹ / ₂ h	2384,00

Struttura sempre in melaminico bianco o nero. Top, fianchi e frontali dei cassetti in melaminico nei colori di serie.
Structure always in black or white melamine. Top, sides and drawers fronts in melamine in the standard colors.

Mobile allungo sinistro con cassettera e vano a giorno in melaminico con 4 cassetti in melaminico. Completo di serratura a chiave; maniglie cromate.
Left sideboard cabinet with pedestal and open unit in melamine with 4 melamine drawers. Complete with key lock; chromed handles.



Code	Dimension cm	Dimension inches	Price €
ZZTITANSCB6006	84x60x67,5h	33 ¹ / ₈ x 23 ¹ / ₈ x 26 ¹ / ₂ h	2384,00

Struttura sempre in melaminico bianco o nero. Top, fianchi e frontali dei cassetti in melaminico nei colori di serie.
Structure always in black or white melamine. Top, sides and drawers fronts in melamine in the standard colors.

TITAN - Mobili allungo - Sideboard cabinets



Mobile allungo destro con cassettera e vano a giorno in melaminico con 4 cassetti in cristallo verniciato. Maniglie e telai dei cassetti in colore bianco, nero o argento lucido. Completo di serratura a chiave.
Right sideboard cabinet with pedestal and open unit in melamine with 4 painted glass drawers. Handles and glass drawers frame in white, black or shiny silver. Complete with key lock.

Code	Dimension cm	Dimension inches	Price €
ZZTITANSCB6007	84x60x67,5h	33 ¹ / ₂ x 23 ¹ / ₂ x 26 ¹ / ₂ h	3035,00

Struttura sempre in melaminico bianco o nero. Top e fianchi in melaminico nei colori di serie. Frontali dei cassetti in cristallo verniciato.
Structure always in black or white melamine. Top and sides in melamine in the standard colors. Doors in painted glass.



Mobile allungo sinistro con cassettera e vano a giorno in melaminico con 4 cassetti in cristallo verniciato. Maniglie e telai dei cassetti in colore bianco, nero o argento lucido. Completo di serratura a chiave.
Left sideboard cabinet with pedestal and open unit in melamine with 4 painted glass drawers. Handles and glass drawers frame in white, black or shiny silver. Complete with key lock.

Code	Dimension cm	Dimension inches	Price €
ZZTITANSCB6008	84x60x67,5h	33 ¹ / ₂ x 23 ¹ / ₂ x 26 ¹ / ₂ h	3035,00

Struttura sempre in melaminico bianco o nero. Top e fianchi in melaminico nei colori di serie. Frontali dei cassetti in cristallo verniciato.
Structure always in black or white melamine. Top and sides in melamine in the standard colors. Doors in painted glass.

Supplemento per base del mobile allungo in finitura cromata.
Surcharge for base of the sideboard cabinet in chromed finish.

Code	Price €
ZZTITANSCB6000	176,00

TITAN - Tavoli riunione - Meeting tables



Tavolo riunione rettangolare con top in melaminico.
Rectangular conference table with melamine top.

Code	Dimension cm	Dimension inches	Price €
ZZTITANMTB6020	240x124x74h	94 ¹ / ₂ x 48 ¹ / ₄ x 29 ¹ / ₂ h	3061,00

Piano in melaminico. Travi sottopiano verniciate grigio goffrato. Giunti e gambe verniciate bianco o nero semilucido.
Top in melamine coated panel. Beams under the top epoxy powder coated in textured grey. Joints and legs epoxy powder coated in semi-gloss white or black.



Tavolo riunione rettangolare con top in cristallo extrachiaro.
Rectangular conference table with extra-clear glass top.

Code	Dimension cm	Dimension inches	Price €
ZZTITANMTB6021	240x124x74h	94 ¹ / ₂ x 48 ¹ / ₄ x 29 ¹ / ₂ h	5725,00

Piano in cristallo extrachiaro. Travi sottopiano, giunti e gambe verniciate bianco o nero semilucido.
Top in extra-clear glass. Beams under the top, joints and legs epoxy powder coated in semi-gloss white or black.

TITAN - Tavoli riunione - Meeting tables



Tavolo riunione rettangolare con top in cristallo verniciato.
Rectangular conference table with painted glass top.

Code	Dimension cm	Dimension inches	Price €
ZZTITANMTB6022	240x124x74h	94 ¹ / ₂ x 48 ¹ / ₄ x 29 ¹ / ₂ h	5503,00

Piano in cristallo verniciato. Travi sottopiano verniciate grigio goffrato. Giunti e gambe verniciate bianco o nero semilucido.
Top in painted glass. Beams under the top epoxy powder coated in textured grey. Joints and legs epoxy powder coated in semi-gloss white or black.



Tavolo riunione quadrato con top in melaminico.
Square conference table with melamine top.

Code	Dimension cm	Dimension inches	Price €
ZZTITANMTB6023	160x164x74h	63" x 64 ¹ / ₂ x 29 ¹ / ₂ h	2820,00

Piano in melaminico. Travi sottopiano verniciate grigio goffrato. Giunti e gambe verniciate bianco o nero semilucido.
Top in melamine coated panel. Beams under the top epoxy powder coated in textured grey. Joints and legs epoxy powder coated in semi-gloss white or black.



Tavolo riunione quadrato top in cristallo extrachiaro.
Square conference table with extra-clear glass top.

Code	Dimension cm	Dimension inches	Price €
ZZTITANMTB6024	160x164x74h	63" x 64 ¹ / ₂ x 29 ¹ / ₂ h	5355,00

Piano in cristallo extrachiaro. Travi sottopiano, giunti e gambe verniciate bianco o nero semilucido.
Top in extra-clear glass. Beams under the top, joints and legs epoxy powder coated in semi-gloss white or black.



Tavolo riunione quadrato con top in cristallo verniciato.
Square conference table with painted glass top.

Code	Dimension cm	Dimension inches	Price €
ZZTITANMTB6025	160x164x74h	63" x 64 ¹ / ₂ x 29 ¹ / ₂ h	5000,00

Piano in cristallo verniciato. Travi sottopiano verniciate grigio goffrato. Giunti e gambe verniciate bianco o nero semilucido.
Top in painted glass. Beams under the top epoxy powder coated in textured grey. Joints and legs epoxy powder coated in semi-gloss white or black.

Supplemento per travi sottopiano cromate e N° 4 giunti cromati.
Surcharge for beams under the top chromed and N° 4 chromed joints.

Code	Price €
ZZTITANACCD605	1018,00

Per tavolo cm 240 - For table 94¹/₂"

Code	Price €
ZZTITANACCD606	952,00

Per tavolo cm 160 - For table 63"

Supplemento per N° 4 giunti cromati.
Surcharge for N° 4 chromed joints.

Code	Price €
ZZTITANACCD600	297,00

TITAN - Tavoli riunione - Meeting tables

Supplemento per N° 4 gambe cromate.
Surcharge for N° 4 chromed legs.

Code	Price €
ZZTITANACCD601	289,00



Tavolo riunione tondo con top in melaminico.
Round conference table with melamine top.

Code	Dimension cm	Dimension inches	Price €
ZZTITANMTB6026	∅ 140x74h	∅ 55 ¹ / ₈ x 29 ¹ / ₈ h	2093,00

Piano in melaminico. Travi sottopiano verniciate grigio gofrato. Giunti e gambe verniciate bianco o nero semilucido.
Top in melamine coated panel. Beams under the top epoxy powder coated in textured grey. Joints and legs epoxy powder coated in semi-gloss white or black.



Tavolo riunione tondo con top in cristallo extrachiaro.
Round conference table with extra-clear glass top.

Code	Dimension cm	Dimension inches	Price €
ZZTITANMTB6027	∅ 140x74h	∅ 55 ¹ / ₈ x 29 ¹ / ₈ h	3998,00

Piano in cristallo extrachiaro. Travi sottopiano, giunti e gambe verniciate bianco o nero semilucido.
Top in extra-clear glass. Beams under the top, joints and legs epoxy powder coated in semi-gloss white or black.



Tavolo riunione tondo con top in cristallo verniciato.
Round conference table with painted glass top.

Code	Dimension cm	Dimension inches	Price €
ZZTITANMTB6028	∅ 140x74h	∅ 55 ¹ / ₈ x 29 ¹ / ₈ h	3600,00

Piano in cristallo verniciato. Travi sottopiano verniciate grigio gofrato. Giunti e gambe verniciate bianco o nero semilucido.
Top in painted glass. Beams under the top epoxy powder coated in textured grey. Joints and legs epoxy powder coated in semi-gloss white or black.

Supplemento per travi sottopiano cromate e N° 3 giunti cromati.
Surcharge for beams under the top chromed and N° 3 chromed joints.

Code	Price €
ZZTITANACCD607	406,00

Per tavolo ∅ cm 140 - For table ∅ 55¹/₈

Supplemento per N° 3 giunti cromati.
Surcharge for N° 3 chromed joints.

Code	Price €
ZZTITANACCD614	230,00

Supplemento per N° 3 gambe cromate.
Surcharge for N° 3 chromed legs.

Code	Price €
ZZTITANACCD615	224,00

TITAN - Cassettiera su ruote - Pedestal on casters



Cassettiera su ruote in metallo con 3 cassetti dotati di serratura e vaschetta portacancelleria.
Chest of drawers on casters in metal with 3 drawers with lock and stationery tray.

Code	Dimension cm	Dimension inches	Price €
ZZTITANSPD6000	43x55x60h	16 ¹ / ₈ x 21 ¹ / ₈ x 23 ¹ / ₈ h	766,00

Struttura in metallo bianco o nero semilucido.
Metal structure epoxy powder coated in semi-gloss white or black.



Cassettiera su ruote in metallo cromato con 3 cassetti dotati di serratura e vaschetta portacancelleria.
Chest of drawers on casters in chromed metal with 3 drawers with lock and stationery tray.

Code	Dimension cm	Dimension inches	Price €
ZZTITANSPD6001	43x55x60h	16 ¹ / ₈ x 21 ¹ / ₈ x 23 ¹ / ₈ h	2771,00

Struttura in metallo cromato.
Metal chromed structure.

**SCRIVANIE OPERATIVE
OPERATIVE DESKS**

LINE



La struttura portante delle scrivanie è costituita da una coppia di monorotaie sottopiano in acciaio verniciato, a cui sono fissati i basamenti in tubolare metallico rettangolare 30 x 70 mm verniciati a polveri epossidiche in colore bianco opaco (RAL 9010) o nero opaco (RAL 9005) e disponibili in tre tipologie: gamba aperta, gamba chiusa e gamba inclinata. Per tutte le tipologie di basamento sono disponibili sia scrivanie singole che scrivanie doppie, con 2 piani simmetrici distanziati fra loro per consentire l'eventuale passaggio dei cavi e l'alloggio di schermi frontali. Per ogni scrivania è anche disponibile l'allungo laterale fissato da un lato ad un basamento e dall'altro al piano adiacente. I piani delle scrivanie sono in melaminico spessore 25 mm in diverse finiture. Sono disponibili pannelli di cortesia in melaminico e in acciaio e schermi frontali divisorii in melaminico.

The supporting structure of the desks consists of a pair of powder coated steel monorails placed under the top, to which the 30 x 70 mm rectangular tubular metal bases epoxy powder coated in matt white (RAL 9010) or matt black (RAL 9005) are fixed. The metal bases are available in three types: open leg, closed leg and inclined leg. For all base types, both single and double-depth desks are available, with 2 symmetrical tops spaced apart to allow the possible passage of cables and the housing of front screens. For each desk there is also a lateral extension fixed on one side to a base and on the other to the adjacent top. The tops of desks are in melamine coated panel thickness 25 mm. in different finishes. Modesty panels in melamine and steel are available and also front dividing screens in melamine.



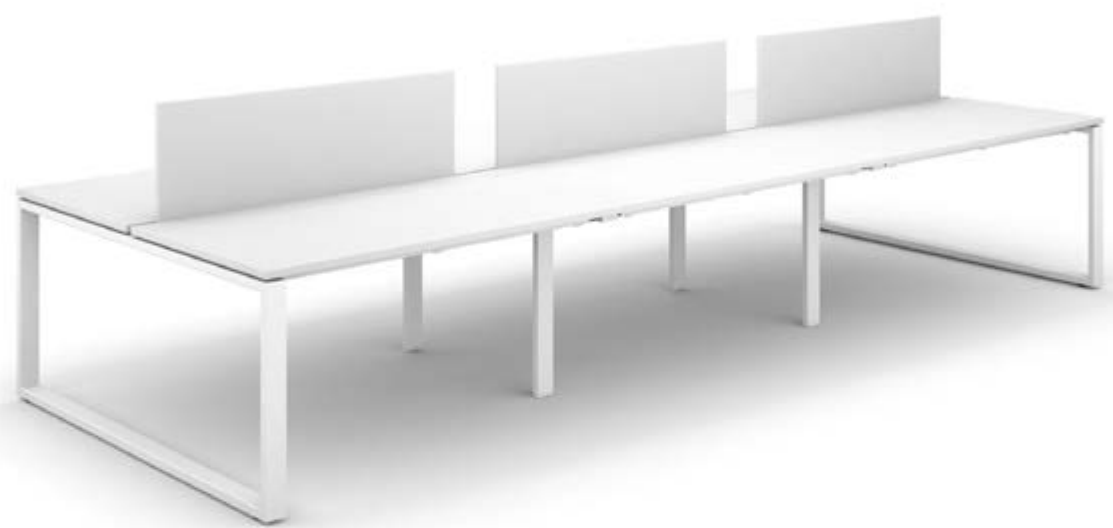



BASAMENTO CHIUSO | CLOSED BASE



BASAMENTO APERTO | OPEN BASE



BASAMENTO INCLINATO | INCLINED BASE



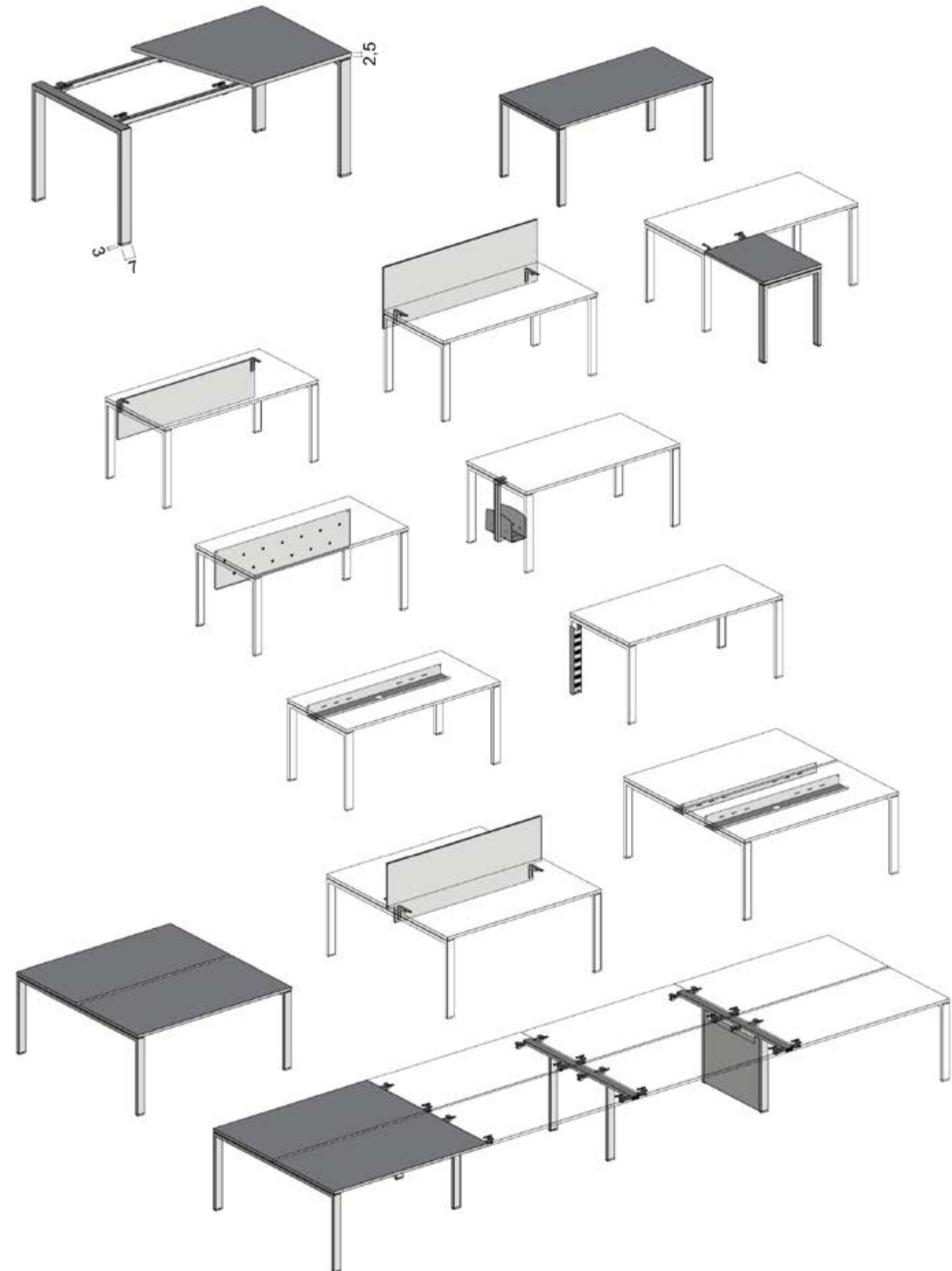

BASAMENTO INCLINATO | INCLINED BASE



LINE - Finiture disponibili - Available finishes

Piani scrivanie ed elementi in melaminico - Desk tops and melamine elements



Lino FA41



Noce Chiaro LM01



Rovere Grigio LG18



Rovere Bianco LK84



Noce Canaletto LN83



Rovere Spessart LM76



Rovere Magister LK97



Ash S001



Bianco B007



Grigio U110

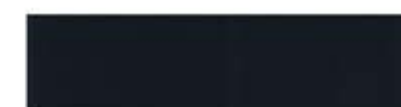

Nero U129



Avorio U100



Grafite UB08

Parti metalliche verniciate a polveri epossidiche - Metal parts epoxy powder coated



Bianco opaco RAL 9010
Matt white RAL 9010

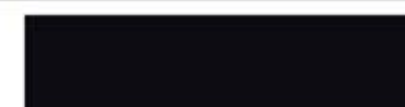

Nero opaco RAL 9005
Matt black RAL 9005

LINE - Scrivanie e allunghi - Desks and extensions



Scrivanie singole con basamento aperto.
Single desks with open base.

Code	Dimension cm	Dimension inches	Price €
ZZLINEEDSK1100	140x80x73h	55 ¹³ / ₁₆ x 31 ¹ / ₂ x 28 ³ / ₄ h	736,00
ZZLINEEDSK1101	160x80x73h	63 ¹ / ₂ x 31 ¹ / ₂ x 28 ³ / ₄ h	751,00
ZZLINEEDSK1102	180x80x73h	70 ⁷ / ₁₆ x 31 ¹ / ₂ x 28 ³ / ₄ h	800,00

Piano in melaminico. Base verniciata bianco opaco (RAL 9010) o nero opaco (RAL 9005).
Top in melamine coated panel. Base epoxy powder coated in matt white (RAL 9010) or matt black (RAL 9005).



Scrivanie singole con basamento chiuso.
Single desks with closed base.

Code	Dimension cm	Dimension inches	Price €
ZZLINEEDSK1200	140x80x73h	55 ¹³ / ₁₆ x 31 ¹ / ₂ x 28 ³ / ₄	849,00
ZZLINEEDSK1201	160x80x73h	63 ¹ / ₂ x 31 ¹ / ₂ x 28 ³ / ₄	864,00
ZZLINEEDSK1202	180x80x73h	70 ⁷ / ₁₆ x 31 ¹ / ₂ x 28 ³ / ₄	913,00

Piano in melaminico. Base verniciata bianco opaco (RAL 9010) o nero opaco (RAL 9005).
Top in melamine coated panel. Base epoxy powder coated in matt white (RAL 9010) or matt black (RAL 9005).



Scrivanie singole con basamento inclinato.
Single desks with inclined base.

Code	Dimension cm	Dimension inches	Price €
ZZLINEEDSK1300	140x80x73h	55 ¹³ / ₁₆ x 31 ¹ / ₂ x 28 ³ / ₄	736,00
ZZLINEEDSK1301	160x80x73h	63 ¹ / ₂ x 31 ¹ / ₂ x 28 ³ / ₄	751,00
ZZLINEEDSK1302	180x80x73h	70 ⁷ / ₁₆ x 31 ¹ / ₂ x 28 ³ / ₄	800,00

Piano in melaminico. Base verniciata bianco opaco (RAL 9010) o nero opaco (RAL 9005).
Top in melamine coated panel. Base epoxy powder coated in matt white (RAL 9010) or matt black (RAL 9005).



Allungo con basamento aperto.
Extension with open base.

Code	Dimension cm	Dimension inches	Price €
ZZLINEEDSK1103	80x60x73h	31 ¹ / ₂ x 23 ⁹ / ₁₆ x 28 ³ / ₄	491,00

Piano in melaminico. Base verniciata bianco opaco (RAL 9010) o nero opaco (RAL 9005).
Top in melamine coated panel. Base epoxy powder coated in matt white (RAL 9010) or matt black (RAL 9005).



Allungo con basamento chiuso.
Extension with closed base.

Code	Dimension cm	Dimension inches	Price €
ZZLINEEDSK1203	80x60x73h	31 ¹ / ₂ x 23 ⁹ / ₁₆ x 28 ³ / ₄	545,00

Piano in melaminico. Base verniciata bianco opaco (RAL 9010) o nero opaco (RAL 9005).
Top in melamine coated panel. Base epoxy powder coated in matt white (RAL 9010) or matt black (RAL 9005).

LINE - Scrivanie e allunghi - Desks and extensions



Allungo con basamento inclinato.
Extension with inclined base.

Code	Dimension cm	Dimension inches	Price €
ZZLINEEDSK1303	80x60x73h	31 ¹ / ₂ x 23 ⁹ / ₁₆ x 28 ³ / ₄	491,00

Piano in melaminico. Base verniciata bianco opaco (RAL 9010) o nero opaco (RAL 9005).
Top in melamine coated panel. Base epoxy powder coated in matt white (RAL 9010) or matt black (RAL 9005).



Canalina in acciaio per scrivania con basamento aperto, chiuso o inclinato.
Metal channel for desk with open, closed or inclined base.

Code	Lunghezza cm	Length inches	Price €
ZZLINEEACCD100	120	47 ¹ / ₄	113,00
Per scrivania an 140 - For desk 55 ¹³ / ₁₆			
ZZLINEEACCD101	140	55 ¹³ / ₁₆	113,00
Per scrivania an 160 - For desk 63 ¹ / ₂			
ZZLINEEACCD102	160	63 ¹ / ₂	125,00
Per scrivania an 180 - For desk 70 ⁷ / ₁₆			

Verniciata bianco opaco (RAL 9010) o nero opaco (RAL 9005).
Epoxy powder coated in matt white (RAL 9010) or matt black (RAL 9005).



Pannello di cortesia in acciaio per scrivania con basamento aperto, chiuso o inclinato.
Metal modesty panel for desk with open, closed or inclined base.

Code	Dimension cm	Dimension inches	Price €
ZZLINEEACCD103	122x35	48 ¹ / ₂ x 13 ³ / ₄	156,00
Per scrivania an 140 - For desk 55 ¹³ / ₁₆			
ZZLINEEACCD104	142x35	55 ¹³ / ₁₆ x 13 ³ / ₄	168,00
Per scrivania an 160 - For desk 63 ¹ / ₂			
ZZLINEEACCD105	162x35	63 ¹ / ₄ x 13 ³ / ₄	176,00
Per scrivania an 180 - For desk 70 ⁷ / ₁₆			

Verniciata bianco opaco (RAL 9010) o nero opaco (RAL 9005).
Epoxy powder coated in matt white (RAL 9010) or matt black (RAL 9005).



Pannello di cortesia in melaminico per scrivania con basamento aperto o chiuso. Completo di 2 staffe per il fissaggio.
Melamine modesty panel for desk with open or closed base. Complete with 2 fixing brackets.

Code	Dimension cm	Dimension inches	Price €
ZZLINEEACCD106	122x35	48 ¹ / ₂ x 13 ³ / ₄	249,00
Per scrivania an 140 - For desk 55 ¹³ / ₁₆			
ZZLINEEACCD107	142x35	55 ¹³ / ₁₆ x 13 ³ / ₄	257,00
Per scrivania an 160 - For desk 63 ¹ / ₂			
ZZLINEEACCD108	162x35	63 ¹ / ₄ x 13 ³ / ₄	265,00
Per scrivania an 180 - For desk 70 ⁷ / ₁₆			

Pannello in melaminico. Staffe verniciate bianco opaco (RAL 9010) o nero opaco (RAL 9005).
Melamine coated panel. Brackets epoxy powder coated in matt white (RAL 9010) or matt black (RAL 9005).

LINE - Scrivanie e allunghi - Desks and extensions



Pannello di cortesia in melaminico per scrivania con basamento inclinato. Completo di 2 staffe per il fissaggio.

Melamine modesty panel for desk with indined base. Complete with 2 fixing brackets.

Code	Dimension cm	Dimension inches	Price €
ZZLINEEACCD120	122x35	48" x 13 ³ / ₄ "	249,00
Per scrivania an 140 - For desk 55" ⁹			
ZZLINEEACCD121	142x35	55 ⁷ / ₈ " x 13 ³ / ₄ "	257,00
Per scrivania an 160 - For desk 63"			
ZZLINEEACCD122	162x35	63 ³ / ₄ " x 13 ³ / ₄ "	265,00
Per scrivania an 180 - For desk 70" ⁹			

Pannello in melaminico. Staffe verniciate bianco opaco (RAL 9010) o nero opaco (RAL 9005).
Melamine coated panel. Brackets epoxy powder coated in matt white (RAL 9010) or matt black (RAL 9005).



Schermo frontale in melaminico per scrivania con basamento aperto o chiuso. Completo di 2 staffe per il fissaggio.

Melamine front screen panel for desk with open or closed base. Complete with 2 fixing brackets.

Code	Dimension cm	Dimension inches	Price €
ZZLINEEACCD109	140x55x1,9	55 ¹ / ₈ " x 21 ⁵ / ₈ " x 3/4"	276,00
Per scrivania an 140 - For desk 55" ⁹			
ZZLINEEACCD110	160x55x1,9	63" x 21 ⁵ / ₈ " x 3/4"	287,00
Per scrivania an 160 - For desk 63"			
ZZLINEEACCD111	180x55x1,9	70 ³ / ₈ " x 21 ⁵ / ₈ " x 3/4"	297,00
Per scrivania an 180 - For desk 70" ⁹			

Pannello in melaminico. Staffe verniciate bianco opaco (RAL 9010) o nero opaco (RAL 9005).
Melamine coated panel. Brackets epoxy powder coated in matt white (RAL 9010) or matt black (RAL 9005).



Schermo frontale in melaminico per scrivania con basamento inclinato. Completo di 2 staffe per il fissaggio.

Melamine front screen panel for desk with indined base. Complete with 2 fixing brackets.

Code	Dimension cm	Dimension inches	Price €
ZZLINEEACCD123	140x55x1,9	55 ¹ / ₈ " x 21 ⁵ / ₈ " x 3/4"	278,00
Per scrivania an 140 - For desk 55" ⁹			
ZZLINEEACCD124	160x55x1,9	63" x 21 ⁵ / ₈ " x 3/4"	289,00
Per scrivania an 160 - For desk 63"			
ZZLINEEACCD125	180x55x1,9	70 ³ / ₈ " x 21 ⁵ / ₈ " x 3/4"	299,00
Per scrivania an 180 - For desk 70" ⁹			

Pannello in melaminico. Staffe verniciate bianco opaco (RAL 9010) o nero opaco (RAL 9005).
Melamine coated panel. Brackets epoxy powder coated in matt white (RAL 9010) or matt black (RAL 9005).



Canalina in lamiera verniciata bianca o nera opaca per solo basamento chiuso o aperto.
Duct in matt black or white painted sheet for dosed or open base only.

Code	Price €
ZZCOMELFTD119	63,00

LINE - Scrivanie e allunghi - Desks and extensions



Porta CPU in lamiera da fissare alla struttura. Disponibile verniciato a polveri epossidiche in colore bianco o nero opaco.

CPU holder in sheet metal to be fixed to the desk frame. Available painted with epoxy powders in white or matt black.

Code	Price €
ZZCOMELFTD123	180,00

LINE - Scrivanie doppie - Double desks



Coppia di piani in melaminico per scrivanie doppie con profondità 122 cm (prezzo per 2 piani).

Pair of melamine tops for double desks with 122 cm depth (price for 2 tops).

Code	Dimension cm	Dimension inches	Price €
ZZLINEEDSK1000	120x60x2,5	47 ¹ / ₈ " x 23 ⁵ / ₈ " x 1"	409,00
ZZLINEEDSK1001	140x60x2,5	55 ³ / ₈ " x 23 ⁵ / ₈ " x 1"	463,00
ZZLINEEDSK1002	160x60x2,5	63" x 23 ⁵ / ₈ " x 1"	475,00
ZZLINEEDSK1003	180x60x2,5	70 ³ / ₈ " x 23 ⁵ / ₈ " x 1"	533,00

Piano in melaminico.
Top in melamine coated panel.



Coppia di piani in melaminico per scrivanie doppie con profondità 162 cm (prezzo per 2 piani).

Pair of melamine tops for double desks with 162 cm depth (price for 2 tops).

Code	Dimension cm	Dimension inches	Price €
ZZLINEEDSK1004	140x80x2,5	55 ³ / ₈ " x 31 ¹ / ₂ " x 1"	485,00
ZZLINEEDSK1005	160x80x2,5	63" x 31 ¹ / ₂ " x 1"	500,00
ZZLINEEDSK1006	180x80x2,5	70 ³ / ₈ " x 31 ¹ / ₂ " x 1"	561,00

Piano in melaminico.
Top in melamine coated panel.



Coppia di basamenti terminali aperti per scrivanie doppie (prezzo per 2 gambe).

Code	Profondità cm	Depth inches	Price €
ZZLINEEDSK1104	122	48"	620,00
ZZLINEEDSK1105	162	63 ³ / ₄ "	644,00

Verniciate bianco opaco (RAL 9010) o nero opaco (RAL 9005).
Epoxy powder coated in matt white (RAL 9010) or matt black (RAL 9005).



Coppia di basamenti terminali chiusi per scrivanie doppie (prezzo per 2 gambe).

Code	Profondità cm	Depth inches	Price €
ZZLINEEDSK1204	122	48"	753,00
ZZLINEEDSK1205	162	63 ³ / ₄ "	862,00

Verniciate bianco opaco (RAL 9010) o nero opaco (RAL 9005).
Epoxy powder coated in matt white (RAL 9010) or matt black (RAL 9005).

LINE - Scrivanie doppie - Double desks



Coppia di basamenti terminali inclinati per scrivanie doppie (prezzo per 2 gambe).
Pair of end inclined bases for double desks (price for 2 legs).

Code	Profondità cm	Depth inches	Price €
ZZLINEEDSK1304	122	48"	620,00
ZZLINEEDSK1305	162	63 ³ / ₄ "	644,00

Verniciate bianco opaco (RAL 9010) o nero opaco (RAL 9005).
Epoxy powder coated in matt white (RAL 9010) or matt black (RAL 9005).

Basamento intermedio diritto per scrivanie doppie.
Straight intermediate base for double desks.



Code	Dimension cm	Dimension inches	Price €
ZZLINEEDSK1106			437,00
Per profondità cm 122 - For depth 48"			
ZZLINEEDSK1107			437,00
Per profondità cm 162 - For depth 63 ³ / ₄ "			

Verniciato bianco opaco (RAL 9010) o nero opaco (RAL 9005).
Epoxy powder coated in matt white (RAL 9010) or matt black (RAL 9005).

Kit copricavi in lamiera per basamento intermedio diritto per scrivanie doppie.
Sheet metal cable cover kit for straight intermediate base for double desks.



Code	Dimension cm	Dimension inches	Price €
ZZLINEEDSK1108			176,00
Per profondità cm 122 - For depth 48"			
ZZLINEEDSK1109			222,00
Per profondità cm 162 - For depth 63 ³ / ₄ "			

Verniciato bianco opaco (RAL 9010) o nero opaco (RAL 9005).
Epoxy powder coated in matt white (RAL 9010) or matt black (RAL 9005).

Basamento intermedio inclinato per scrivanie doppie.
Intermediate inclined base for double desks.



Code	Dimension cm	Dimension inches	Price €
ZZLINEEDSK1306			437,00
Per profondità cm 122 - For depth 48"			
ZZLINEEDSK1307			437,00
Per profondità cm 162 - For depth 63 ³ / ₄ "			

Verniciato bianco opaco (RAL 9010) o nero opaco (RAL 9005).
Epoxy powder coated in matt white (RAL 9010) or matt black (RAL 9005).

Kit copricavi in lamiera per basamento intermedio inclinato per scrivanie doppie.
Sheet metal cable cover kit for inclined intermediate base for double desks.



Code	Dimension cm	Dimension inches	Price €
ZZLINEEDSK1308			176,00
Per profondità cm 122 - For depth 48"			
ZZLINEEDSK1309			226,00
Per profondità cm 162 - For depth 63 ³ / ₄ "			

Verniciato bianco opaco (RAL 9010) o nero opaco (RAL 9005).
Epoxy powder coated in matt white (RAL 9010) or matt black (RAL 9005).

LINE - Scrivanie doppie - Double desks



Coppia di canaline in acciaio per scrivanie doppie (prezzo per 2 canaline).
Pair of metal channel for double desks (price for 2 channels).

Code	Lunghezza cm	Length inches	Price €
ZZLINEEACCD112	100	39 ¹ / ₂ "	180,00
Per scrivania cm 120 - For desk 47 ³ / ₄ "			
ZZLINEEACCD113	120	47 ¹ / ₄ "	195,00
Per scrivania cm 140 - For desk 55 ⁵ / ₈ "			
ZZLINEEACCD114	140	55 ³ / ₈ "	195,00
Per scrivania cm 160 - For desk 63"			
ZZLINEEACCD115	160	63"	219,00
Per scrivania cm 180 - For desk 70 ⁵ / ₈ "			

Verniciate bianco opaco (RAL 9010) o nero opaco (RAL 9005).
Epoxy powder coated in matt white (RAL 9010) or matt black (RAL 9005).

Schermo frontale in melaminico per scrivania doppia con basamento aperto o chiuso. Completo di 4 staffe per il fissaggio.
Melamine front screen panel for double desks with open or closed base. Complete with 4 fixing brackets.



Code	Dimension cm	Dimension inches	Price €
ZZLINEEACCD116	120x55x1,9	47 ¹ / ₄ " x 21 ⁵ / ₈ " x 3/4"	316,00
Per scrivania cm 120 - For desk 47 ³ / ₄ "			
ZZLINEEACCD117	140x55x1,9	55 ³ / ₈ " x 21 ⁵ / ₈ " x 3/4"	326,00
Per scrivania cm 140 - For desk 55 ⁵ / ₈ "			
ZZLINEEACCD118	160x55x1,9	63" x 21 ⁵ / ₈ " x 3/4"	337,00
Per scrivania cm 160 - For desk 63"			
ZZLINEEACCD119	180x55x1,9	70 ⁵ / ₈ " x 21 ⁵ / ₈ " x 3/4"	348,00
Per scrivania cm 180 - For desk 70 ⁵ / ₈ "			

Pannello in melaminico. Staffe verniciate bianco opaco (RAL 9010) o nero opaco (RAL 9005).
Melamine coated panel. Brackets epoxy powder coated in matt white (RAL 9010) or matt black (RAL 9005).

Schermo frontale in melaminico per scrivania doppia con basamento indinato. Completo di 4 staffe per il fissaggio.
Melamine front screen panel for double desks with indined base. Complete with 4 fixing brackets.



Code	Dimension cm	Dimension inches	Price €
ZZLINEEACCD126	120x55x1,9	47 ¹ / ₄ " x 21 ⁵ / ₈ " x 3/4"	320,00
Per scrivania cm 120 - For desk 47 ³ / ₄ "			
ZZLINEEACCD127	140x55x1,9	55 ³ / ₈ " x 21 ⁵ / ₈ " x 3/4"	330,00
Per scrivania cm 140 - For desk 55 ⁵ / ₈ "			
ZZLINEEACCD128	160x55x1,9	63" x 21 ⁵ / ₈ " x 3/4"	341,00
Per scrivania cm 160 - For desk 63"			
ZZLINEEACCD129	180x55x1,9	70 ⁵ / ₈ " x 21 ⁵ / ₈ " x 3/4"	352,00
Per scrivania cm 180 - For desk 70 ⁵ / ₈ "			

Pannello in melaminico. Staffe verniciate bianco opaco (RAL 9010) o nero opaco (RAL 9005).
Melamine coated panel. Brackets epoxy powder coated in matt white (RAL 9010) or matt black (RAL 9005).

ELEVATE



Il modello Elevate è costituito da due tipologie di scrivanie.

Nella versione scrivania con piano ribaltabile la struttura portante è costituita da una monorotaia sottopiano in acciaio verniciato, a cui è fissato il montante verticale in tubolare metallico che a terra appoggia su un piede con alle estremità due ruote frenanti. Il sistema di ribaltamento è garantito da tiranti fissati a due maniglie sotto al piano; per sbloccare e sollevare il piano occorre tirare le maniglie, ruotarle di 90° e agganciarle al piano stesso.

Tutte le parti metalliche sono verniciate a polveri epossidiche in colore bianco opaco (RAL 9010), nero opaco (RAL 9005) oppure alluminio (RAL 9006). I piani delle scrivanie sono in melaminico spessore 25 mm in diverse finiture.

Nella versione scrivania con piano regolabile in altezza elettricamente la struttura portante è costituita da due travi sottopiano in acciaio verniciato, a cui sono fissati i due montanti telescopici verticali in tubolare metallico che poggiano a terra su un piede in acciaio. I due montanti telescopici verticali sono dotati di un meccanismo elettrico integrato che è in grado di sollevare il piano all'altezza desiderata compresa fra 64 cm e 129 cm. Tutte le parti metalliche sono verniciate a polveri epossidiche in colore bianco lucido (RAL 9003), nero opaco (RAL 9005) oppure alluminio (RAL 9006). Il movimento è comandato tramite due pulsanti fissati sul bordo della scrivania. E' disponibile come optional un display con posizioni memorizzabili. Il motore elettrico puo' sollevare al massimo un peso di 1200 N. Per il modello è disponibile anche un allungo con piano regolabile elettricamente in altezza e pannelli di cortesia e frontali. I piani delle scrivanie sono in melaminico spessore 25 mm in diverse finiture mentre i pannelli di cortesia sono disponibili anche in metallo.

The Elevate model consists of two types of desks.

In the folding table version, the supporting structure consists of a powder coated steel monorail placed under the top, to which is fixed the metal tube vertical upright and which rests on a steel foot in the ground with two braking wheels at the ends. The folding system is guaranteed by tie rods fixed to two handles under the top; to unlock and lift the top, pull the handles, rotate them 90° and hook them to the top. All metal parts are epoxy powder coated in matt white (RAL 9010), matt black (RAL 9005) or aluminum (RAL 9006). The desk tops are in 25 mm thick melamine in different finishes.

In the electrically heightadjustable version, the supporting structure consists of a powder coated steel beams placed under the top, to which the two vertical telescopic metal tubular uprights are fixed and rest on a steel foot in the ground. The two vertical telescopic uprights are equipped with an electric mechanism that is able to lift the top to the desired height between 64 cm and 129 cm.

All metal parts are epoxy powder painted in glossy white (RAL 9003), matt black (RAL 9005) or aluminum (RAL 9006). The movement is controlled by two buttons fixed on the edge of the desk. A display with storable positions is also available as optional.

The electric motor can lift a maximum weight of 1200 N. The model is completed with an extension with electrically adjustable height top and modesty panels and front panels. The desk tops are in 25 mm thick melamine in different finishes while the modesty panels are also available in metal.

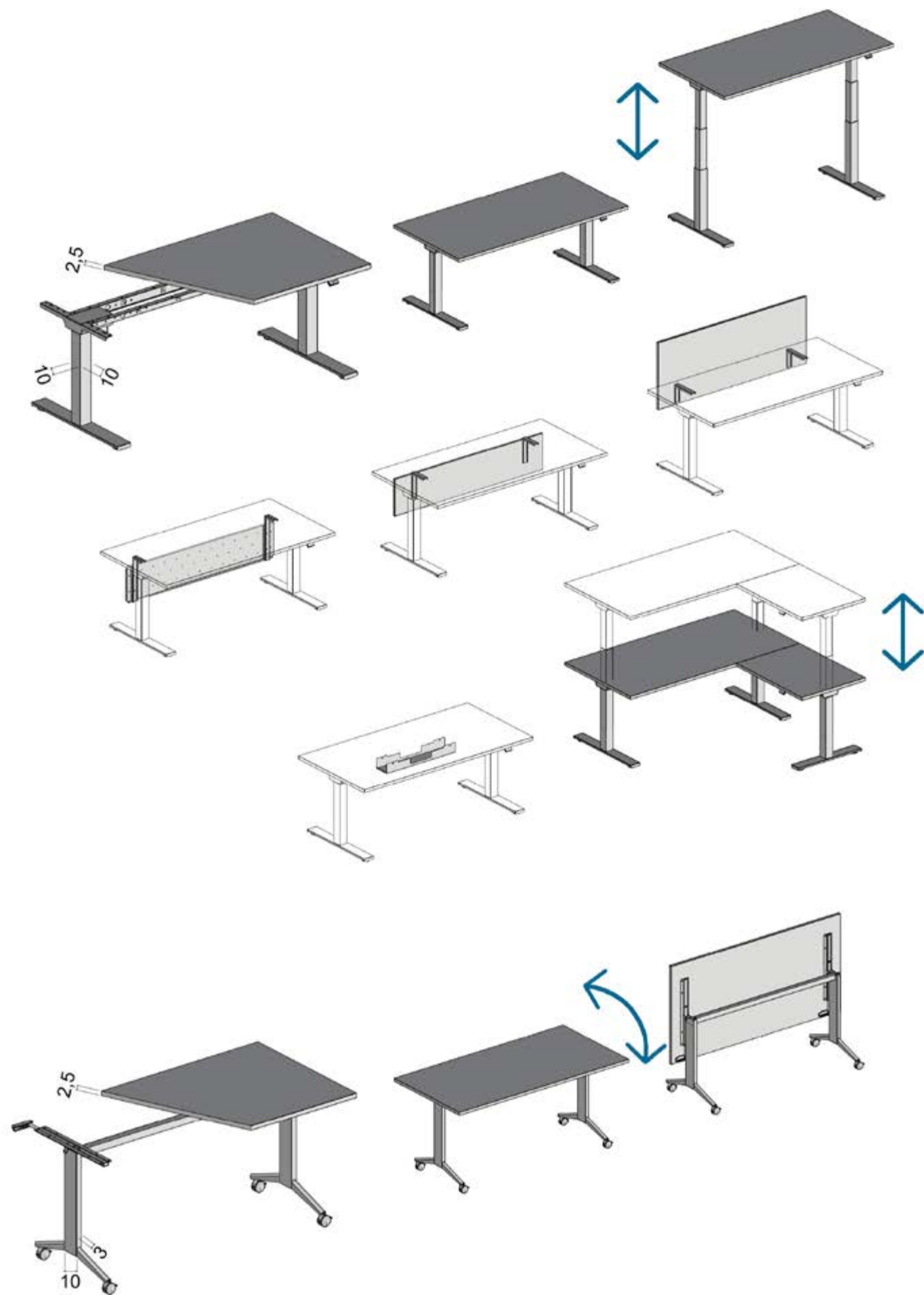

ELEVATE - Finiture disponibili - Available finishes

Piani scrivanie ed elementi in melaminico - Desk tops and melamine elements



Lino FA41



Noce Chiaro LM01



Rovere Grigio LG18



Rovere Bianco LK84



Noce Canaletto LN83



Rovere Spessart LM76



Rovere Magister LK97



Ash S001



Bianco B007



Grigio U110

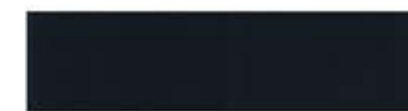

Nero U129



Avorio U100



Grafite UB08

Parti metalliche verniciate a polveri epossidiche - Metal parts epoxy powder coated



Bianco opaco RAL 9010
Solo per la versione ribaltabile
Matt white RAL 9010
Only for folding version



Alluminio RAL 9006
Aluminum RAL 9006



Nero opaco RAL 9005
Matt black RAL 9005



Bianco lucido RAL 9003
Solo per la versione regolabile in altezza
Gloss white RAL 9003
Only for the height-adjustable version

ELEVATE - Scrivanie con piano ribaltabile - Folding desks



Scrivanie con piano ribaltabile.
Folding desks.

Code	Dimension cm	Dimension inches	Price €
ZZELEVADSK7000	140x60x74h	55 ¹ / ₈ x 23 ³ / ₈ x 29 ¹ / ₈ h	728,00
ZZELEVADSK7001	160x60x74h	63 ¹ / ₈ x 23 ³ / ₈ x 29 ¹ / ₈ h	740,00
ZZELEVADSK7002	180x60x74h	70 ¹ / ₈ x 23 ³ / ₈ x 29 ¹ / ₈ h	776,00
ZZELEVADSK7003	140x80x74h	55 ¹ / ₈ x 31 ¹ / ₂ x 29 ¹ / ₈ h	757,00
ZZELEVADSK7004	160x80x74h	63 ¹ / ₈ x 31 ¹ / ₂ x 29 ¹ / ₈ h	772,00
ZZELEVADSK7005	180x80x74h	70 ¹ / ₈ x 31 ¹ / ₂ x 29 ¹ / ₈ h	812,00

Piano in melaminico. Base verniciata bianco opaco (RAL 9010), nero opaco (RAL 9005) o alluminio (RAL 9006).
Top in melamine coated panel. Base epoxy powder coated in matt white (RAL 9010) or matt black (RAL 9005) or aluminum (RAL 9006).

ELEVATE - Scrivanie e allungo regolabile in altezza - Height adjustable desks and extension



Scrivanie regolabili in altezza elettricamente.
Electrical height adjustable desks.

Code	Dimension cm	Dimension inches	Price €
ZZELEVADSK7006	140x80x64÷129h	55 ¹ / ₈ x 31 ¹ / ₂ x 25 ¹ / ₄ +50 ¹ / ₈ h	1876,00
ZZELEVADSK7007	160x80x64÷129h	63 ¹ / ₈ x 31 ¹ / ₂ x 25 ¹ / ₄ +50 ¹ / ₈ h	1899,00
ZZELEVADSK7008	180x80x64÷129h	70 ¹ / ₈ x 31 ¹ / ₂ x 25 ¹ / ₄ +50 ¹ / ₈ h	1939,00

Piano in melaminico. Base verniciata bianco lucido (RAL 9003), nero opaco (RAL 9005) o alluminio (RAL 9006).
Motore elettrico a 220 Volt.
Top in melamine coated panel. Base epoxy powder coated in gloss white (RAL 9003) or matt black (RAL 9005) or aluminum (RAL 9006). 220 Volt electric motor.



Allungo regolabile in altezza elettricamente.
Electrical height adjustable extension.

Code	Dimension cm	Dimension inches	Price €
ZZELEVADSK7009	80x60x64÷129h	31 ¹ / ₂ x 23 ³ / ₈ x 25 ¹ / ₄ +50 ¹ / ₈ h	1356,00

Piano in melaminico. Base verniciata bianco lucido (RAL 9003), nero opaco (RAL 9005) o alluminio (RAL 9006).
Motore elettrico a 220 Volt.
Top in melamine coated panel. Base epoxy powder coated in gloss white (RAL 9003) or matt black (RAL 9005) or aluminum (RAL 9006). 220 Volt electric motor.

Supplemento per kit elettrico con display e posizioni memorizzabili.
Surcharge for electric kit with display and memory positions.

Code	Dimension cm	Dimension inches	Price €
ZZELEVAACCD700			160,00
Per scrivanie - For desks			
ZZELEVAACCD702			160,00
Per scrivanie con allungo - For desks with extension			

Supplemento per motore elettrico con 110 Volt.
Surcharge for electric motor with 110 Volt.

Code	Dimension cm	Dimension inches	Price €
ZZELEVAACCD701			176,00

ELEVATE - Scrivanie e allungo regolabile in altezza - Height adjustable desks and extension



Pannello di cortesia in acciaio per scrivania. Completo di 2 staffe per il fissaggio. Disponibile solo per scrivanie regolabili in altezza.
Metal modesty panel for desk. Complete with 2 fixing brackets. Available only for height adjustable desks.

Code	Dimension cm	Dimension inches	Price €
ZZELEVAACCD704	140x30	55 ¹ / ₈ x 11 ³ / ₈	261,00
Per scrivania cm 140 - For desk 55 ¹ / ₈			
ZZELEVAACCD705	160x30	63 ¹ / ₈ x 11 ³ / ₈	265,00
Per scrivania cm 160 - For desk 63 ¹ / ₈			
ZZELEVAACCD706	180x30	70 ¹ / ₈ x 11 ³ / ₈	289,00
Per scrivania cm 180 - For desk 70 ¹ / ₈			

Verniciata bianco lucido (RAL 9003), nero opaco (RAL 9005) o alluminio (RAL 9006).
Epoxy powder coated in gloss white (RAL 9003) or matt black (RAL 9005) or aluminum (RAL 9006).



Pannello di cortesia in melaminico per scrivania. Completo di 2 staffe per il fissaggio. Disponibile solo per scrivanie regolabili in altezza.
Melamine modesty panel for desk. Complete with 2 fixing brackets. Available only for height adjustable desks.

Code	Dimension cm	Dimension inches	Price €
ZZELEVAACCD708	140x30x1,9	55 ¹ / ₈ x 11 ³ / ₈ x 3/8	246,00
Per scrivania cm 140 - For desk 55 ¹ / ₈			
ZZELEVAACCD709	160x30x1,9	63 ¹ / ₈ x 11 ³ / ₈ x 3/8	254,00
Per scrivania cm 160 - For desk 63 ¹ / ₈			
ZZELEVAACCD710	180x30x1,9	70 ¹ / ₈ x 11 ³ / ₈ x 3/8	261,00
Per scrivania cm 180 - For desk 70 ¹ / ₈			

Pannello in melaminico. Base verniciata bianco lucido (RAL 9003), nero opaco (RAL 9005) o alluminio (RAL 9006).
Melamine coated panel. Base epoxy powder coated in gloss white (RAL 9003) or matt black (RAL 9005) or aluminum (RAL 9006).



Schermo frontale in melaminico per scrivania. Completo di 2 staffe per il fissaggio. Disponibile solo per scrivanie regolabili in altezza.
Melamine front screen panel for desk. Complete with 2 fixing brackets. Available only for height adjustable desks.

Code	Dimension cm	Dimension inches	Price €
ZZELEVAACCD712	140x55x1,9	55 ¹ / ₈ x 21 ³ / ₈ x 3/8	270,00
Per scrivania cm 140 - For desk 55 ¹ / ₈			
ZZELEVAACCD713	160x55x1,9	63 ¹ / ₈ x 21 ³ / ₈ x 3/8	281,00
Per scrivania cm 160 - For desk 63 ¹ / ₈			
ZZELEVAACCD714	180x55x1,9	70 ¹ / ₈ x 21 ³ / ₈ x 3/8	291,00
Per scrivania cm 180 - For desk 70 ¹ / ₈			

Pannello in melaminico. Base verniciata bianco lucido (RAL 9003), nero opaco (RAL 9005) o alluminio (RAL 9006).
Melamine coated panel. Base epoxy powder coated in gloss white (RAL 9003) or matt black (RAL 9005) or aluminum (RAL 9006).

ELEVATE - Canalina passacavi - Cable duct



Canalina passacavi in metallo.
Metal cable duct.

Code	Price €
ZZELEVAACCD715	121,00

FLAP



La struttura portante delle scrivanie è costituita da una monorotaia sottopiano in acciaio verniciato (che funge anche da canalina passacavi), a cui è fissato il montante verticale in tubolare metallico coperto da un carter di lamiera e che a terra appoggia su un piede di acciaio. Tutte le parti metalliche sono verniciate a polveri epossidiche in colore bianco opaco (RAL 9010), nero opaco (RAL 9005) oppure alluminio goffrato (RAL 9006).

Sono disponibili sia scrivanie rettangolari che scrivanie angolari e per ognuna di esse è disponibile anche l'allungo laterale e piani di raccordo di diverse misure. I piani delle scrivanie sono in melaminico spessore 25 mm in diverse finiture. Sono disponibili pannelli di cortesia in melaminico e in acciaio e schermi frontali divisorii in melaminico.

I tavoli riunione tondi o a botte hanno una base in tubo d'acciaio verniciata e piani in melaminico dello spessore di 25 mm.



The supporting structure of the desks consists of a powder coated steel monorail placed under the top (that acts also as a cable duct), to which the metal tube vertical upright is fixed, covered by a sheet metal casing and which rests on a steel foot on the ground. All metal parts are epoxy powder coated in matt white (RAL 9010), matt black (RAL 9005) or textured aluminum (RAL 9006). Both rectangular desks and corner desks are available, and for each of them there is also a side extension and connection tops of different sizes. The desk tops are in 25 mm thick melamine in different finishes. Modesty panels are available in melamine and steel and front dividing screens in melamine.

The round or barrel meeting tables have a painted steel tube base and melamine tops with a thickness of 25 mm.



FLAP - Finiture disponibili - Available finishes

Piani scrivanie ed elementi in melaminico - Desk tops and melamine elements



Parti metalliche verniciate a polveri epossidiche - Metal parts epoxy powder coated



FLAP - Scrivanie e allunghi - Desks and extensions

Scrivanie singole.
Single desks.



Code	Dimension cm	Dimension inches	Price €
ZZFLAPPDSK2000	140x80x73h	55 ¹¹ / ₁₆ x 31 ¹ / ₂ x 28 ³ / ₄ h	632,00
ZZFLAPPDSK2001	160x80x73h	63 ¹ / ₂ x 31 ¹ / ₂ x 28 ³ / ₄ h	651,00
ZZFLAPPDSK2002	180x80x73h	70 ⁷ / ₁₆ x 31 ¹ / ₂ x 28 ³ / ₄ h	689,00

Piano in melaminico. Base verniciata bianco opaco (RAL 9010), nero opaco (RAL 9005) o alluminio goffrato (RAL 9006).

Top in melamine coated panel. Base epoxy powder coated in matt white (RAL 9010) or matt black (RAL 9005) or textured aluminum (RAL 9006).

Scrivanie angolari destre.
Right corner desks.



Code	Dimension cm	Dimension inches	Price €
ZZFLAPPDSK2004	160x140x73h	63 ¹ / ₂ x 55 ¹¹ / ₁₆ x 28 ³ / ₄ h	1011,00
ZZFLAPPDSK2006	180x140x73h	70 ⁷ / ₁₆ x 55 ¹¹ / ₁₆ x 28 ³ / ₄ h	1066,00

Piano in melaminico. Base verniciata bianco opaco (RAL 9010), nero opaco (RAL 9005) o alluminio goffrato (RAL 9006).

Top in melamine coated panel. Base epoxy powder coated in matt white (RAL 9010) or matt black (RAL 9005) or textured aluminum (RAL 9006).

Scrivanie angolari sinistre.
Left corner desks.



Code	Dimension cm	Dimension inches	Price €
ZZFLAPPDSK2005	160x140x73h	63 ¹ / ₂ x 55 ¹¹ / ₁₆ x 28 ³ / ₄ h	1011,00
ZZFLAPPDSK2007	180x140x73h	70 ⁷ / ₁₆ x 55 ¹¹ / ₁₆ x 28 ³ / ₄ h	1066,00

Piano in melaminico. Base verniciata bianco opaco (RAL 9010), nero opaco (RAL 9005) o alluminio goffrato (RAL 9006).

Top in melamine coated panel. Base epoxy powder coated in matt white (RAL 9010) or matt black (RAL 9005) or textured aluminum (RAL 9006).

Allungo.
Extension.



Code	Dimension cm	Dimension inches	Price €
ZZFLAPPDSK2003	100x60x73h	39 ¹ / ₁₆ x 31 ¹ / ₂ x 28 ³ / ₄ h	457,00

Piano in melaminico. Base verniciata bianco opaco (RAL 9010), nero opaco (RAL 9005) o alluminio goffrato (RAL 9006).

Top in melamine coated panel. Base epoxy powder coated in matt white (RAL 9010) or matt black (RAL 9005) or textured aluminum (RAL 9006).

Scrivania dattilo singola.
Single typing desk.



Code	Dimension cm	Dimension inches	Price €
ZZFLAPPDSK2013	80x80x73h	31 ¹ / ₂ x 31 ¹ / ₂ x 28 ³ / ₄ h	573,00

Piano in melaminico. Base verniciata bianco opaco (RAL 9010), nero opaco (RAL 9005) o alluminio goffrato (RAL 9006).

Top in melamine coated panel. Base epoxy powder coated in matt white (RAL 9010) or matt black (RAL 9005) or textured aluminum (RAL 9006).

FLAP - Scrivanie e allunghi - Desks and extensions



Scrivanie con piano a 120°.
Desks with 120° top.

Code	Dimension cm	Dimension inches	Price €
ZZFLAPPDSK2008	243x140x73h	95 ⁵ / ₈ x 55 ¹ / ₈ x 28 ³ / ₈ h	1152,00

Piano in melaminico. Base verniciata bianco opaco (RAL 9010), nero opaco (RAL 9005) o alluminio goffrato (RAL 9006).
Top in melamine coated panel. Base epoxy powder coated in matt white (RAL 9010) or matt black (RAL 9005) or textured aluminum (RAL 9006).

Elemento di raccordo a 90°.
90° connection element.



Code	Dimension cm	Dimension inches	Price €
ZZFLAPPDSK2009	60x60x2,5	23 ³ / ₈ x 23 ³ / ₈ x 1"	329,00
ZZFLAPPDSK2010	80x80x2,5	31 ¹ / ₂ x 23 ³ / ₈ x 1"	351,00

Piano in melaminico. Base verniciata bianco opaco (RAL 9010), nero opaco (RAL 9005) o alluminio goffrato (RAL 9006).
Top in melamine coated panel. Base epoxy powder coated in matt white (RAL 9010) or matt black (RAL 9005) or textured aluminum (RAL 9006).

Elemento di raccordo a 180°.
180° connection element.



Code	Dimension cm	Dimension inches	Price €
ZZFLAPPDSK2011	120x40x2,5	47 ¹ / ₄ x 15 ³ / ₈ x 1"	361,00
ZZFLAPPDSK2012	160x50x2,5	63" x 15 ³ / ₈ x 1"	387,00

Piano in melaminico. Base verniciata bianco opaco (RAL 9010), nero opaco (RAL 9005) o alluminio goffrato (RAL 9006).
Top in melamine coated panel. Base epoxy powder coated in matt white (RAL 9010) or matt black (RAL 9005) or textured aluminum (RAL 9006).

Pannello di cortesia in acciaio per scrivania. Completo di 2 staffe per il fissaggio.
Metal modesty panel for desk. Complete with 2 fixing brackets.



Code	Dimension cm	Dimension inches	Price €
ZZFLAPPACCD200	120x30	47 ¹ / ₄ x 11 ³ / ₈	261,00
Per scrivania an 140 - For desk 55 ¹ / ₈ "			
ZZFLAPPACCD201	140x30	55 ¹ / ₈ x 11 ³ / ₈	261,00
Per scrivania an 160 - For desk 63"			
ZZFLAPPACCD202	160x30	63" x 11 ³ / ₈	265,00
Per scrivania an 180 - For desk 70 ¹ / ₈ "			

Pannello in acciaio. Staffe verniciate bianco opaco (RAL 9010), nero opaco (RAL 9005) o alluminio goffrato (RAL 9006).
Steel panel. Brackets epoxy powder coated in matt white (RAL 9010) or matt black (RAL 9005) or textured aluminum (RAL 9006).

FLAP - Scrivanie e allunghi - Desks and extensions



Pannello di cortesia in melaminico per scrivania. Completo di 2 staffe per il fissaggio.
Melamine modesty panel for desk. Complete with 2 fixing brackets.

Code	Dimension cm	Dimension inches	Price €
ZZFLAPPACCD203	140x30x1,9	55 ¹ / ₈ x 11 ³ / ₈ x 3/4"	249,00
Per scrivania an 140 - For desk 55 ¹ / ₈ "			
ZZFLAPPACCD204	160x30x1,9	63" x 11 ³ / ₈ x 3/4"	257,00
Per scrivania an 160 - For desk 63"			
ZZFLAPPACCD205	180x30x1,9	70 ¹ / ₈ x 11 ³ / ₈ x 3/4"	264,00
Per scrivania an 180 - For desk 70 ¹ / ₈ "			

Pannello in melaminico. Staffe verniciate bianco opaco (RAL 9010), nero opaco (RAL 9005) o alluminio goffrato (RAL 9006).
Melamine coated panel. Brackets epoxy powder coated in matt white (RAL 9010) or matt black (RAL 9005) or textured aluminum (RAL 9006).

Schermo frontale in melaminico per scrivania. Completo di 2 staffe per il fissaggio.
Melamine front screen panel for desk. Complete with 2 fixing brackets.



Code	Dimension cm	Dimension inches	Price €
ZZFLAPPACCD206	140x55x1,9	55 ¹ / ₈ x 21 ¹ / ₈ x 3/4"	273,00
Per scrivania an 140 - For desk 55 ¹ / ₈ "			
ZZFLAPPACCD207	160x55x1,9	63" x 21 ¹ / ₈ x 3/4"	284,00
Per scrivania an 160 - For desk 63"			
ZZFLAPPACCD208	180x55x1,9	70 ¹ / ₈ x 21 ¹ / ₈ x 3/4"	295,00
Per scrivania an 180 - For desk 70 ¹ / ₈ "			

Pannello in melaminico. Staffe verniciata bianco opaco (RAL 9010), nero opaco (RAL 9005) o alluminio goffrato (RAL 9006).
Melamine coated panel. Brackets epoxy powder coated in matt white (RAL 9010) or matt black (RAL 9005) or textured aluminum (RAL 9006).

Porta CPU in lamiera da fissare alla struttura. Disponibile verniciato a polveri epossidiche in colore bianco, alluminio o nero opaco.
CPU holder in sheet metal to be fixed to the desk frame. Available painted with epoxy powders in white, aluminum or matt black.



Code	Price €
ZZCOMELFTTD129	172,00

FLAP - Tavoli riunione - Meeting tables



Tavolo riunione a forma di botte.
Boat shaped meeting table.

Code	Dimension cm	Dimension inches	Price €
ZZFLAPPMTB2020	200x95x73h	78 ³ / ₈ x 37 ¹ / ₈ x 28 ³ / ₈ h	1101,00
ZZFLAPPMTB2021	280x105x73h	110 ¹ / ₄ x 41 ¹ / ₈ x 28 ³ / ₈ h	1514,00

Piano in melaminico. Base verniciata bianco opaco (RAL 9010), nero opaco (RAL 9005) o alluminio goffrato (RAL 9006).
Top in melamine coated panel. Base epoxy powder coated in matt white (RAL 9010) or matt black (RAL 9005) or textured aluminum (RAL 9006).

FLAP - Tavoli riunione - Meeting tables



Tavolo riunione rotondo.
Round meeting table.

Code	Dimension cm	Dimension inches	Price €
ZZFLAPPMTB2022	120x120x73h	47 ¹ / ₄ x 47 ¹ / ₄ x 28 ³ / ₄ h	669,00
ZZFLAPPMTB2023	150x150x73h	59" x 59" x 28 ³ / ₄ h	803,00

Piano in melaminico. Base verniciata bianco opaco (RAL 9010), nero opaco (RAL 9005) o alluminio goffrato (RAL 9006).

Top in melamine coated panel. Base epoxy powder coated in matt white (RAL 9010) or matt black (RAL 9005) or textured aluminum (RAL 9006).

SQUARE



I piani delle scrivanie sono in melaminico spessore 25 mm in diverse finiture e appoggiano su 4 gambe in alluminio millerighe. Le gambe sono dotate nella parte superiore di un elemento in nylon per aggancio al piano e nella parte inferiore di un elemento sempre in nylon per appoggio a terra regolabile. Sotto al piano della scrivania è fissata una trave strutturale verniciata a polveri epossidiche in colore alluminio (RAL 9006) che funge anche da canalina passacavi.

Sono disponibili sia scrivanie rettangolari che scrivanie angolari e per ognuna di esse è disponibile l'allungo laterale, piani di raccordo di diverse misure e anche un mobile allungo dotato di vano a giorno, 1 anta e 3 cassetti. Sono inoltre disponibili pannelli di cortesia in acciaio e schermi frontali divisorii in melaminico.

I tavoli riunione quadrato o rettangolare hanno i piani e le basi interamente realizzati in melaminico dello spessore di 25 mm. La cassetiera su ruote a 3 cassetti ha una struttura in lamiera verniciata a polveri epossidiche in colore alluminio (RAL 9006) con top e frontali dei cassetti in melaminico. E' dotata di serratura e di maniglie in alluminio e PVC colore opalino.



The desk tops are in 25 mm thick melamine in different finishes and rest on 4 ribbed aluminum legs. The legs are equipped in the upper part with a nylon element for attachment to the top and in the lower part with a nylon element for adjustable ground support. Under the desk top there is an epoxy powders coated structural beam in aluminum color (RAL 9006) which also acts as a cable tray.

Both rectangular desks and corner desks are available and for each of them are available a side extension, connection tops of different sizes and also a sideboard cabinet with an open compartment, 1 door and 3 drawers. There are also courtesy panels in steel and front dividing screens in melamine.

The square or rectangular meeting tables have tops and bases entirely made of 25 mm thick melamine.

The pedestal unit on wheels with 3 drawers has a sheet metal structure painted with epoxy powders in aluminum (RAL 9006) with melamine top and drawer fronts. It is equipped with a lock and handles in aluminum and PVC in opal color.



SQUARE - Finiture disponibili - Available finishes

Piani scrivanie ed elementi in melaminico - Desk tops and melamine elements



Gambe - Legs

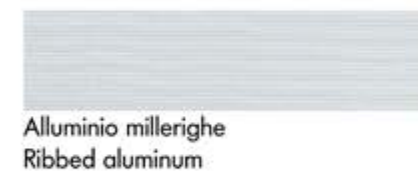

Parti metalliche verniciate a polveri epossidiche - Metal parts epoxy powder coated

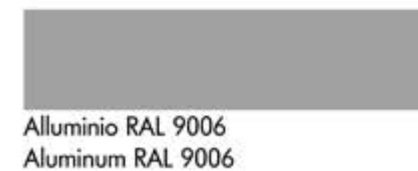

SQUARE - Scrivanie e allunghi - Desks and extensions

Scrivanie singole in melaminico.
Single desks in melamine.



Code	Dimension cm	Dimension inches	Price €
ZZSQUARDSK4000	140x80x72h	55 ¹ / ₂ " x 31 ¹ / ₂ " x 28 ¹ / ₂ "h	649,00
ZZSQUARDSK4001	160x80x72h	63" x 31 ¹ / ₂ " x 28 ¹ / ₂ "h	672,00
ZZSQUARDSK4002	180x80x72h	70 ¹ / ₂ " x 31 ¹ / ₂ " x 28 ¹ / ₂ "h	728,00

Piano in melaminico. Gambe in alluminio millerighe.
Top in melamine coated panel. Legs in ribbed aluminum.

Scrivanie angolari destre.
Right corner desks.



Code	Dimension cm	Dimension inches	Price €
ZZSQUARDSK4005	160x160x72h	63" x 63" x 28 ¹ / ₂ "h	912,00
ZZSQUARDSK4007	180x160x72h	70 ¹ / ₂ " x 63" x 28 ¹ / ₂ "h	961,00

Piano in melaminico. Gambe in alluminio millerighe.
Top in melamine coated panel. Legs in ribbed aluminum.

Scrivanie angolari sinistre.
Left corner desks.



Code	Dimension cm	Dimension inches	Price €
ZZSQUARDSK4004	160x160x72h	63" x 63" x 28 ¹ / ₂ "h	912,00
ZZSQUARDSK4006	180x160x72h	70 ¹ / ₂ " x 63" x 28 ¹ / ₂ "h	961,00

Piano in melaminico. Gambe in alluminio millerighe.
Top in melamine coated panel. Legs in ribbed aluminum.

Allungo.
Extension.



Code	Dimension cm	Dimension inches	Price €
ZZSQUARDSK4003	80x60x72h	31 ¹ / ₂ " x 23 ³ / ₈ " x 28 ¹ / ₂ "h	367,00

Piano in melaminico. Gambe in alluminio millerighe.
Top in melamine coated panel. Legs in ribbed aluminum.

Scrivanie con mobile di servizio portante destro. Mobile dotato di 1 vano a giorno, 1 anta con serratura e 3 cassetti con serratura e vaschetta porta cancelleria. Dimensione del mobile cm. 110x56x58h

Desks with right supporting sideboard cabinet. Sideboard cabinet with 1 open compartment, 1 door with lock and 3 drawers with lock and stationery tray. Cabinet size inches 43³/₄" x 22" x 22³/₈".



Code	Dimension cm	Dimension inches	Price €
ZZSQUARDSK4009	160x80x72h	63" x 31 ¹ / ₂ " x 28 ¹ / ₂ "h	2252,00
ZZSQUARDSK4011	180x80x72h	70 ¹ / ₂ " x 31 ¹ / ₂ " x 28 ¹ / ₂ "h	2271,00

Piano in melaminico. Gambe in alluminio millerighe. Mobile di servizio completamente in melaminico
Top in melamine coated panel. Legs in ribbed aluminum. Sideboard cabinet completely in melamine

SQUARE - Scrivanie e allunghi - Desks and extensions



Scrivanie con mobile di servizio portante sinistro. Mobile dotato di 1 vano a giorno, 1 anta con serratura e 3 cassetti con serratura e vaschetta porta cancelleria. Dimensione del mobile cm. 110x56x58h

Desks with left supporting sideboard cabinet. Sideboard cabinet with 1 open compartment, 1 door with lock and 3 drawers with lock and stationery tray. Cabinet size inches 43¹/₄ x 22¹/₂ x 22¹/₂h

Code	Dimension cm	Dimension inches	Price €
ZZSQUARDSK4008	160x80x72h	63" x 31 ¹ / ₂ x 28 ¹ / ₂ h	2151,00
ZZSQUARDSK4010	180x80x72h	70 ¹ / ₂ x 31 ¹ / ₂ x 28 ¹ / ₂ h	2271,00

Piano in melaminico. Gambe in alluminio millerighe. Mobile di servizio completamente in melaminico
Top in melamine coated panel. Legs in ribbed aluminum. Sideboard cabinet completely in melamine



Elemento destro a forma di goccia con funzione riunione.
Drop-shaped right element with meeting function.

Code	Dimension cm	Dimension inches	Price €
ZZSQUARDSK4013	100x90x72h	39 ¹ / ₂ x 35 ¹ / ₂ x 28 ¹ / ₂ h	547,00

Piano in melaminico. Base verniciata alluminio (RAL 9006).
Top in melamine coated panel. Base epoxy powder coated in matt aluminum (RAL 9006).



Elemento sinistro a forma di goccia con funzione riunione.
Drop-shaped left element with meeting function.

Code	Dimension cm	Dimension inches	Price €
ZZSQUARDSK4012	100x90x72h	39 ¹ / ₂ x 35 ¹ / ₂ x 28 ¹ / ₂ h	547,00

Piano in melaminico. Base verniciata alluminio (RAL 9006).
Top in melamine coated panel. Base epoxy powder coated in matt aluminum (RAL 9006).



Elemento di raccordo a 180°.
180° connection element.

Code	Dimension cm	Dimension inches	Price €
ZZSQUARDSK4014	120x40x72h	47 ¹ / ₄ x 15 ¹ / ₄ x 28 ¹ / ₂ h	381,00
ZZSQUARDSK4015	160x50x72h	63" x 19 ¹ / ₂ x 28 ¹ / ₂ h	406,00

Piano in melaminico. Base verniciata alluminio (RAL 9006).
Top in melamine coated panel. Base epoxy powder coated in matt aluminum (RAL 9006).



Pannello di cortesia in acciaio per scrivania.
Metal modesty panel for desk.

Code	Dimension cm	Dimension inches	Price €
ZZSQUARACCD400	126	49 ¹ / ₂	182,00
Per scrivania an 140 - For desk 55 ¹ / ₂			
ZZSQUARACCD401	146	57 ¹ / ₂	198,00
Per scrivania an 160 - For desk 63"			
ZZSQUARACCD402	166	65 ¹ / ₂	217,00
Per scrivania an 180 - For desk 70 ¹ / ₂			

In acciaio verniciato alluminio (RAL 9006).
In epoxy powder coated metal in matt aluminum (RAL 9006).

SQUARE - Scrivanie e allunghi - Desks and extensions



Schermo frontale in melaminico per scrivania. Completo di 2 staffe per il fissaggio.
Melamine front screen panel for desk. Complete with 2 fixing brackets.

Code	Dimension cm	Dimension inches	Price €
ZZSQUARACCD403	140x55x1,9	55 ¹ / ₂ x 21 ¹ / ₂ x 3/4	270,00
Per scrivania an 140 - For desk 55 ¹ / ₂			
ZZSQUARACCD404	160x55x1,9	63" x 21 ¹ / ₂ x 3/4	281,00
Per scrivania an 160 - For desk 63"			
ZZSQUARACCD405	180x55x1,9	70 ¹ / ₂ x 21 ¹ / ₂ x 3/4	291,00
Per scrivania an 180 - For desk 70 ¹ / ₂			

Piano in melaminico. Staffe verniciate alluminio (RAL 9006).
Top in melamine coated panel. Brackets epoxy powder coated in matt aluminum (RAL 9006).

SQUARE - Tavoli riunione - Meeting tables



Tavolo riunione quadrato in melaminico.
Square meeting table in melamine.

Code	Dimension cm	Dimension inches	Price €
ZZSQUARMTB4020	150x150x72h	59" x 59" x 28 ¹ / ₂ h	1268,00

Piano e base in melaminico.
Top and base in melamine coated panel.



Tavolo riunione rettangolare in melaminico.
Rectangular meeting table in melamine.

Code	Dimension cm	Dimension inches	Price €
ZZSQUARMTB4021	210x105x71h	82 ¹ / ₂ x 41 ¹ / ₂ x 28 ¹ / ₂ h	1383,00

Piano e base in melaminico.
Top and base in melamine coated panel.

SQUARE - Cassettiera su ruote - Pedestal on casters



Cassettiera su ruote con 3 cassetti dotati di serratura e vaschetta portacancelleria.
Chest of drawers on casters with 3 drawers with lock and stationery tray.

Code	Dimension cm	Dimension inches	Price €
ZZSQUARSPD4000	42x53x52h	16 ¹ / ₂ x 20 ¹ / ₂ x 20 ¹ / ₂ h	661,00

Struttura in metallo con top e frontali dei cassetti rivestiti con pannelli di melaminico. Fianchi e retro in metallo verniciato alluminio (RAL 9006).
Metal structure with top and drawers front covered with melamine panels. Sides and back panel in epoxy powder coated in aluminum (RAL 9006).

PLUS



La struttura portante delle scrivanie è costituita da una trave sottopiano in acciaio che funge anche da canalina passacavi e che è fissata alle estremità alle due gambe in lamiera scatola che appoggia su due piedi in ghisa. Tutte le parti metalliche sono verniciate a polveri epossidiche in colore grigio antracite goffrato. Sono disponibili sia scrivanie rettangolari che scrivanie angolari e per ognuna di esse è disponibile anche l'allungo laterale. I piani delle scrivanie sono in melaminico spessore 25 mm in diverse finiture. Sono disponibili pannelli di cortesia in melaminico e in acciaio e schermi frontali divisorii in melaminico.

I tavoli riunioni tondi o a botte hanno lo stesso basamento.

La cassetiera su ruote a 3 cassetti ha una struttura in lamiera verniciata a polveri epossidiche in colore grigio antracite goffrato con top, retro, fianchi, e frontali dei cassetti in melaminico. E' dotata di serratura e di maniglie in nickel satinato.



The supporting structure of the desks consists of a steel beam fixed under the top which also acts as a cable tray and which is fixed at the ends to the two boxed sheet metal legs which rests on two cast iron feet. All metal parts are epoxy powder coated in textured anthracite gray color. Both rectangular desks and corner desks are available and the side extension is also available for each of them. The desk tops are in 25 mm thick melamine in different finishes. Modesty panels are available in melamine and steel and front dividing screens in melamine.

The round or barrel shaped meeting tables have the same base.

The pedestal unit on wheels with 3 drawers has a sheet metal structure painted with epoxy powders in grey anthracite color with melamine top, back, side and drawer fronts. It is equipped with a lock and satin nickel handles.

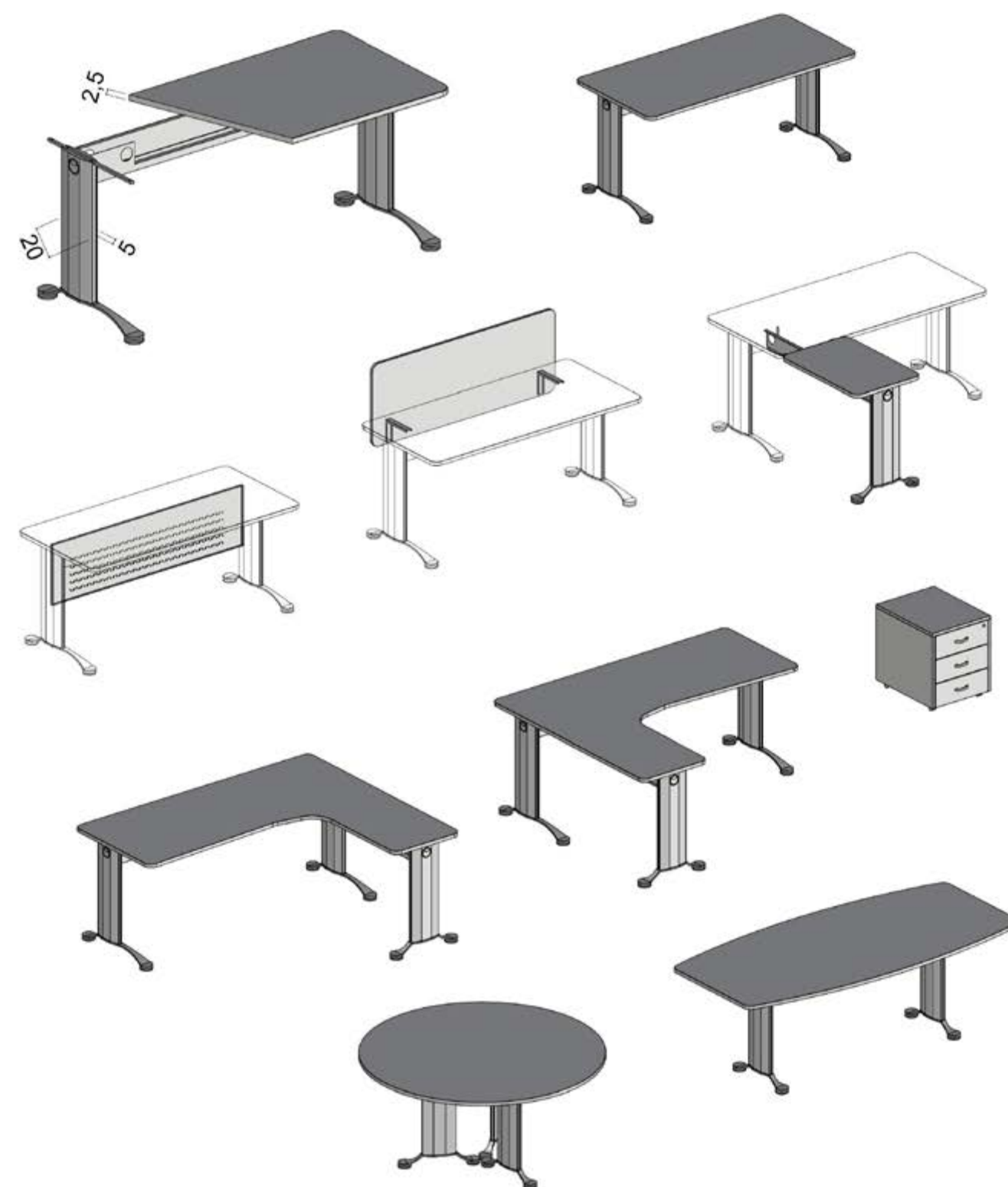

Piani scrivanie ed elementi in melaminico - Desk tops and melamine elements

		
Lino FA41	Noce Chiaro LM01	Rovere Grigio LG18
		
Rovere Bianco LK84	Noce Canaletto LN83	Rovere Spessart LM76
		
Rovere Magister LK97	Ash S001	
		
Bianco B007	Grigio U110	Nero U129
		
Avorio U100	Grafite UB08	

Parti metalliche verniciate a polveri epossidiche - Metal parts epoxy powder coated

Grigio antracite goffrato Textured anthracite grey

PLUS - Scrivanie e allunghi - Desks and extensions

Scrivanie singole in melaminico.
Single desks in melamine.



Code	Dimension cm	Dimension inches	Price €
ZZPLUSDSK5000	140x75x73h	55 ¹ / ₂ x 29 ¹ / ₂ x 28 ³ / ₄ h	975,00
ZZPLUSDSK5001	160x75x73h	63" x 29 ¹ / ₂ x 28 ³ / ₄ h	994,00
ZZPLUSDSK5002	180x75x73h	70 ¹ / ₂ x 29 ¹ / ₂ x 28 ³ / ₄ h	1069,00

Piano in melaminico. Base verniciata grigio antracite con finitura goffrata.
Top in melamine coated panel. Base epoxy powder coated in textured anthracite grey.

Scrivanie angolari destre.
Right corner desks.



Code	Dimension cm	Dimension inches	Price €
ZZPLUSDSK5004	160x150x73h	63" x 59" x 28 ³ / ₄ h	1509,00
ZZPLUSDSK5006	180x150x73h	70 ¹ / ₂ x 59" x 28 ³ / ₄ h	1595,00

Piano in melaminico. Base verniciata grigio antracite con finitura goffrata.
Top in melamine coated panel. Base epoxy powder coated in textured anthracite grey.

Scrivanie angolari sinistre.
Left corner desks.



Code	Dimension cm	Dimension inches	Price €
ZZPLUSDSK5005	160x150x73h	63" x 59" x 28 ³ / ₄ h	1509,00
ZZPLUSDSK5007	180x150x73h	70 ¹ / ₂ x 59" x 28 ³ / ₄ h	1595,00

Piano in melaminico. Base verniciata grigio antracite con finitura goffrata.
Top in melamine coated panel. Base epoxy powder coated in textured anthracite grey.

Allungo.
Extension.



Code	Dimension cm	Dimension inches	Price €
ZZPLUSDSK5003	75x50x73h	29 ¹ / ₂ x 19 ³ / ₄ x 28 ³ / ₄ h	636,00

Piano in melaminico. Base verniciata grigio antracite con finitura goffrata.
Top in melamine coated panel. Base epoxy powder coated in textured anthracite grey.

Pannello di cortesia in acciaio per scrivania.
Metal modesty panel for desk.



Code	Dimension cm	Dimension inches	Price €
ZZPLUSACCD500	127	50	160,00
Per scrivania an 140 - For desk 55 ¹ / ₂ "			
ZZPLUSACCD501	147	57 ¹ / ₂ "	172,00
Per scrivania an 160 - For desk 63"			
ZZPLUSACCD502	167	65 ¹ / ₂ "	180,00
Per scrivania an 180 - For desk 70 ¹ / ₂ "			

Pannello in acciaio verniciato grigio antracite con finitura goffrata.
Textured anthracite grey epoxy powder coated steel panel.

PLUS - Scrivanie e allunghi - Desks and extensions



Schermo frontale in melaminico per scrivania. Completo di 2 staffe per il fissaggio.
Melamine front screen panel for desk. Complete with 2 fixing brackets.

Code	Dimension cm	Dimension inches	Price €
ZZPLUSSACCD503	120x55x1,9	47 ¹ / ₄ x 21 ⁵ / ₈ x 3/4	270,00
Per scrivania cm 140 - For desk 55 ¹ / ₂ "			
ZZPLUSSACCD504	140x55x1,9	55 ¹ / ₈ x 21 ⁵ / ₈ x 3/4	280,00
Per scrivania cm 160 - For desk 63"			
ZZPLUSSACCD505	160x55x1,9	63" x 21 ⁵ / ₈ x 3/4	297,00
Per scrivania cm 180 - For desk 70 ¹ / ₂ "			

Pannello in melaminico. Staffe verniciate grigio antracite con finitura goffrata.
Melamine coated panel. Brackets epoxy powder coated in textured anthracite grey.

PLUS - Tavoli riunione - Meeting tables



Tavolo riunione rotondo in melaminico.
Round meeting table in melamine.

Code	Dimension cm	Dimension inches	Price €
ZZPLUSSMTB5020	150x150x73h	59" x 59" x 28 ¹ / ₄ h	1248,00

Fiano in melaminico. Base verniciata grigio antracite con finitura goffrata.
Top in melamine coated panel. Base epoxy powder coated in textured anthracite grey.



Tavolo riunione a forma di botte in melaminico.
Barrel-shaped meeting table in melamine.

Code	Dimension cm	Dimension inches	Price €
ZZPLUSSMTB5021	210x100x73h	82 ¹ / ₈ x 39 ¹ / ₈ x 28 ¹ / ₄ h	1034,00

Fiano in melaminico. Base verniciata grigio antracite con finitura goffrata.
Top in melamine coated panel. Base epoxy powder coated in textured anthracite grey.

PLUS - Cassettiera su ruote - Pedestal on casters



Cassettiera su ruote in melaminico con 3 cassetti dotati di serratura e vaschetta portacancelleria.
Chest of drawers on casters in melamine with 3 drawers with lock and stationery tray.

Code	Dimension cm	Dimension inches	Price €
ZZPLUSSSPD5000	45x56x54h	17 ¹ / ₄ x 22" x 21 ¹ / ₄ h	803,00

Struttura in metallo con top, retro, fianchi e frontali dei cassetti rivestiti con pannelli di melaminico.
Metal structure with top, back, sides and drawers fronts covered with melamine panels.

BASE



Questo modello è caratterizzato dall'essere costruito con pannelli di melaminico con spessore 25 mm. Le scrivanie sono sempre costituite da un piano, due gambe ed un pannello di cortesia tutti realizzati con pannelli di melaminico assemblati fra loro tramite dei distanziali verniciati bianchi o neri. Sono disponibili allunghi diritti o angolari e pannelli frontali divisorii sempre in melaminico. I tavoli riunione sono quadrati o rettangolari ed hanno come base due pannelli di melaminico incrociati fra loro.

La cassetiera su ruote a 3 cassetti ha una struttura in lamiera verniciata a polveri epossidiche in colore bianco o nero opaco con top e frontali dei cassetti in melaminico. E' dotata di serratura e di maniglie verniciate alluminio opaco.

This model is characterized by being built with 25 mm thick melamine panels. The desks always consist of one top, two legs and a courtesy panel, all made with melamine panels assembled together thanks to metal spacers painted in white or black. Straight or angular extensions and modesty panels are also available always in melamine.

The meeting tables are square or rectangular and have two crossed melamine panels as a base.

The pedestal unit on wheels with 3 drawers has a sheet metal structure painted with epoxy powders in matt white or black color with melamine top and drawer fronts. It is equipped with a lock and with matt aluminum painted handles.



BASE - Finiture disponibili - Available finishes

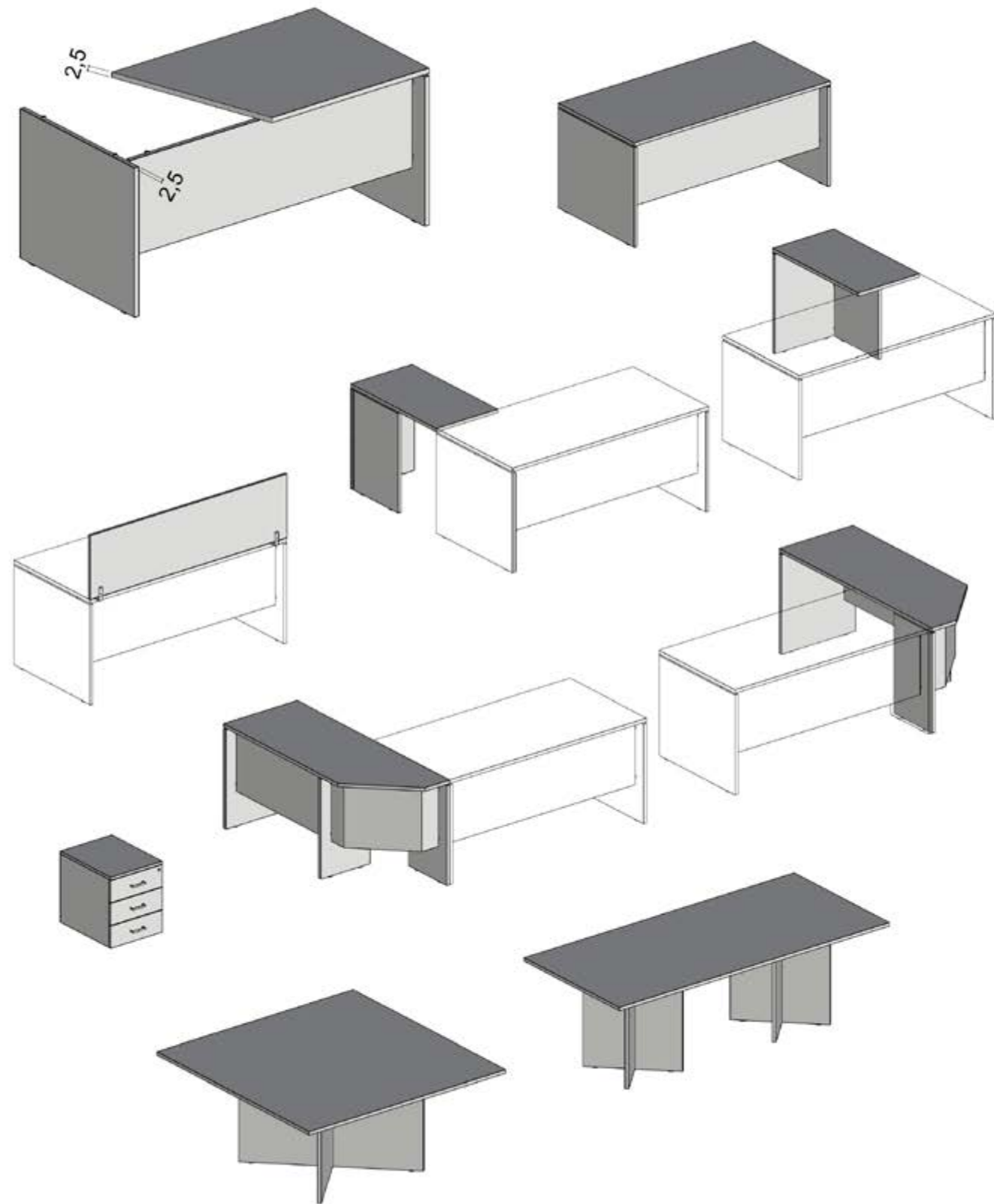

Piani scrivanie ed elementi in melaminico - Desk tops and melamine elements



Lino FA41



Noce Chiaro LM01



Rovere Grigio LG18



Rovere Bianco LK84



Noce Canaletto LN83



Rovere Spessart LM76



Rovere Magister LK97



Ash S001



Bianco B007



Grigio U110

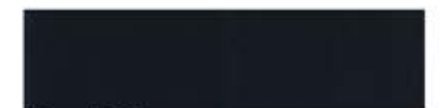

Nero U129



Avorio U100



Grafite UB08

BASE - Scrivanie e allunghi - Desks and extensions



Scrivanie singole.
Single desks.

Code	Dimension cm	Dimension inches	Price €
ZZBASEEDSK8000	140x80x74h	55 ¹ / ₂ x 31 ¹ / ₂ x 29 ¹ / ₂ h	677,00
ZZBASEEDSK8001	160x80x74h	63" x 31 ¹ / ₂ x 29 ¹ / ₂ h	697,00
ZZBASEEDSK8002	180x80x74h	70 ¹ / ₂ x 31 ¹ / ₂ x 29 ¹ / ₂ h	717,00

Pannelli in melaminico. Distanziali verniciati bianchi o neri.
Melamine coated panels. Spacers white or black painted.



Allungo lineare destro.
Right straight extension.

Code	Dimension cm	Dimension inches	Price €
ZZBASEEDSK8003	90x50x74h	35 ¹ / ₂ x 19 ³ / ₈ x 29 ¹ / ₂ h	457,00

Pannelli in melaminico. Distanziali verniciati bianchi o neri.
Melamine coated panels. Spacers white or black painted.

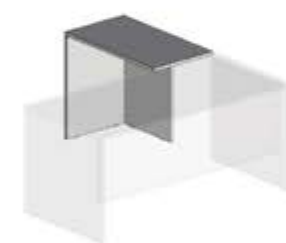

Allungo lineare sinistro.
Left straight extension.

Code	Dimension cm	Dimension inches	Price €
ZZBASEEDSK8004	90x50x74h	35 ¹ / ₂ x 19 ³ / ₈ x 29 ¹ / ₂ h	457,00

Pannelli in melaminico. Distanziali verniciati bianchi o neri.
Melamine coated panels. Spacers white or black painted.



Allungo angolare destro.
Right corner extension.

Code	Dimension cm	Dimension inches	Price €
ZZBASEEDSK8005	160x60x74h	63" x 23 ³ / ₈ x 29 ¹ / ₂ h	864,00

Pannelli in melaminico. Distanziali verniciati bianchi o neri.
Melamine coated panels. Spacers white or black painted.

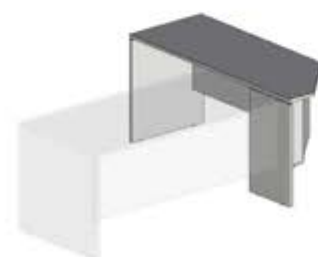

Allungo angolare sinistro.
Left corner extension.

Code	Dimension cm	Dimension inches	Price €
ZZBASEEDSK8006	160x60x74h	63" x 23 ³ / ₈ x 29 ¹ / ₂ h	864,00

Pannelli in melaminico. Distanziali verniciati bianchi o neri.
Melamine coated panels. Spacers white or black painted.

BASE - Scrivanie e allunghi - Desks and extensions



Schermo frontale in melaminico per scrivania. Completo di 2 staffe per il fissaggio.
Melamine front screen panel for desk. Complete with 2 fixing brackets.

Code	Dimension cm	Dimension inches	Price €
ZZBASEEACCD800	140x45x2	55 ¹ / ₂ x 17 ³ / ₈ x 3/8"	298,00
Per scrivania an 140 - For desk 55"			
ZZBASEEACCD801	160x45x2	63" x 17 ³ / ₈ x 3/8"	306,00
Per scrivania an 160 - For desk 63"			
ZZBASEEACCD802	180x45x2	70 ¹ / ₂ x 17 ³ / ₈ x 3/8"	316,00
Per scrivania an 180 - For desk 70"			

Pannello in melaminico. Staffe verniciate in colore bianco opaco o nero opaco.
Melamine coated panel. Brackets painted in color white matt or black matt.

BASE - Tavoli riunione - Meeting tables

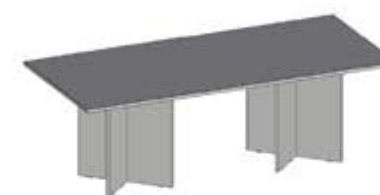

Tavolo riunione rettangolare.
Rectangular meeting table.

Code	Dimension cm	Dimension inches	Price €
ZZBASEEMTB8020	220x100x74h	86 ¹ / ₂ x 39 ³ / ₈ x 29 ¹ / ₂ h	840,00

Pannelli in melaminico. Distanziali verniciati bianchi o neri.
Melamine coated panels. Spacers white or black painted.



Tavolo riunione quadrato.
Square meeting table.

Code	Dimension cm	Dimension inches	Price €
ZZBASEEMTB8021	160x160x74h	63" x 63" x 29 ¹ / ₂ h	788,00

Pannelli in melaminico. Distanziali verniciati bianchi o neri.
Melamine coated panels. Spacers white or black painted.

BASE - Cassettiera su ruote - Pedestal on casters



Cassettiera su ruote con 3 cassetti dotati di serratura e vaschetta portacancelleria.
Chest of drawers on casters with 3 drawers with lock and stationery tray.

Code	Dimension cm	Dimension inches	Price €
ZZBASEESPD8000	42x53x52h	16 ¹ / ₂ x 20 ¹ / ₂ x 20 ¹ / ₂ h	643,00

Struttura in metallo bianco o nero opaco. Top e frontale dei cassetti in melaminico.
Metal structure epoxy powder coated in matt white or black. Top and drawers front in melamine coated panels.

COMPLEMENTI per scrivanie - FITTINGS for desks

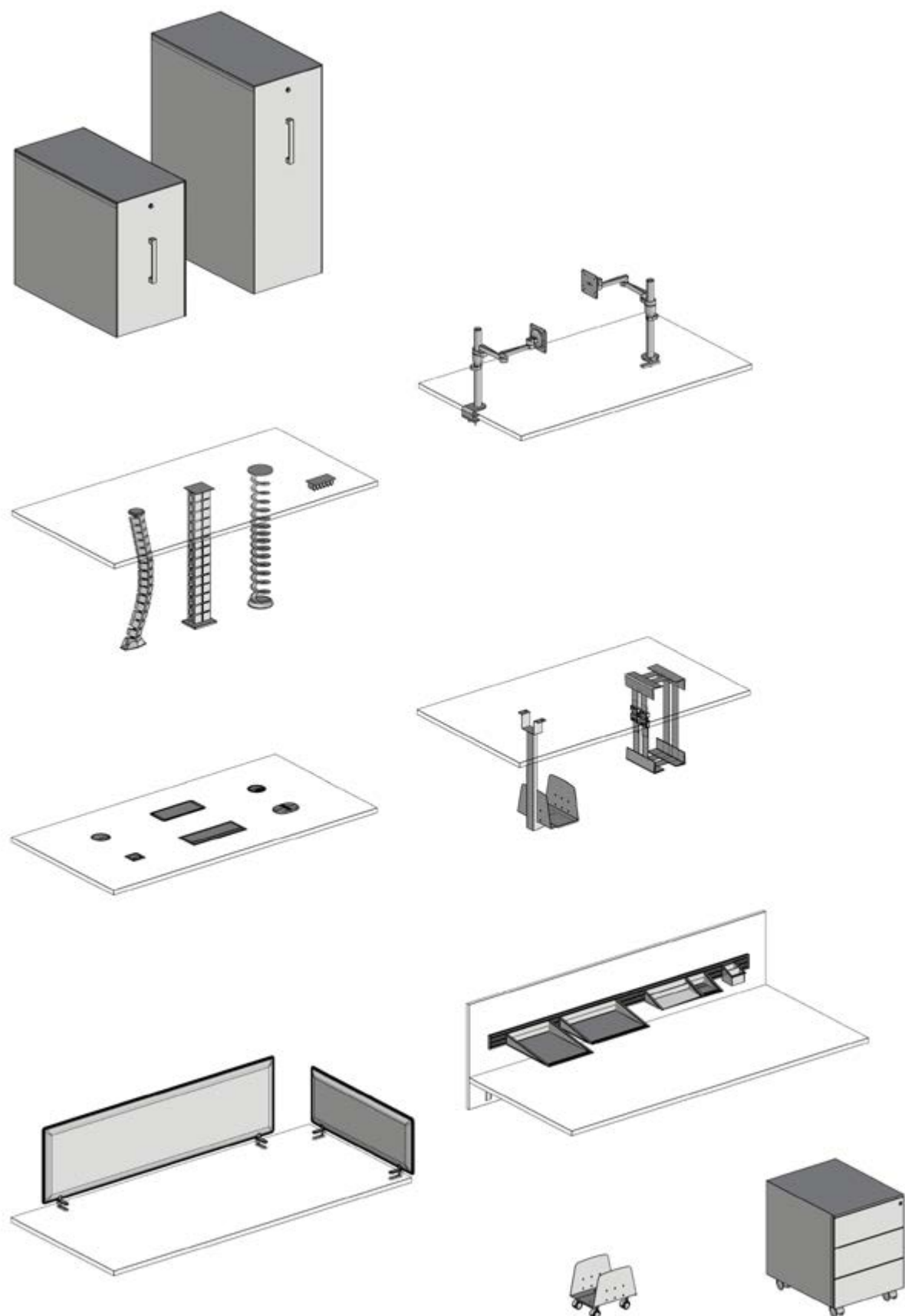

Cassettiera su ruote - Pedestal on casters

Cassettiera su ruote in metallo.
Metal sheet pedestal on casters.



Code	Dimension cm	Dimension inches	Price €
ZZCOMELFTP100	42x53x55h	16 ¹ / ₂ x 20 ¹ / ₈ x 21 ¹ / ₂ h	378,00
ZZCOMELFTP101	32x53x55h	12 ¹ / ₈ x 20 ¹ / ₈ x 21 ¹ / ₂ h	378,00

Verniciata in colore bianco opaco, nero opaco, grigio alluminio opaco o grigio alluminio goffrato.
Epoxy powder coated in color matt white, matt black, matt aluminum grey or textured aluminum grey.

Classificatore verticale in metallo verniciato bianco opaco con serratura. Dotato di telaio estraibile con due ripiani predisposti per cartelle sospese e una vaschetta portapenne.
Vertical file cabinet in matt white painted metal with lock. Equipped with extractable frame with two shelves suitable for hanging folders and pen tray.



Code	Dimension cm	Dimension inches	Price €
ZZCOMELFTP102	42x80x72h	16 ¹ / ₂ x 31 ¹ / ₂ x 28 ¹ / ₂ h	1396,00
ZZCOMELFTP104	42x80x110h	16 ¹ / ₂ x 31 ¹ / ₂ x 43 ¹ / ₄ h	2110,00

Classificatore verticale in metallo verniciato bianco opaco con frontale in melaminico e serratura. Dotato di telaio estraibile con due ripiani predisposti per cartelle sospese e una vaschetta portapenne.
Vertical file cabinet in matt white painted metal with front in melamine with lock. Equipped with extractable frame with two shelves suitable for hanging folders and pen tray.

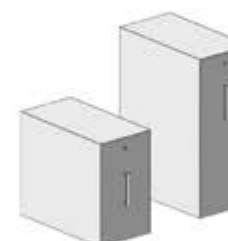

Code	Dimension cm	Dimension inches	Price €
ZZCOMELFTP103	42x80x72h	16 ¹ / ₂ x 31 ¹ / ₂ x 28 ¹ / ₂ h	1500,00
ZZCOMELFTP105	42x80x110h	16 ¹ / ₂ x 31 ¹ / ₂ x 43 ¹ / ₄ h	2153,00

Schermo frontale attrezzato per scrivanie singole - Equipped front screen for single desks

Barre orizzontale in alluminio da fissare a schermo frontale per alloggiamento vaschette in policarbonato.
Horizontal aluminum bar to be fixed to a front screen for housing polycarbonate trays.



Code	Price €
ZZCOMELFTTD100	187,00

Vaschetta portacancelleria in policarbonato trasparente.
Transparent polycarbonate stationery tray.



Code	Dimension cm	Dimension inches	Price €
ZZCOMELFTTD107	27x35x6h	10 ¹ / ₈ x 13 ¹ / ₈ x 2 ¹ / ₂ h	74,00

Vaschetta portacancelleria in policarbonato trasparente.
Transparent polycarbonate stationery tray.



Code	Dimension cm	Dimension inches	Price €
ZZCOMELFTTD108	35x27x6h	13 ¹ / ₈ x 10 ¹ / ₈ x 2 ¹ / ₂ h	78,00

Schermo frontale attrezzato per scrivanie singole - Equipped front screen for single desks



Vaschetta portaoggetti in policarbonato trasparente.
Storage tray in transparent polycarbonate.

Code	Dimension cm	Dimension inches	Price €
ZZCOMELFTTD109	38x15x6h	15" x 5 ⁷ / ₈ " x 2 ³ / ₈ "h	94,00



Portamatite in policarbonato trasparente.
Pencil holder in transparent polycarbonate.

Code	Dimension cm	Dimension inches	Price €
ZZCOMELFTTD110	9,5x8,5x9h	3 ³ / ₄ " x 3 ³ / ₈ " x 3 ¹ / ₂ "h	64,00

Gestione dei cavi - Cable management



Tappo passacavi Basic rotondo in PVC bianco, grigio chiaro, grigio antracite, nero o effetto cromo.
Round PVC Basic cable grommet in color white, light grey, charcoal grey, black or chromed effect.

Code	Diametro cm	Diameter inches	Price €
ZZCOMELFTTD111	6	2 ³ / ₈ "	48,00
ZZCOMELFTTD112	8	3 ¹ / ₈ "	48,00



Tappo passacavi Basic quadrato in PVC grigio chiaro.
Square PVC Basic cable grommet in light grey color.

Code	Diametro cm	Diameter inches	Price €
ZZCOMELFTTD113	6	2 ³ / ₈ "	45,00



Tappo passacavi Executive Oval in zama con finitura cromata e spazzola in nylon nero.
Executive Oval cable grommet in zamak with chrome finish and black nylon brush.

Code	Diametro cm	Diameter inches	Price €
ZZCOMELFTTD150	8	3 ¹ / ₈ "	92,00
Per piani in melaminico - For melamine tops			
ZZCOMELFTTD151	8	3 ¹ / ₈ "	280,00
Per piani in vetro - For glass tops			



Tappo passacavi Executive Round in zama con finitura bianca, nera o cromo lucido e spazzola in polipropilene nero.
Executive Round cable grommet in zamak with white, black or polished chrome finish and black polypropylene brush.

Code	Diametro cm	Diameter inches	Price €
ZZCOMELFTTD152	8	3 ¹ / ₈ "	76,00
Per piani in melaminico - For melamine tops			
ZZCOMELFTTD153	8	3 ¹ / ₈ "	263,00
Per piani in vetro - For glass tops			

Gestione dei cavi - Cable management



Vaschetta passacavi Exit Edge in alluminio estruso con finitura bianca, nero opaco o alluminio anodizzato. Spazzola in polipropilene grigio.
Exit Edge cable tray in extruded aluminum with white, matt black or anodized aluminum finish. Gray polypropylene brush.

Code	Dimension cm	Dimension inches	Price €
ZZCOMELFTTD115	24x12x2,5	9 ¹ / ₂ " x 4 ¹ / ₄ " x 1"h	129,00
Per piani in melaminico - For melamine tops			
ZZCOMELFTTD145	24x12x2,5	9 ¹ / ₂ " x 4 ¹ / ₄ " x 1"h	363,00
Per piani in vetro - For glass tops			
ZZCOMELFTTD116	32x12x2,5	12 ⁵ / ₈ " x 4 ¹ / ₄ " x 1"h	138,00
Per piani in melaminico - For melamine tops			
ZZCOMELFTTD146	32x12x2,5	12 ⁵ / ₈ " x 4 ¹ / ₄ " x 1"h	372,00
Per piani in vetro - For glass tops			
ZZCOMELFTTD117	45x12x2,5	17 ³ / ₄ " x 4 ¹ / ₄ " x 1"h	150,00
Per piani in melaminico - For melamine tops			
ZZCOMELFTTD147	45x12x2,5	17 ³ / ₄ " x 4 ¹ / ₄ " x 1"h	384,00
Per piani in vetro - For glass tops			



Vaschetta passacavi Light in plastica con finitura bianca, nera o alluminio.
Light cable tray in plastic with white, black or aluminum finish.

Code	Dimension cm	Dimension inches	Price €
ZZCOMELFTTD114	26x12	10 ¹ / ₄ " x 4 ¹ / ₄ "	72,00
Per piani in melaminico - For melamine tops			
ZZCOMELFTTD144	26x12	10 ¹ / ₄ " x 4 ¹ / ₄ "	306,00
Per piani in vetro - For glass tops			

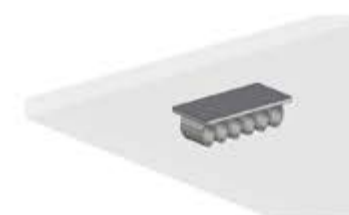

Supporto con sei anelli in polistirene per il passaggio cavi. Kit composto da 4 pezzi. Disponibili in colore alluminio.
Support with six polystyrene rings for cable passage. Kit consisting of 4 pieces. Available in aluminum color.

Code	Price €
ZZCOMELFTTD118	58,00



Canalina salita cavi Brick in ABS colore bianco, trasparente o alluminio.
Brick cable plastic duct in color white, transparent or aluminum.

Code	Price €
ZZCOMELFTTD120	93,00

Gestione dei cavi - Cable management



Canalina salita cavi Vertebra in plastica con colore bianco, grafite, alluminio o cromo.
Vertebra cable duct riser in plastic with white, graphite, aluminum or chrome color.

Code	Price €
ZZCOMELFTTD121	85,00
Finitura bianco grafite o alluminio - White, graphite or aluminum finish	
ZZCOMELFTTD148	110,00
Finitura cromata - Chrome finish	



Canalina salita cavi Elix con piede in zama effetto cromato e spazzola colore grigio o nero.
Elix cable duct riser with chromed effect zamak foot and gray or black brush.

Code	Price €
ZZCOMELFTTD122	188,00

Gestione CPU e monitor - CPU and monitor management



Porta CPU in lamiera da fissare sotto al piano. Disponibile verniciato a polveri epossidiche in colore bianco opaco, nero opaco, antracite opaco, alluminio opaco e alluminio goffrato.
CPU holder in sheet metal to be fixed under the top. Available painted with epoxy powders in matt white, matt black, matt anthracite, matt aluminum and textured aluminum.

Code	Price €
ZZCOMELFTTD124	176,00



Porta CPU in lamiera su ruote. Disponibile verniciato a polveri epossidiche in colore bianco opaco, nero opaco, antracite opaco, alluminio opaco e alluminio goffrato.
CPU holder in sheet metal on casters. Available painted with epoxy powders in matt white, matt black, matt anthracite, matt aluminum and textured aluminum.

Code	Price €
ZZCOMELFTTD126	137,00



Porta CPU a cinghie.
Belted CPU holder.

Code	Price €
ZZCOMELFTTD125	156,00



Porta monitor Kinetik in finitura alluminio.
Kinetik monitor holder in aluminum finish.

Code	Price €
ZZCOMELFTTD127	319,00

Schermi frontali in tessuto fonoassorbente - Front screens in sound-absorbing fabric



Schermo frontale in pannello rivestito in tessuto fonoassorbente. Completo di 2 staffe per il fissaggio.
Front screen panel covered in sound absorbing fabric. Complete with 2 fixing brackets.

Front screen panel covered in sound absorbing fabric. Complete with 2 fixing brackets.

Code	Dimension cm	Dimension inches	Price €
ZZCOMELFTTD130	80x30h	31"½ x 11"¾h	359,00
ZZCOMELFTTD131	120x40h	47"¼ x 15"¾h	468,00
ZZCOMELFTTD132	140x40h	55"¼ x 15"¾h	519,00
ZZCOMELFTTD133	160x40h	63" x 15"¾h	562,00

Disponibili nei tessuti sotto indicati.
Available in the fabrics indicated below.

Tessuti disponibili per i pannelli fonoassorbenti - Available fabrics for sound absorbing panels



Rosso 236
Red 236



Verde bosco 496
Forest green 496



Verde acido 426
Acid green 426



Blu 332
Blue 332



Azzurro 377
Light blue 377



Avorio 532
Ivory 532



Grigio 629
Grey 629



Antracite 607
Anthracite 607

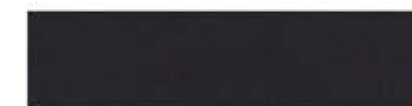

Nero 651
Black 651

**SEDUTE
SEATING**

Meccanismi disponibili - Available mechanisms



SYNCRON SELF CON TRASLATORE SEDILE – SYNCRON SELF WITH SLIDING SEAT

Meccanismo Synchron autotarante, con ricerca automatica della posizione utile di blocco, angolo apertura schienale 20°, angolo inclinazione sedile 6°, 5 posizioni di bloccaggio e sistema antishock. Sedile regolabile in profondità 60 mm.
Synchron mechanism, with automatic search for the useful locking position, backrest tilt angle 20°, seat tilt angle 6°, 5 locking positions and backrest return prevention safety function. Sliding seat 60 mm.

SYNCRON TOP CON TRASLATORE SEDILE – SYNCRON TOP WITH SLIDING SEAT

Meccanismo Synchron con angolo apertura schienale 21°, angolo inclinazione sedile 12°, regolazione della tensione con manopola laterale da 50 kg a 120 kg. Dispositivo multiblock 4 posizioni e sistema antishock. Sedile regolabile in profondità 65 mm.
Synchron mechanism, with backrest tilt angle 21°, seat tilt angle 12°, lateral tension adjustment knob from 50 kg to 120 kg. Multiblock system with 4 locking positions and backrest return prevention safety function. Sliding seat 65 mm.

SYNCRON BASIC – SYNCRON BASIC

Meccanismo Synchron con angolo apertura schienale 20°, angolo inclinazione sedile 11°, regolazione della tensione con pomolo centrale da 50 kg a 120 kg. Dispositivo multiblock 5 posizioni e sistema antishock.
Synchron mechanism, with backrest tilt angle 20°, seat tilt angle 11°, central tension adjustment knob from 50 kg to 120 kg. Multiblock system with 5 locking positions and backrest return prevention safety function.

OSCILLANTE LUSO A FULCRO AVANZATO – LUXURY TILTING WITH ADVANCED PIVOT POINT

Meccanismo oscillante Lusso a fulcro avanzato angolo di apertura 16°, regolazione della tensione con manovella laterale da 50 kg a 120 kg. Dispositivo multiblock 4 posizioni e sistema antishock.
Luxury tilting mechanism with advanced pivot point, backrest tilt angle 16°, lateral tension adjustment knob from 50 kg to 120 kg. Multiblock system with 4 locking positions and backrest return prevention safety function.

OSCILLANTE A FULCRO AVANZATO – TILTING WITH ADVANCED PIVOT POINT

Meccanismo oscillante a fulcro avanzato angolo di apertura 16°, regolazione della tensione con pomolo centrale da 50 kg a 120 kg. Dispositivo multiblock 3 posizioni e sistema antishock.
Tilting mechanism with advanced pivot point, backrest tilt angle 16°, central tension adjustment knob from 50 kg to 120 kg. Multiblock system with 3 locking positions and backrest return prevention safety function.

OSCILLANTE ECO – ECO TILTING

Meccanismo oscillante Eco angolo di apertura 16°, regolazione della tensione con pomolo centrale da 50 kg a 120 kg. Dispositivo multiblock 3 posizioni e sistema antishock.
Eco tilting mechanism with backrest tilt angle 16°, central tension adjustment knob from 50 kg to 120 kg. Multiblock system with 3 locking positions and backrest return prevention safety function.

Finiture disponibili per le sedute - Available finishes for seatings

GELSOMINO – Cat. A

Tessuto ignifugo autoestinguente Classe 11M – 100% Poliestere – Peso 400 gr/mq – 80.000 Martindale
Fire retardant fabric italian test Classe 11M – 100% Polyester – Weight 400 gr/mq – 80.000 Martindale

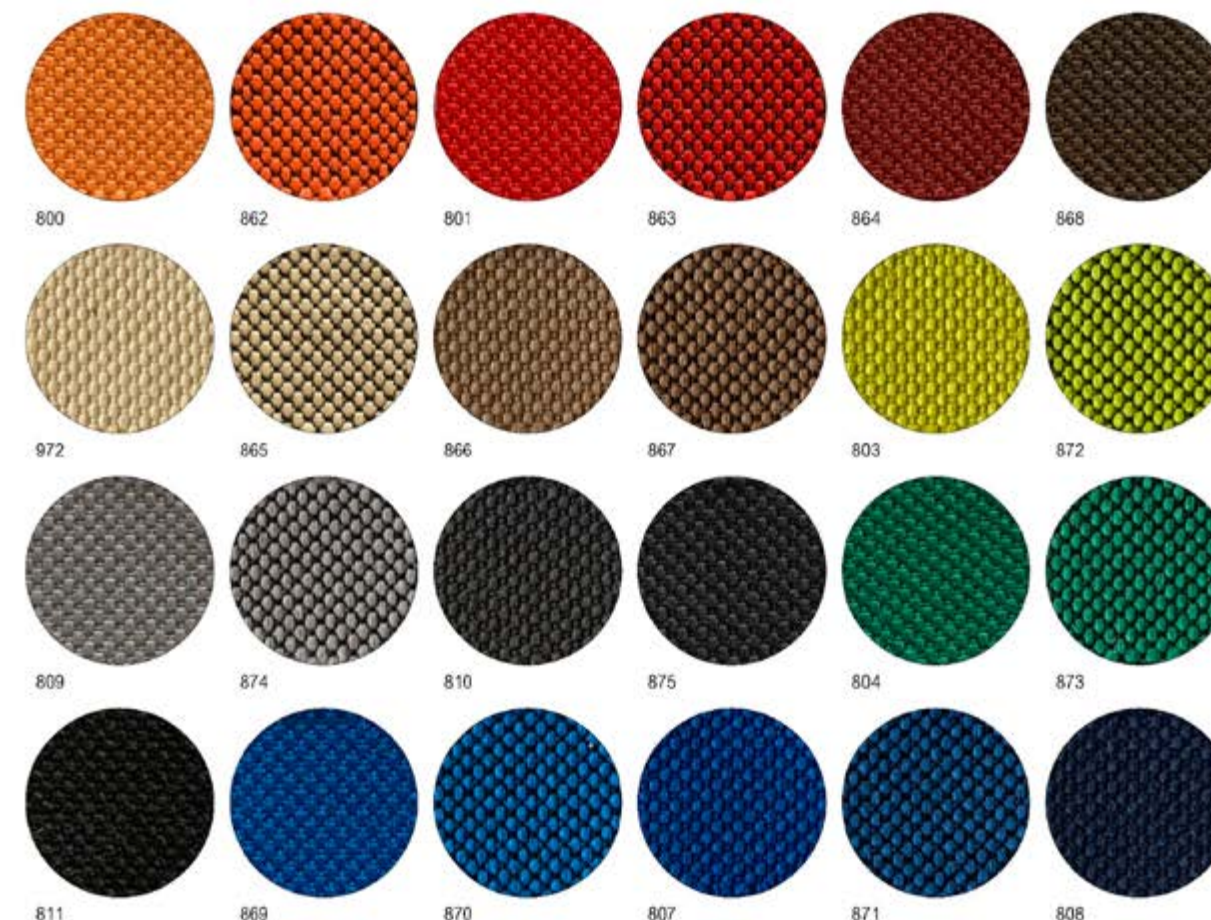

ROSE – Cat. B

Tessuto ignifugo autoestinguente Classe 11M – 100% Poliestere riciclato – Peso 290 gr/mq – 100.000 Martindale
Fire retardant fabric italian test Classe 11M – 100% Recycled polyester – Weight 290 gr/mq – 100.000 Martindale

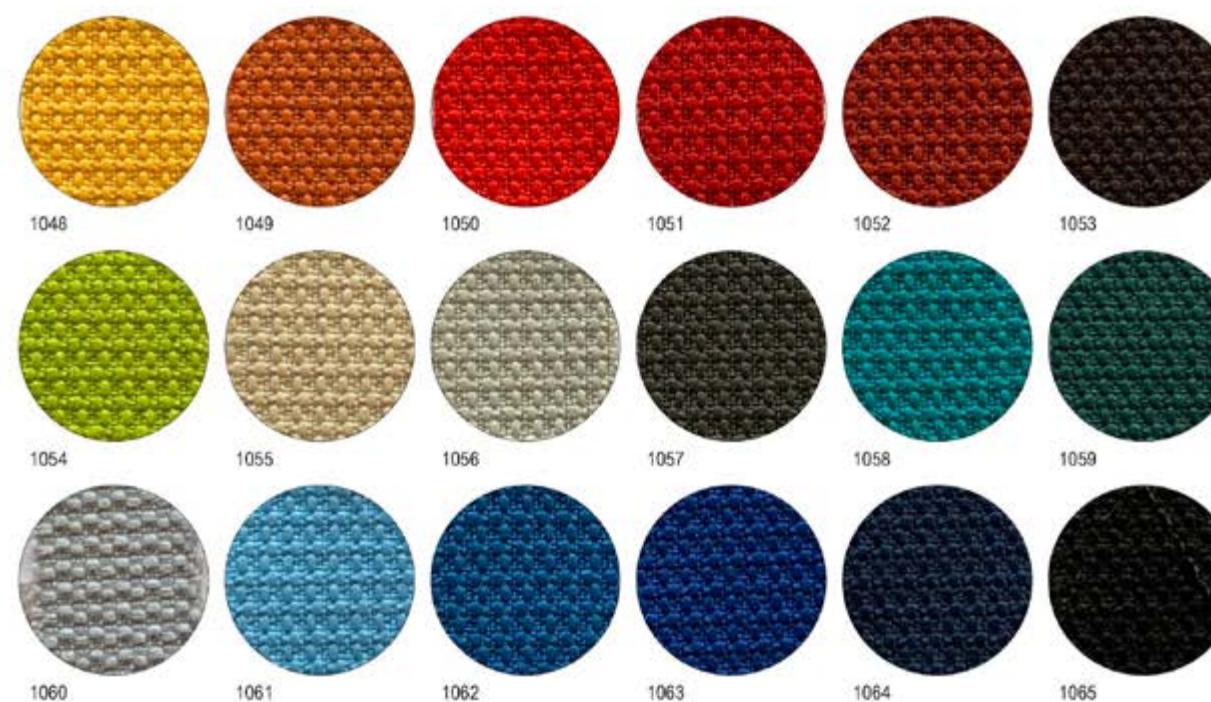

Finiture disponibili per le sedute - Available finishes for seatings

FIORDALISO - Cat. B

Ecopelle ignifuga autoestinguente Classe 11M - 90% PVC plastificato, 10% Poliammide - Peso 700 gr/mq - 80.000 Martindale
 Fire retardant eco-leather italian test Classe 11M - 90% PVC plastic-coated, 10% Polyamid - Weight 700 gr/mq - 80.000 Martindale



ORTENSIA - Cat. D

Tessuto ignifugo autoestinguente Classe 11M - 70% Lana, 30% Lino - Peso 440 gr/mq - 100.000 Martindale
 Fire retardant fabric italian test Classe 11M - 70% Wool, 30% Linen - Weight 440 gr/mq - 100.000 Martindale

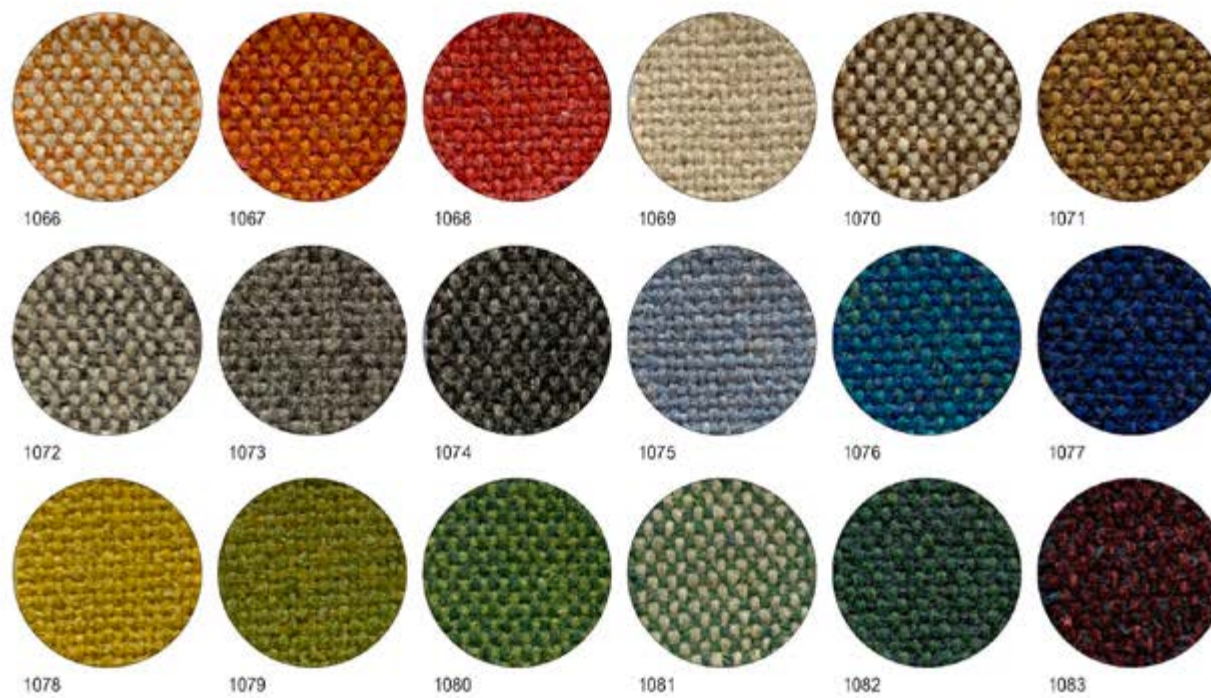

Finiture disponibili per le sedute - Available finishes for seatings

TULIPANO - Cat. B

Tessuto ignifugo autoestinguente Classe 11M - 100% Poliestere riciclato - Peso 350 gr/mq - 100.000 Martindale
 Fire retardant fabric italian test Classe 11M - 100% Recycled polyester - Weight 350 gr/mq - 100.000 Martindale



NARCISO - Cat. D

Tessuto ignifugo autoestinguente Classe 11M - 100% Lana - Peso 550 gr/mq - 60.000 Martindale
 Fire retardant fabric italian test Classe 11M - 100% Wool - Weight 550 gr/mq - 60.000 Martindale



Finiture disponibili per le sedute - Available finishes for seatings

IRIS - Cat. D

Tessuto ignifugo autoestinguente Classe 11M - 100% Poliolefinica - Peso 505 gr/mq - 50.000 Martindale
 Fire retardant fabric italian test Classe 11M - 100% Polyolefin - Weight 505 gr/mq - 50.000 Martindale



GERANIO

Rete ignifuga autoestinguente Classe 11M - 77% Polivinile,
 23% Poliestere - Peso 560 gr/mq
 Fire retardant mesh italian test Classe 11M - 77% Polyvinyl,
 23% Polyester - Weight 560 gr/mq

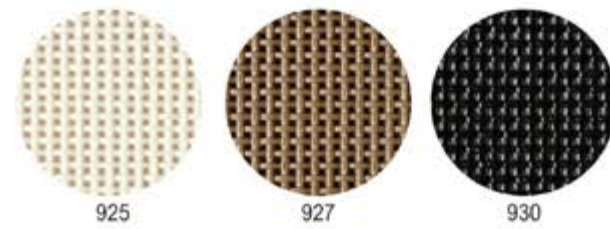

MUGHETTO

Rete ignifuga autoestinguente Classe 11M - 100% Poliestere
 - Peso 540 gr/mq
 Fire retardant mesh italian test Classe 11M - 100% Polyester
 - Weight 540 gr/mq

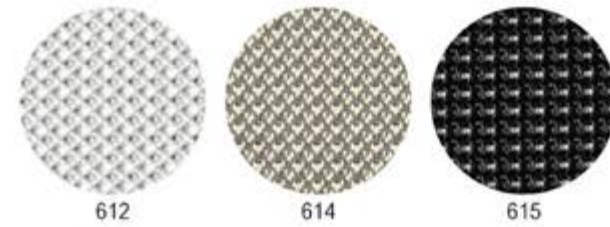

GENZIANA

Rete ignifuga autoestinguente Classe 11M - 100% Poliestere
 - Peso 400 gr/mq
 Fire retardant mesh italian test Classe 11M - 100% Polyester
 - Weight 400 gr/mq

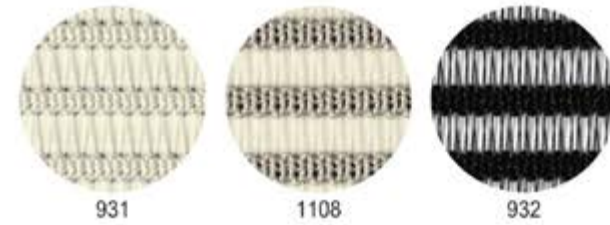

**SEDUTE DIREZIONALI
MANAGERIAL SEATING**



Poltrona direzionale con poggiatesta, schienale imbottito, senza braccioli, meccanismo Synchron Basic, elevazione a gas, base a 5 razze in nylon nero, ruote autofrenanti gommate. Rivestimento fascia laterale dello schienale e della seduta in ecopelle nera e carter dello schienale in polipropilene nero.

Padded executive armchair with headrest, without armrests, Synchron Basic mechanism, gas lift, black nylon 5 stars base, rubber braked castors. Lateral side strips of the backrest and of the seat covered in black eco-leather; backrest cover in black polypropylene.

Dimensioni		Dimensions	
Altezza totale (cm)	117	Total height (inches)	46 1/4
Altezza sedile (cm)	45	Seat height (inches)	17 3/4
Larghezza max. con braccioli (cm)	65	Max width with armrests (inches)	25 3/4
Profondità totale (cm)	58	Total depth (inches)	22 3/4
Peso max. (kg)	17	Weight max. (kg)	17
Volume (m³)	0,20	Volume (m³)	0,20
Tessuto (m²)	1,30	Fabric (yards)	1,43
Pelle (m²)	2,40	Leather (sq. feet)	25,8

Code		Price €
ZYLOGICKD3EYA	Rivestimento in cat. A - Cover in cat. A	809,00
ZYLOGICKD3EYB	Rivestimento in cat. B - Cover in cat. B	844,00
ZYLOGICKD3EYD	Rivestimento in cat. D - Cover in cat. D	945,00

Base in alluminio Lucido Polished aluminum base	130,00
Synchron Self con traslatore sedile Synchron Self with sliding seat	168,00
Braccioli in nylon nero regolabili in altezza Height-adjustable black nylon armrests	91,00
Braccioli in nylon nero fissi a forma triangolare Fixed and triangular shaped black nylon armrests	77,00
Braccioli in nylon nero fissi a forma di T Fixed T shaped black nylon armrests	84,00



Poltrona semi-direzionale con schienale imbottito, senza braccioli, meccanismo Synchron Basic, elevazione a gas, base a 5 razze in nylon nero, ruote autofrenanti gommate. Rivestimento fascia laterale dello schienale e della seduta in ecopelle nera e carter dello schienale in polipropilene nero.

Padded manager armchair without armrests, Synchron Basic mechanism, gas lift, black nylon 5 stars base, rubber braked castors. Lateral side strips of the backrest and of the seat covered in black eco-leather; backrest cover in black polypropylene.

Dimensioni		Dimensions	
Altezza totale (cm)	99	Total height (inches)	39"
Altezza sedile (cm)	45	Seat height (inches)	17 3/4
Larghezza max. con braccioli (cm)	65	Max width with armrests (inches)	25 3/4
Profondità totale (cm)	58	Total depth (inches)	22 3/4
Peso max. (kg)	16	Weight max. (kg)	16
Volume (m³)	0,18	Volume (m³)	0,18
Tessuto (m²)	1,30	Fabric (yards)	1,43
Pelle (m²)	2,40	Leather (sq. feet)	25,8

Code		Price €
ZYLOGICKS3EYA	Rivestimento in cat. A - Cover in cat. A	697,00
ZYLOGICKS3EYB	Rivestimento in cat. B - Cover in cat. B	732,00
ZYLOGICKS3EYD	Rivestimento in cat. D - Cover in cat. D	837,00

Base in alluminio Lucido Polished aluminum base	130,00
Synchron Self con traslatore sedile Synchron Self with sliding seat	168,00
Braccioli in nylon nero regolabili in altezza Height-adjustable black nylon armrests	91,00
Braccioli in nylon nero fissi a forma triangolare Fixed and triangular shaped black nylon armrests	77,00
Braccioli in nylon nero fissi a forma di T Fixed T shaped black nylon armrests	84,00



Poltrona operativa con schienale imbottito, senza braccioli, meccanismo girevole, elevazione a gas, base a 5 razze in nylon nero, ruote autofrenanti gommate. Rivestimento della fascia laterale dello schienale e della seduta in ecopelle nera; carter dello schienale in polipropilene nero.

Padded task armchair without armrests, swivel mechanism, gas lift, black nylon 5 stars base, rubber braked castors. Lateral side strips of the backrest and of the seat covered in black eco-leather; backrest cover in black polypropylene.

Dimensioni		Dimensions	
Altezza totale (cm)	86	Total height (inches)	33 3/4
Altezza sedile (cm)	45	Seat height (inches)	17 3/4
Larghezza max. con braccioli (cm)	65	Max width with armrests (inches)	25 3/4
Profondità totale (cm)	58	Total depth (inches)	22 3/4
Peso max. (kg)	15	Weight max. (kg)	15
Volume (m³)	0,18	Volume (m³)	0,18
Tessuto (m²)	1,00	Fabric (yards)	1,10
Pelle (m²)	1,80	Leather (sq. feet)	19,4

Code		Price €
ZYLOGICK03EYA	Rivestimento in cat. A - Cover in cat. A	581,00
ZYLOGICK03EYB	Rivestimento in cat. B - Cover in cat. B	616,00
ZYLOGICK03EYD	Rivestimento in cat. D - Cover in cat. D	721,00

Base in alluminio Lucido Polished aluminum base	130,00
Synchron Basic Synchron Basic	98,00
Synchron Self con traslatore sedile Synchron Self with sliding seat	168,00
Braccioli in nylon nero regolabili in altezza Height-adjustable black nylon armrests	91,00
Braccioli in nylon nero fissi a forma triangolare Fixed and triangular shaped black nylon armrests	77,00
Braccioli in nylon nero fissi a forma di T Fixed T shaped black nylon armrests	84,00



Poltrona operativa con schienale in rete "Mughetto", senza braccioli, meccanismo girevole, elevazione a gas, base a 5 razze in nylon nero, ruote autofrenanti gommata. Rivestimento della fascia laterale della seduta in ecopelle nera.
Task armchair with "Mughetto" mesh backrest, without armrests, swivel mechanism, gas lift, black nylon 5 stars base, rubber braked castors. Lateral side strips of the seat covered in black eco-leather.

Dimensioni		Dimensions	
Altezza totale (cm)	91	Total height (inches)	35 7/8
Altezza sedile (cm)	45	Seat height (inches)	17 7/8
Larghezza max. con braccioli (cm)	65	Max width with armrests (inches)	25 5/8
Profondità totale (cm)	58	Total depth (inches)	22 7/8
Peso max. (kg)	15	Weight max. (kg)	15
Volume (m³)	0,18	Volume (m³)	0,18
Tessuto (ml)	0,65	Fabric (yards)	0,72
Pelle (m²)	1,20	Leather (sq. feet)	12,9

Code		Price €
ZYLOGICLK02EYA	Rivestimento in cat. A - Cover in cat. A	504,00
ZYLOGICLK02EYB	Rivestimento in cat. B - Cover in cat. B	522,00
ZYLOGICLK02EYD	Rivestimento in cat. D - Cover in cat. D	574,00

Base in alluminio Lucido	130,00
Polished aluminum base	
Sincron basic	98,00
Sincron basic	
Sincron Self con traslatore sedile	168,00
Sincron Self with sliding seat	
Braccioli in nylon nero regolabili in altezza	91,00
Height-adjustable black nylon armrests	
Braccioli in nylon nero fissi a forma triangolare	77,00
Fixed and triangular shaped black nylon armrests	
Braccioli in nylon nero fissi a forma di T	84,00
Fixed T shaped black nylon armrests	



Sedia visitatore imbottita con braccioli, struttura cantilever verniciata nera. Rivestimento della fascia laterale dello schienale e della seduta in ecopelle nera.
Padded visitor chair with armrests, black epoxy powder coated skid frame. Lateral side strips of the backrest and of the seat covered in black eco-leather.

Dimensioni		Dimensions	
Altezza totale (cm)	82	Total height (inches)	32 3/4
Altezza sedile (cm)	48	Seat height (inches)	18 7/8
Larghezza (cm)	61	Width (inches)	24"
Profondità totale (cm)	59	Total depth (inches)	23 3/4
Peso (kg)	8	Weight max. (kg)	8
Volume (m³)	0,40	Volume (m³)	0,40
Tessuto (ml)	0,70	Fabric (yards)	0,77
Pelle (m²)	1,30	Leather (sq. feet)	14,0

Code		Price €
ZYLOGICLK3ENA	Rivestimento in cat. A - Cover in cat. A	532,00
ZYLOGICLK3ENB	Rivestimento in cat. B - Cover in cat. B	553,00
ZYLOGICLK3END	Rivestimento in cat. D - Cover in cat. D	620,00

Struttura cromata	46,00
Chromed frame	



Poltrona direzionale imbottita, con braccioli, meccanismo oscillante Eco, elevazione a gas, base a 5 razze in alluminio lucido, ruote autofrenanti gommata.
Executive armchair with padded shell, with armrests, tilting Eco mechanism, gas lift, polished aluminum 5 stars base, rubber braked castors.

Dimensioni		Dimensions	
Altezza totale (cm)	103	Total height (inches)	40 7/8
Altezza sedile (cm)	45	Seat height (inches)	17 7/8
Larghezza max. con braccioli (cm)	58	Max width with armrests (inches)	22 7/8
Profondità totale (cm)	68	Total depth (inches)	26 5/8
Peso max. (kg)	17	Weight max. (kg)	17
Volume (m³)	0,40	Volume (m³)	0,40

Code		Price €
ZYOFCOUOMA3HCA	Rivestimento in cat. A - Cover in cat. A	1544,00
ZYOFCOUOMA3HCB	Rivestimento in cat. B - Cover in cat. B	1582,00
ZYOFCOUOMA3HCD	Rivestimento in cat. D - Cover in cat. D	1701,00

Oscillante a fulcro avanzato	147,00
Tilting with advanced pivot point	
Oscillante lusso a fulcro avanzato	168,00
Luxury tilting with advanced pivot point	



Poltrona direzionale in rete "Geranio", con braccioli, meccanismo oscillante Eco, elevazione a gas, base a 5 razze in alluminio lucido, ruote autofrenanti gommata.
Executive armchair with "Geranio" mesh shell, with armrests, tilting Eco mechanism, gas lift, polished aluminum 5 stars base, rubber braked castors.

Dimensioni		Dimensions	
Altezza totale (cm)	103	Total height (inches)	40 7/8
Altezza sedile (cm)	45	Seat height (inches)	17 7/8
Larghezza max. con braccioli (cm)	58	Max width with armrests (inches)	22 7/8
Profondità totale (cm)	68	Total depth (inches)	26 5/8
Peso max. (kg)	17	Weight max. (kg)	17
Volume (m³)	0,40	Volume (m³)	0,40

Code		Price €
ZYOFCOUOMA2HC3	Rivestimento in rete Geranio - Cover in mesh Geranio	1358,00

Oscillante a fulcro avanzato	147,00
Tilting with advanced pivot point	
Oscillante lusso a fulcro avanzato	168,00
Luxury tilting with advanced pivot point	

OF COURSE



Poltrona semi-direzionale imbottita, senza braccioli, meccanismo girevole, elevazione a gas, base a 5 razze in alluminio lucido, ruote autofrenanti gommate.
Manager armchair with padded shell, without armrests, swivel mechanism, gas lift, polished aluminum 5 stars base, rubber braked castors.

Dimensioni		Dimensions	
Altezza totale (cm)	90	Total height (inches)	35 1/2
Altezza sedile (cm)	45	Seat height (inches)	17 3/4
Larghezza max. con braccioli (cm)	58	Max width with armrests (inches)	22 3/4
Profondità totale (cm)	68	Total depth (inches)	26 3/4
Peso max. (kg)	16	Weight max. (kg)	16
Volume (m³)	0,30	Volume (m³)	0,30

Code		Price €
ZYOFCOUOMB2HCA	Rivestimento in cat. A - Cover in cat. A	1253,00
ZYOFCOUOMB2HCB	Rivestimento in cat. B - Cover in cat. B	1288,00
ZYOFCOUOMB2HCD	Rivestimento in cat. D - Cover in cat. D	1407,00
	Girevole con ritorno automatico (piedini al posto delle ruote) Swiveling with self-turning mechanism (feet instead of castors)	60,00
	Oscillante Eco Eco tilting	84,00
	Oscillante a fulcro avanzato Tilting with advanced pivot point	147,00
	Braccioli fissi in alluminio lucido Fixed polished aluminum armrests	238,00



Poltrona semi-direzionale in rete, senza braccioli, meccanismo girevole, elevazione a gas, base a 5 razze in alluminio lucido, ruote autofrenanti gommate.
Manager armchair with mesh shell, without armrests, swivel mechanism, gas lift, polished aluminum 5 stars base, rubber braked castors.

Dimensioni		Dimensions	
Altezza totale (cm)	90	Total height (inches)	35 1/2
Altezza sedile (cm)	45	Seat height (inches)	17 3/4
Larghezza max. con braccioli (cm)	58	Max width with armrests (inches)	22 3/4
Profondità totale (cm)	68	Total depth (inches)	26 3/4
Peso max. (kg)	16	Weight max. (kg)	16
Volume (m³)	0,30	Volume (m³)	0,30

Code		Price €
ZYOFCOUOMB2HC8	Rivestimento in rete Geranio - Cover in mesh Geranio	1078,00
	Girevole con ritorno automatico (piedini al posto delle ruote) Swiveling with self-turning mechanism (feet instead of castors)	60,00
	Oscillante Eco Eco tilting	84,00
	Oscillante a fulcro avanzato Tilting with advanced pivot point	147,00
	Braccioli fissi in alluminio lucido Fixed polished aluminum armrests	238,00

GRADE



Poltrona semi-direzionale imbottita, con braccioli in poliuretano morbido nero, rivestimento fascia laterale dello schienale in ecopelle nera, meccanismo girevole, elevazione a gas, base a 5 razze in alluminio lucido, ruote autofrenanti gommate.
Padded manager armchair, with soft black polyurethane armrests, lateral side strips of the backrest in black eco-leather, swivel mechanism, gas lift, polished aluminum 5 stars base, rubber braked castors.

Dimensioni		Dimensions	
Altezza totale (cm)	101	Total height (inches)	39 3/4
Altezza sedile (cm)	44	Seat height (inches)	17 1/4
Larghezza totale (cm)	63	Total width (inches)	24 3/4
Profondità totale (cm)	63	Total depth (inches)	24 3/4
Peso max. (kg)	21	Weight max. (kg)	21
Volume (m³)	0,35	Volume (m³)	0,35
Tessuto (mtl)	1,60	Fabric (yards)	1,75
Pelle (m²)	2,90	Leather (sq. feet)	31,2

Code		Price €
ZYGRADEGS3HBCA	Rivestimento in cat. A - Cover in cat. A	1407,00
ZYGRADEGS3HBCB	Rivestimento in cat. B - Cover in cat. B	1442,00
ZYGRADEGS3HBCD	Rivestimento in cat. D - Cover in cat. D	1582,00
	Rivestimento con cuscino aggiuntivo Upholstery with additional cushion	200,00
	Sincron Top con traslatore sedile Sincron Top with sliding seat	186,00
	Rivestimento coppia di braccioli in cat. A Upholstery for armrests in cat. A	168,00
	Rivestimento coppia di braccioli in cat. B Upholstery for armrests in cat. B	186,00
	Rivestimento coppia di braccioli in cat. D Upholstery for armrests in cat. D	200,00



Poltrona operativa imbottita, con braccioli in poliuretano morbido nero, rivestimento fascia laterale dello schienale in ecopelle nera, meccanismo girevole, elevazione a gas, base a 5 razze in alluminio lucido, ruote autofrenanti gommate.
Task padded armchair, with soft black polyurethane armrests, lateral side strips of the backrest in black eco-leather, swivel mechanism, gas lift, polished aluminum 5 stars base, rubber braked castors.

Dimensioni		Dimensions	
Altezza totale (cm)	101	Total height (inches)	39 3/4
Altezza sedile (cm)	44	Seat height (inches)	17 1/4
Larghezza totale (cm)	63	Total width (inches)	24 3/4
Profondità totale (cm)	63	Total depth (inches)	24 3/4
Peso max. (kg)	20	Weight max. (kg)	20
Volume (m³)	0,35	Volume (m³)	0,35
Tessuto (mtl)	1,55	Fabric (yards)	1,70
Pelle (m²)	2,80	Leather (sq. feet)	30,0

Code		Price €
ZYGRADEGV3HBCA	Rivestimento in cat. A - Cover in cat. A	1372,00
ZYGRADEGV3HBCB	Rivestimento in cat. B - Cover in cat. B	1407,00
ZYGRADEGV3HBCD	Rivestimento in cat. D - Cover in cat. D	1544,00
	Rivestimento con cuscino aggiuntivo Upholstery with additional cushion	200,00
	Sincron Top con traslatore sedile Sincron Top with sliding seat	186,00
	Rivestimento coppia di braccioli in cat. A Upholstery for armrests in cat. A	168,00
	Rivestimento coppia di braccioli in cat. B Upholstery for armrests in cat. B	186,00
	Rivestimento coppia di braccioli in cat. D Upholstery for armrests in cat. D	200,00

MISSION



Poltroncina riunione imbottita, rivestimento fascia laterale dello schienale e dei braccioli in ecopelle nera, meccanismo girevole, elevazione a gas, base a 5 razze in alluminio lucido, ruote autofrenanti gommata.

Padded meeting armchair, lateral side strips of the backrest and armrests in black eco-leather, swivel mechanism, gas lift, polished aluminum 5 stars base, rubber braked castors.

Dimensioni		Dimensions	
Altezza totale (cm)	78	Total height (inches)	30 3/4
Altezza sedile (cm)	47	Seat height (inches)	18 1/2
Larghezza totale (cm)	62	Total width (inches)	24 3/4
Profondità totale (cm)	60	Total depth (inches)	23 3/4
Peso max. (kg)	14	Weight max. (kg)	14
Volume (m ³)	0,35	Volume (m ³)	0,35
Tessuto (mtl)	1,70	Fabric (yards)	1,90
Pelle (m ²)	3,00	Leather (sq. feet)	32,3

Code		Price €
ZYMISSIMGA3HBA	Rivestimento in cat. A - Cover in cat. A	1232,00
ZYMISSIMGA3HBB	Rivestimento in cat. B - Cover in cat. B	1271,00
ZYMISSIMGA3HBD	Rivestimento in cat. D - Cover in cat. D	1428,00
	Rivestimento fascia braccioli nello stesso tessuto della seduta Upholstery for lateral side strips of armrests in the same fabric of the seat	46,00



Poltroncina riunione imbottita, rivestimento fascia laterale dello schienale e dei braccioli in ecopelle nera, meccanismo girevole, base a 4 razze piatta in alluminio lucido su piedini fissi.

Padded meeting armchair, lateral side strips of the backrest and armrests in black eco-leather, swivel mechanism, polished aluminum 4 stars flat base on feet.

Dimensioni		Dimensions	
Altezza totale (cm)	78	Total height (inches)	30 3/4
Altezza sedile (cm)	47	Seat height (inches)	18 1/2
Larghezza totale (cm)	62	Total width (inches)	24 3/4
Profondità totale (cm)	60	Total depth (inches)	23 3/4
Peso max. (kg)	14	Weight max. (kg)	14
Volume (m ³)	0,35	Volume (m ³)	0,35
Tessuto (mtl)	1,70	Fabric (yards)	1,90
Pelle (m ²)	3,00	Leather (sq. feet)	32,3

Code		Price €
ZYMISSIMGA3H9A	Rivestimento in cat. A - Cover in cat. A	1372,00
ZYMISSIMGA3H9B	Rivestimento in cat. B - Cover in cat. B	1407,00
ZYMISSIMGA3H9D	Rivestimento in cat. D - Cover in cat. D	1568,00
	Rivestimento fascia braccioli nello stesso tessuto della seduta Upholstery for lateral side strips of armrests in the same fabric of the seat	46,00

**SEDUTE OPERATIVE
TASK SEATING**

BEST



Poltroncina operativa con schienale in rete "Mughetto" e sedile imbottito, senza braccioli, meccanismo Synchron Basic, elevazione a gas, base a 5 razze in nylon nero, ruote autofrenanti gommate.

Task armchair with "Mughetto" mesh backrest and padded seat, without armrests, Synchron Basic mechanism, gas lift, black nylon 5 stars base, rubber braked castors.

Dimensioni		Dimensions	
Altezza totale (cm)	102	Total height (inches)	40 ^{3/4}
Altezza sedile (cm)	45	Seat height (inches)	17 ^{3/4}
Larghezza max. con braccioli (cm)	65	Max width with armrests (inches)	25 ^{3/4}
Profondità totale (cm)	57	Total depth (inches)	22 ^{1/2}
Peso max. (kg)	14	Weight max. (kg)	14
Volume (m ³)	0,18	Volume (m ³)	0,18
Tessuto (mtl)	0,65	Fabric (yards)	0,72
Pelle (m ²)	1,20	Leather (sq. feet)	12,9

Code		Price €
ZYBESTTBEO2Y1A	Rivestimento in cat. A - Cover in cat. A	616,00
ZYBESTTBEO2Y1B	Rivestimento in cat. B - Cover in cat. B	637,00
ZYBESTTBEO2Y1D	Rivestimento in cat. D - Cover in cat. D	669,00
	Base in alluminio Lucido Polished aluminum base	84,00
	Base in metallo cromato Chromed metal base	60,00
	Synchron Self con traslatore sedile Synchron Self mechanism with sliding seat	98,00
	Braccioli in nylon nero regolabili in altezza Height-adjustable black nylon armrests	91,00
	Braccioli fissi in nylon nero a forma triangolare Fixed and triangular shaped black nylon armrests	77,00
	Braccioli fissi in nylon nero a forma di T Fixed T shaped black nylon armrests	84,00

WIND



Poltroncina operativa con schienale in polipropilene nero con rete "Genziana" nera e sedile imbottito, senza braccioli, meccanismo Synchron Basic, elevazione a gas, base a 5 razze in nylon nero, ruote autofrenanti gommate.

Task armchair with black polypropylene backrest with "Genziana" black mesh and padded seat, without armrests, Synchron Basic mechanism, gas lift, black nylon 5 stars base, rubber braked castors.

Dimensioni		Dimensions	
Altezza totale (cm)	100	Total height (inches)	39 ^{3/4}
Altezza sedile (cm)	44	Seat height (inches)	17 ^{3/4}
Larghezza totale (cm)	64	Total width (inches)	25 ^{3/4}
Profondità totale (cm)	60	Total depth (inches)	23 ^{3/4}
Peso max. (kg)	19	Weight max. (kg)	19
Volume (m ³)	0,35	Volume (m ³)	0,35
Tessuto (mtl)	0,80	Fabric (yards)	0,90
Pelle (m ²)	1,20	Leather (sq. feet)	12,9

Code		Price €
ZYWINDDWBO2HNA	Rivestimento in cat. A - Cover in cat. A	879,00
ZYWINDDWBO2HNB	Rivestimento in cat. B - Cover in cat. B	875,00
ZYWINDDWBO2HND	Rivestimento in cat. D - Cover in cat. D	949,00
	Base in alluminio lucido Polished aluminum base	147,00
	Base in alluminio verniciato bianco Base in white epoxy powder coated aluminum	165,00
	Schienale in polipropilene bianco con rete bianca White polypropylene backrest with white mesh	70,00
	Braccioli fissi in nylon nero a forma triangolare Fixed black nylon armrests with triangular shape	109,00
	Braccioli in nylon nero regolabili in altezza e larghezza con appoggio in poliuretano morbido Black nylon armrests adjustable in height and width with soft polyurethane pad	154,00
	Braccioli in nylon bianco regolabili in altezza e larghezza con appoggio in poliuretano morbido White nylon armrests adjustable in height and width with soft polyurethane pad	168,00

Sedia attesa impilabile con schienale in polipropilene nero con rete "Genziana" nera e sedile imbottito, senza braccioli, struttura cromata.

Visitor stackable chair with black polypropylene backrest with "Genziana" black mesh and padded seat, without armrests, chromed skid frame.



Dimensioni		Dimensions	
Altezza totale (cm)	85,5	Total height (inches)	33 ^{3/4}
Altezza sedile (cm)	47	Seat height (inches)	18 ^{3/4}
Largh. max con braccioli e tavoletta (cm)	59	Max width with armrests + tablet (inches)	23 ^{3/4}
Profondità totale (cm)	60	Total depth (inches)	23 ^{3/4}
Peso max. con braccioli e tavoletta (kg)	9,30	Weight max. with armrests and tablet (kg)	9,30
Volume (m ³)	0,35	Volume (m ³)	0,35
Tessuto (mtl)	0,60	Fabric (yards)	0,70
Pelle (m ²)	0,90	Leather (sq. feet)	9,7

Code		Price €
ZYWINDDWV2HCNA	Rivestimento in cat. A - Cover in cat. A	427,00
ZYWINDDWV2HCNB	Rivestimento in cat. B - Cover in cat. B	445,00
ZYWINDDWV2HCND	Rivestimento in cat. D - Cover in cat. D	462,00
	Schienale in polipropilene bianco con rete bianca White polypropylene backrest with white mesh	46,00
	Braccioli fissi Fixed armrests	77,00
	Braccioli fissi con tavoletta scrittoio in HPL bianco o nero Fixed armrests with white or black HPL writing tablet	238,00
	Coppia di aggancio corto per sedia senza braccioli Short coupling for chairs without armrests	49,00
	Coppia di aggancio lungo per sedia con braccioli Long couplings for chairs with armrests	70,00

**DIVANI PER AREA ATTESA
SOFAS FOR WAITING AREAS**

CUBIC



Poltrona. Basamento in tondino d'acciaio cromato.
Armchair. Chromed steel rod frame.

Dimensioni		Dimensions	
Altezza totale (cm)	71	Total height (inches)	28"
Altezza sedile (cm)	46	Seat height (inches)	18 1/4"
Larghezza totale (cm)	71	Total width (inches)	28"
Profondità totale (cm)	66	Total depth (inches)	26"
Peso (kg)	24	Weight max. (kg)	24
Volume (m³)	0,35	Volume (m³)	0,35
Tessuto (mtl)	2,30	Fabric (yards)	2,55
Pelle (m²)	4,30	Leather (sq. feet)	46,3

Code		Price €
ZYCUBICCU3H1BA	Rivestimento in cat. A - Cover in cat. A	1320,00
ZYCUBICCU3H1BB	Rivestimento in cat. B - Cover in cat. B	1390,00
ZYCUBICCU3H1BD	Rivestimento in cat. D - Cover in cat. D	1582,00



Divano 2 posti. Basamento in tondino d'acciaio cromato.
2 seater sofa. Chromed steel rod frame.

Dimensioni		Dimensions	
Altezza totale (cm)	71	Total height (inches)	28"
Altezza sedile (cm)	46	Seat height (inches)	18 1/4"
Larghezza totale (cm)	124	Total width (inches)	48 3/4"
Profondità totale (cm)	66	Total depth (inches)	26"
Peso (kg)	30	Weight max. (kg)	30
Volume (m³)	0,60	Volume (m³)	0,60
Tessuto (mtl)	3,30	Fabric (yards)	3,65
Pelle (m²)	6,00	Leather (sq. feet)	64,6

Code		Price €
ZYCUBICCU3H2BA	Rivestimento in cat. A - Cover in cat. A	1694,00
ZYCUBICCU3H2BB	Rivestimento in cat. B - Cover in cat. B	1834,00
ZYCUBICCU3H2BD	Rivestimento in cat. D - Cover in cat. D	2114,00



Divano 3 posti. Basamento in tondino d'acciaio cromato.
3-seater sofa. Chromed steel rod frame.

Dimensioni		Dimensions	
Altezza totale (cm)	71	Total height (inches)	28"
Altezza sedile (cm)	46	Seat height (inches)	18 1/4"
Larghezza totale (cm)	176	Total width (inches)	69 3/4"
Profondità totale (cm)	66	Total depth (inches)	26"
Peso (kg)	36	Weight max. (kg)	36
Volume (m³)	0,90	Volume (m³)	0,90
Tessuto (mtl)	4,30	Fabric (yards)	4,75
Pelle (m²)	7,00	Leather (sq. feet)	75,3

Code		Price €
ZYCUBICCU3H3BA	Rivestimento in cat. A - Cover in cat. A	2163,00
ZYCUBICCU3H3BB	Rivestimento in cat. B - Cover in cat. B	2359,00
ZYCUBICCU3H3BD	Rivestimento in cat. D - Cover in cat. D	2671,00



Panca. Basamento in tondino d'acciaio cromato.
Bench. Chromed steel rod frame.

Dimensioni		Dimensions	
Altezza totale (cm)	46	Total height (inches)	18 1/4"
Larghezza totale (cm)	110	Total width (inches)	69 3/4"
Profondità totale (cm)	66	Total depth (inches)	26"
Peso (kg)	15	Weight max. (kg)	15
Volume (m³)	0,40	Volume (m³)	0,40
Tessuto (mtl)	1,80	Fabric (yards)	2,00
Pelle (m²)	3,50	Leather (sq. feet)	37,7

Code		Price €
ZYCUBICCU3HCPA	Rivestimento in cat. A - Cover in cat. A	1250,00
ZYCUBICCU3HCPB	Rivestimento in cat. B - Cover in cat. B	1288,00
ZYCUBICCU3HCPD	Rivestimento in cat. D - Cover in cat. D	1477,00

WOLF



Poltrona. Basamento in acciaio verniciato nero.
Armchair. Epoxy powder painted black base.

Dimensioni		Dimensions	
Altezza totale (cm)	75	Total height (inches)	29 1/2"
Larghezza totale (cm)	91	Total width (inches)	35 3/4"
Profondità totale (cm)	73	Total depth (inches)	28 3/4"
Tessuto (mtl)	2,40	Fabric (yards)	2,60
Pelle (m²)	4,40	Leather (sq. feet)	47,5

Code		Price €
ZYWOLFWAIT1A	Rivestimento in cat. A - Cover in cat. A	2241,00
ZYWOLFWAIT1B	Rivestimento in cat. B - Cover in cat. B	2284,00
ZYWOLFWAIT1D	Rivestimento in cat. D - Cover in cat. D	2499,00



Divano 2 posti. Basamento in acciaio verniciato nero.
2 seater sofa. Epoxy powder painted black base.

Dimensioni		Dimensions	
Altezza totale (cm)	75	Total height (inches)	29 1/2"
Larghezza totale (cm)	183	Total width (inches)	72"
Profondità totale (cm)	73	Total depth (inches)	28 3/4"
Tessuto (mtl)	4,80	Fabric (yards)	5,20
Pelle (m²)	8,80	Leather (sq. feet)	95,0

Code		Price €
ZYWOLFWAIT2A	Rivestimento in cat. A - Cover in cat. A	4167,00
ZYWOLFWAIT2B	Rivestimento in cat. B - Cover in cat. B	4252,00
ZYWOLFWAIT2D	Rivestimento in cat. D - Cover in cat. D	4681,00



Divano 3 posti. Basamento in acciaio verniciato nero.
3-seater sofa. Epoxy powder painted black base.

Dimensioni		Dimensions	
Altezza totale (cm)	75	Total height (inches)	29 1/2"
Larghezza totale (cm)	274	Total width (inches)	107 3/4"
Profondità totale (cm)	73	Total depth (inches)	28 3/4"
Tessuto (mtl)	7,2	Fabric (yards)	7,80
Pelle (m²)	13,20	Leather (sq. feet)	142,5

Code		Price €
ZYWOLFWAIT3A	Rivestimento in cat. A - Cover in cat. A	5963,00
ZYWOLFWAIT3B	Rivestimento in cat. B - Cover in cat. B	6092,00
ZYWOLFWAIT3D	Rivestimento in cat. D - Cover in cat. D	6735,00



Poltrona con tavolino annesso in melaminico. Basamento in acciaio verniciato nero.
Armchair with attached melamine table. Epoxy powder painted black base.

Dimensioni		Dimensions	
Altezza totale (cm)	75	Total height (inches)	29 1/2"
Larghezza totale (cm)	121	Total width (inches)	47 3/4"
Profondità totale (cm)	73	Total depth (inches)	28 3/4"
Tessuto (mtl)	2,40	Fabric (yards)	2,60
Pelle (m²)	4,40	Leather (sq. feet)	47,5

Code		Price €
ZYWOLFWAIT1EXA	Rivestimento in cat. A - Cover in cat. A	2617,00
ZYWOLFWAIT1EXB	Rivestimento in cat. B - Cover in cat. B	2660,00
ZYWOLFWAIT1EXD	Rivestimento in cat. D - Cover in cat. D	2875,00



Tavolino in melaminico. Basamento in acciaio verniciato nero.
Melamine table. Epoxy powder painted black base.

Dimensioni		Dimensions	
Altezza totale (cm)	23	Total height (inches)	9"
Larghezza totale (cm)	73	Total width (inches)	28 3/4"
Profondità totale (cm)	73	Total depth (inches)	28 3/4"

Code		Price €
ZYWOLFWAITAV	Rivestimento in cat. A - Cover in cat. A	873,00













**MOBILI CONTENITORI
STORAGE CABINETS**

Caratteristiche e finiture disponibili per TUTTI i mobili - Features and finishes available for ALL cabinets

I contenitori, vengono spediti già assemblati. La struttura (base, fianchi, top e schienale), così come le ante ed i frontali dei cassetti sono realizzati in truciolare nobilitato con spessori da 18 mm a 25 mm; i montanti verticali sono dotati di una serie di fori distanziati per consentire l'alloggio dei reggi-ripiani. I ripiani, riposizionabili, sono in pannello truciolare nobilitato. Le ante ed i frontali dei cassetti, tutti in truciolare, sono dotate di una maniglia variabile per ogni modello. Sono disponibili anche ante in cristallo temperato da 6 mm. Sono forniti di cerniere in metallo nichelato con molla di richiamo e sistema di montaggio rapido. Sono dotati di piedini di varie tipologie ma sempre regolabili in altezza.

Storage cabinets are shipped already assembled. The structure (base, sides, top and backrest), as well as the doors and the fronts of the drawers are made of melamine coated chipboard with thicknesses from 18 mm to 25 mm; the vertical panels are equipped with a series of holes to allow the accommodation of the shelf supports. The repositionable shelves are in melamine coated chipboard panel. The doors and drawer fronts, all in chipboard, are equipped with a variable handle for each model. 6 mm. tempered glass doors are also available. They are equipped with nickel-plated metal hinges with return spring and quick assembly system. They are equipped with feet of various types but always adjustable in height.

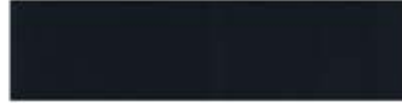
Strutture, ante e frontali dei cassetti in melaminico - Structures, doors and drawer fronts in melamine

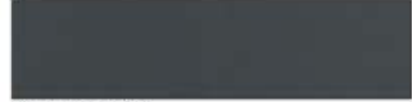
 Lino FA41	 Noce Chiaro LM01	 Rovere Grigio LG18
 Rovere Bianco LK84	 Noce Canaletto LN83	 Rovere Spessart LM76
 Rovere Magister LK97	 Ash S001	
 Bianco B007	 Grigio U110	 Nero U129
 Avorio U100	 Grafite UB08	

Ante in cristallo - Glass doors



Cristallo trasparente
Clear glass

OASIS



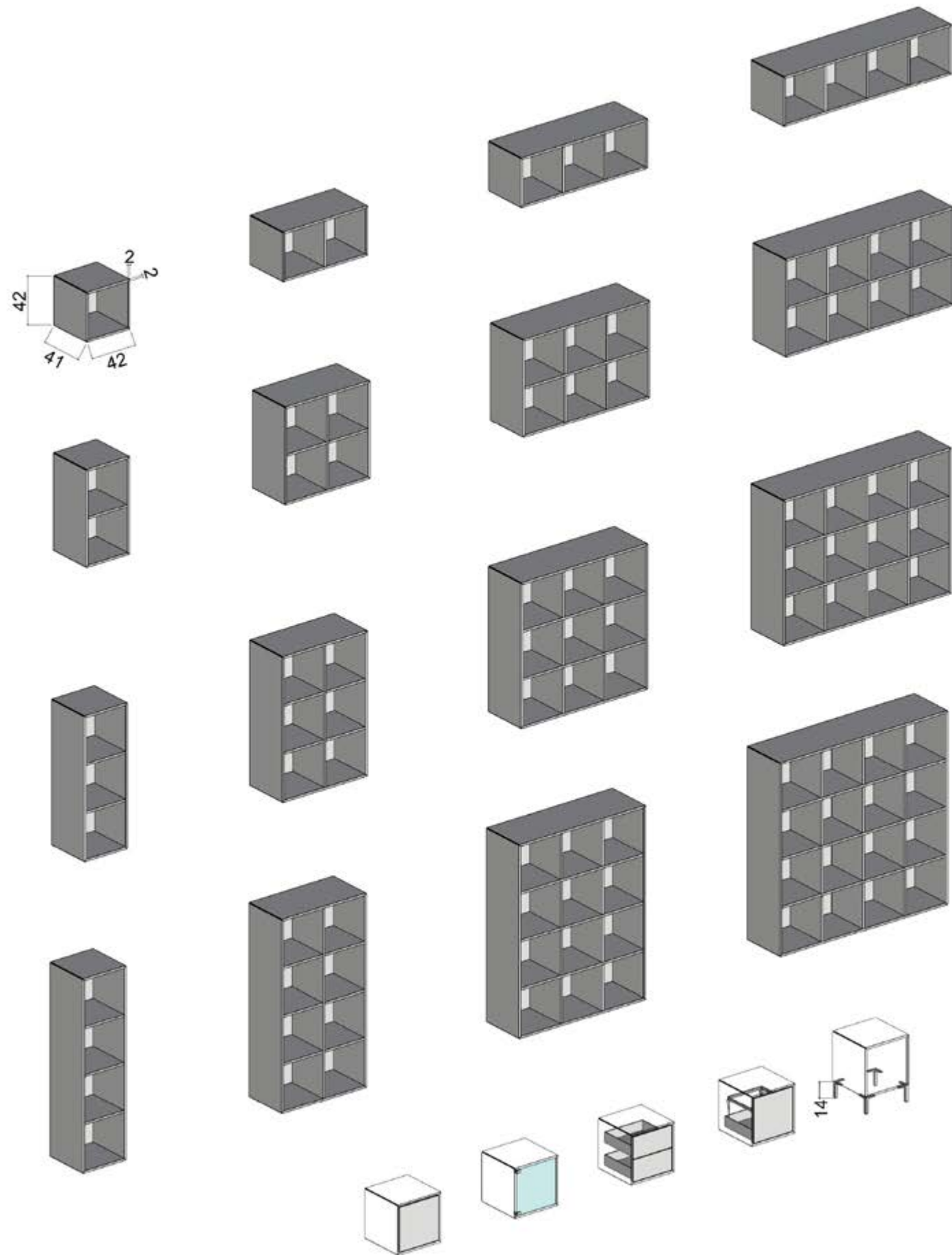

OASIS - Mobili contenitori - Storage cabinets



Vano singolo.
Single unit.

Code	Dimension cm	Dimension inches	Price €
ZZOASISCBN1000	42x41x42h	16 ¹ / ₂ x 16 ¹ / ₈ x 16 ¹ / ₂ h	236,00



Composizione a 2 vani orizzontali.
Composition with 2 horizontal units.

Code	Dimension cm	Dimension inches	Price €
ZZOASISCBN1001	83x41x42h	32 ¹ / ₈ x 16 ¹ / ₈ x 16 ¹ / ₂ h	301,00



Composizione a 2 vani verticali.
Composition with 2 vertical units.

Code	Dimension cm	Dimension inches	Price €
ZZOASISCBN1002	42x41x83h	16 ¹ / ₂ x 16 ¹ / ₈ x 32 ¹ / ₈ h	301,00



Composizione a 3 vani orizzontali.
Composition with 3 horizontal units.

Code	Dimension cm	Dimension inches	Price €
ZZOASISCBN1003	123x41x42h	48 ¹ / ₂ x 16 ¹ / ₈ x 16 ¹ / ₂ h	410,00



Composizione a 3 vani verticali.
Composition with 3 vertical units.

Code	Dimension cm	Dimension inches	Price €
ZZOASISCBN1004	42x41x123h	16 ¹ / ₂ x 16 ¹ / ₈ x 48 ¹ / ₂ h	410,00



Composizione a 4 vani.
Composition with 4 units.

Code	Dimension cm	Dimension inches	Price €
ZZOASISCBN1005	83x41x83h	32 ¹ / ₈ x 16 ¹ / ₈ x 32 ¹ / ₈ h	461,00



Composizione a 4 vani orizzontali.
Composition with 4 horizontal units.

Code	Dimension cm	Dimension inches	Price €
ZZOASISCBN1006	163,5x41x42h	64 ¹ / ₈ x 16 ¹ / ₈ x 16 ¹ / ₂ h	476,00

OASIS - Mobili contenitori - Storage cabinets



Composizione a 4 vani verticali.
Composition with 4 vertical units.

Code	Dimension cm	Dimension inches	Price €
ZZOASISCBN1007	42x41x163,5h	16 ¹ / ₂ x 16 ¹ / ₈ x 64 ¹ / ₂ h	476,00



Composizione a 6 vani orizzontali.
Composition with 6 horizontal units.

Code	Dimension cm	Dimension inches	Price €
ZZOASISCBN1008	123x41x83h	48 ¹ / ₂ x 16 ¹ / ₈ x 32 ¹ / ₂ h	612,00



Composizione a 6 vani verticali.
Composition with 6 vertical units.

Code	Dimension cm	Dimension inches	Price €
ZZOASISCBN1009	83x41x123h	32 ¹ / ₈ x 16 ¹ / ₈ x 48 ¹ / ₂ h	612,00

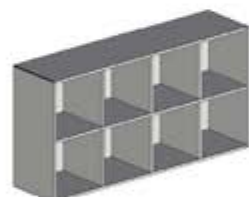

Composizione a 8 vani orizzontali.
Composition with 8 horizontal units.

Code	Dimension cm	Dimension inches	Price €
ZZOASISCBN1010	163,5x41x83h	64 ¹ / ₈ x 16 ¹ / ₈ x 32 ¹ / ₂ h	715,00



Composizione a 8 vani verticali.
Composition with 8 vertical units.

Code	Dimension cm	Dimension inches	Price €
ZZOASISCBN1011	83x41x163,5h	32 ¹ / ₈ x 16 ¹ / ₈ x 64 ¹ / ₂ h	715,00

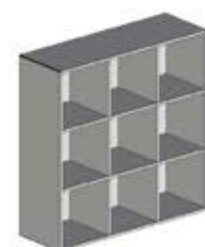

Composizione a 9 vani.
Composition with 9 units.

Code	Dimension cm	Dimension inches	Price €
ZZOASISCBN1012	123x41x123h	48 ¹ / ₂ x 16 ¹ / ₈ x 48 ¹ / ₂ h	761,00

OASIS - Mobili contenitori - Storage cabinets

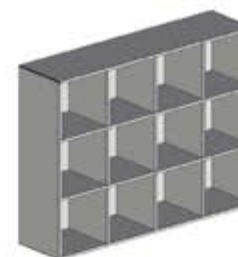

Composizione a 12 vani orizzontali.
Composition with 12 horizontal units.

Code	Dimension cm	Dimension inches	Price €
ZZOASISCBN1013	163,5x41x123h	64 ¹ / ₈ x 16 ¹ / ₈ x 48 ¹ / ₂ h	919,00

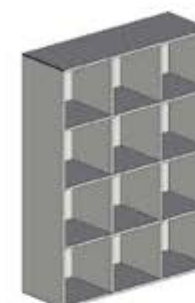

Composizione a 12 vani verticali.
Composition with 12 vertical units.

Code	Dimension cm	Dimension inches	Price €
ZZOASISCBN1014	123x41x163,5h	48 ¹ / ₂ x 16 ¹ / ₈ x 64 ¹ / ₂ h	919,00

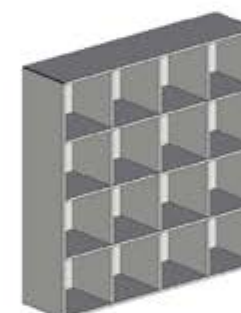

Composizione a 16 vani.
Composition with 16 units.

Code	Dimension cm	Dimension inches	Price €
ZZOASISCBN1015	163,5x41x163,5h	64 ¹ / ₈ x 16 ¹ / ₈ x 64 ¹ / ₂ h	1124,00



Anta destra o sinistra in melaminico con apertura push & pull.
Right or left melamine door with push & pull opening.

Code	Price €
ZZOASISCBN1016	137,00



Anta destra o sinistra in cristallo con apertura push & pull.
Right or left glass door with push & pull opening.

Code	Price €
ZZOASISCBN1017	162,00



Due cassetti in melaminico con apertura push & pull.
Two melamine drawers with push & pull opening.

Code	Price €
ZZOASISCBN1018	407,00

OASIS - Mobili contenitori - Storage cabinets



Un classificatore in melaminico con apertura push & pull.
One melamine file drawer with push & pull opening.

Code	Price €
ZZOASISCBN1019	240,00



Kit di 4 piedini in alluminio anodizzato.
Kit of 4 anodized aluminum feet.

Code	Dimension cm	Dimension inches	Price €
ZZOASISCBN1020	14h	5 $\frac{1}{2}$ h	161,00

BASIC



Maniglia - Handle

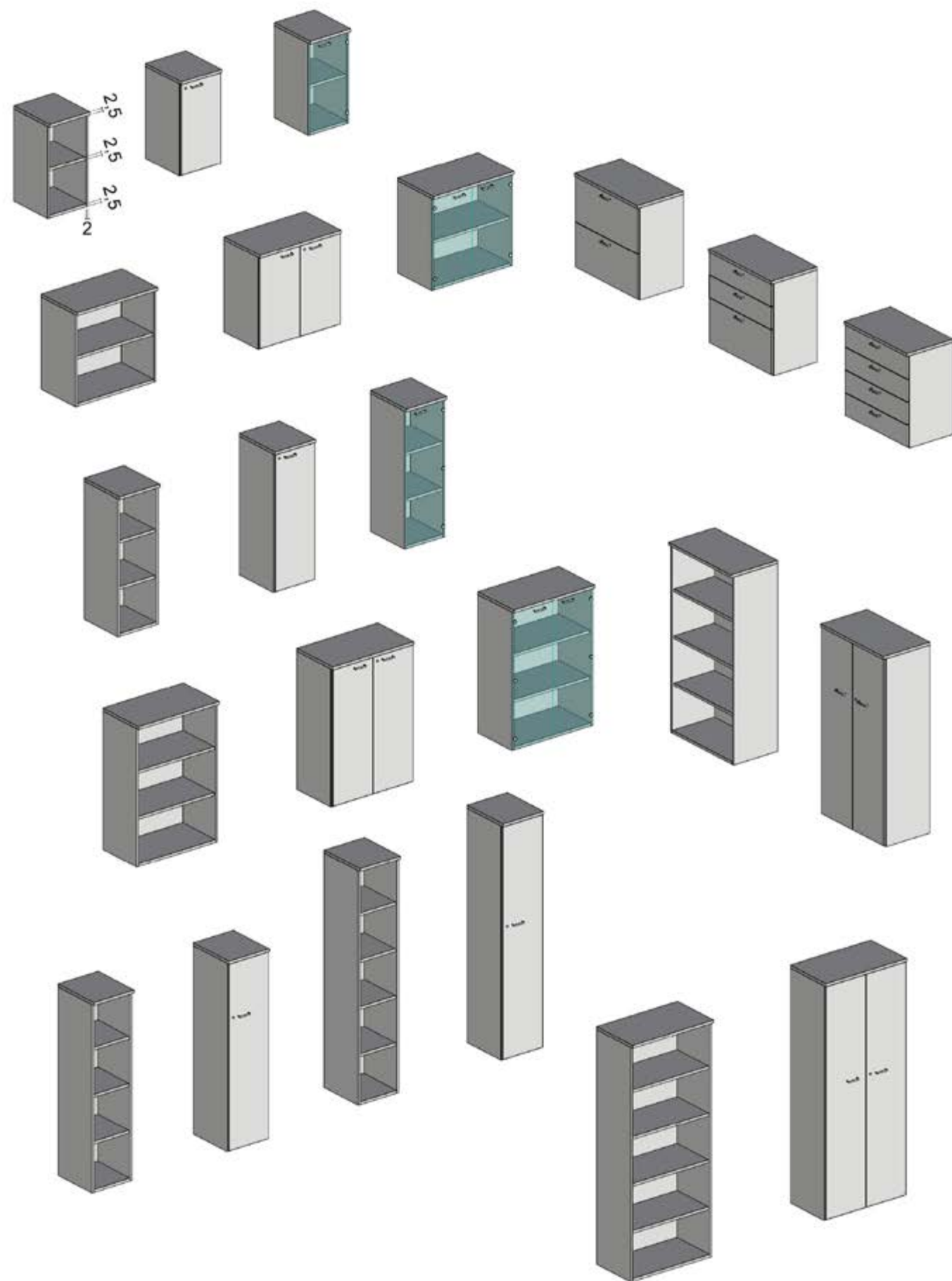

BASIC - Mobili contenitori - Storage cabinets



Contenitore a giorno con un ripiano. Adatto ad essere sovrapposto ad altri elementi.
Open cabinet with one shelf. Suitable to be superimposed on other elements.

Code	Dimension cm	Dimension inches	Price €
ZZBASICCBN2000	40x46x82h	15 ³ / ₄ x 18 ¹ / ₄ x 32 ¹ / ₄ h	340,00



Contenitore con un'anta in melaminico con serratura e con un ripiano. Adatto ad essere sovrapposto ad altri elementi.
Cabinet with one melamine door with lock and with one shelf. Suitable to be superimposed on other elements.

Code	Dimension cm	Dimension inches	Price €
ZZBASICCBN2001	40x46x82h	15 ³ / ₄ x 18 ¹ / ₄ x 32 ¹ / ₄ h	433,00

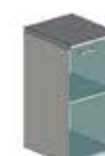

Contenitore con un'anta in vetro con un ripiano. Adatto ad essere sovrapposto ad altri elementi.
Cabinet with one glass door and with one shelf. Suitable to be superimposed on other elements.

Code	Dimension cm	Dimension inches	Price €
ZZBASICCBN2002	40x46x82h	15 ³ / ₄ x 18 ¹ / ₄ x 32 ¹ / ₄ h	509,00



Contenitore a giorno con un ripiano. Adatto ad essere sovrapposto ad altri elementi.
Open cabinet with one shelf. Suitable to be superimposed on other elements.

Code	Dimension cm	Dimension inches	Price €
ZZBASICCBN2003	80x46x82h	31 ¹ / ₂ x 18 ¹ / ₄ x 32 ¹ / ₄ h	442,00



Contenitore con due ante in melaminico con serratura e con un ripiano. Adatto ad essere sovrapposto ad altri elementi.
Cabinet with two melamine doors with lock and with one shelf. Suitable to be superimposed on other elements.

Code	Dimension cm	Dimension inches	Price €
ZZBASICCBN2004	80x46x82h	31 ¹ / ₂ x 18 ¹ / ₄ x 32 ¹ / ₄ h	653,00

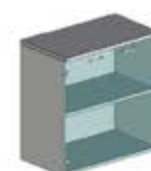

Contenitore con due ante in vetro e con un ripiano. Adatto ad essere sovrapposto ad altri elementi.
Cabinet with two glass doors and with one shelf. Suitable to be superimposed on other elements.

Code	Dimension cm	Dimension inches	Price €
ZZBASICCBN2005	80x46x82h	31 ¹ / ₂ x 18 ¹ / ₄ x 32 ¹ / ₄ h	780,00



Contenitore con due classicatori in melaminico.
Cabinet with two melamine file drawers.

Code	Dimension cm	Dimension inches	Price €
ZZBASICCBN2006	80x46x82h	31 ¹ / ₂ x 18 ¹ / ₄ x 32 ¹ / ₄ h	1005,00

BASIC - Mobili contenitori - Storage cabinets



Contenitore con due cassetti e un classificatore in melaminico.
Cabinet with two drawers and one file drawer in melamine.

Code	Dimension cm	Dimension inches	Price €
ZZBASICCBN2007	80x46x82h	31 ¹ / ₂ x 18 ¹ / ₄ x 32 ³ / ₄ h	1120,00



Contenitore con quattro cassetti in melaminico.
Cabinet with four melamine drawers.

Code	Dimension cm	Dimension inches	Price €
ZZBASICCBN2008	80x46x82h	31 ¹ / ₂ x 18 ¹ / ₄ x 32 ³ / ₄ h	1230,00



Contenitore a giorno con due ripiani. Adatto ad essere sovrapposto ad altri elementi.
Open cabinet with two shelves. Suitable to be superimposed on other elements.

Code	Dimension cm	Dimension inches	Price €
ZZBASICCBN2100	40x46x121h	15 ³ / ₄ x 18 ¹ / ₄ x 47 ¹ / ₂ h	438,00



Contenitore con un'anta in melaminico con serratura e con due ripiani. Adatto ad essere sovrapposto ad altri elementi.
Cabinet with one melamine door with lock and with two shelves. Suitable to be superimposed on other elements.

Code	Dimension cm	Dimension inches	Price €
ZZBASICCBN2101	40x46x121h	15 ³ / ₄ x 18 ¹ / ₄ x 47 ¹ / ₂ h	593,00



Contenitore con un'anta in vetro con due ripiani. Adatto ad essere sovrapposto ad altri elementi.
Cabinet with one glass door and with two shelves. Suitable to be superimposed on other elements.

Code	Dimension cm	Dimension inches	Price €
ZZBASICCBN2102	40x46x121h	15 ³ / ₄ x 18 ¹ / ₄ x 47 ¹ / ₂ h	652,00



Contenitore a giorno con due ripiani. Adatto ad essere sovrapposto ad altri elementi.
Open cabinet with two shelves. Suitable to be superimposed on other elements.

Code	Dimension cm	Dimension inches	Price €
ZZBASICCBN2103	80x46x121h	31 ¹ / ₂ x 18 ¹ / ₄ x 47 ¹ / ₂ h	586,00

BASIC - Mobili contenitori - Storage cabinets



Contenitore con due ante in melaminico con serratura e con due ripiani. Adatto ad essere sovrapposto ad altri elementi.
Cabinet with two melamine doors with lock and with two shelves. Suitable to be superimposed on other elements.

Code	Dimension cm	Dimension inches	Price €
ZZBASICCBN2104	80x46x121h	31 ¹ / ₂ x 18 ¹ / ₄ x 47 ¹ / ₂ h	857,00



Contenitore con due ante in vetro e con due ripiani. Adatto ad essere sovrapposto ad altri elementi.
Cabinet with two glass doors and with two shelves. Suitable to be superimposed on other elements.

Code	Dimension cm	Dimension inches	Price €
ZZBASICCBN2105	80x46x121h	31 ¹ / ₂ x 18 ¹ / ₄ x 47 ¹ / ₂ h	1013,00



Contenitore a giorno con tre ripiani. Adatto ad essere sovrapposto ad altri elementi.
Open cabinet with three shelves. Suitable to be superimposed on other elements.

Code	Dimension cm	Dimension inches	Price €
ZZBASICCBN2200	40x46x164h	15 ³ / ₄ x 18 ¹ / ₄ x 64 ¹ / ₂ h	548,00



Contenitore con un'anta in melaminico con serratura e con tre ripiani. Adatto ad essere sovrapposto ad altri elementi.
Cabinet with one melamine door with lock and with three shelves. Suitable to be superimposed on other elements.

Code	Dimension cm	Dimension inches	Price €
ZZBASICCBN2201	40x46x164h	15 ³ / ₄ x 18 ¹ / ₄ x 64 ¹ / ₂ h	772,00



Contenitore a giorno con tre ripiani. Adatto ad essere sovrapposto ad altri elementi.
Open cabinet with three shelves. Suitable to be superimposed on other elements.

Code	Dimension cm	Dimension inches	Price €
ZZBASICCBN2202	80x46x164h	31 ¹ / ₂ x 18 ¹ / ₄ x 64 ¹ / ₂ h	647,00

BASIC - Mobili contenitori - Storage cabinets



Contenitore con due ante in melaminico con serratura e con tre ripiani. Adatto ad essere sovrapposto ad altri elementi.
Cabinet with two melamine doors with lock and with three shelves. Suitable to be superimposed on other elements.

Code	Dimension cm	Dimension inches	Price €
ZZBASICCBN2203	80x46x164h	31 ¹ / ₂ x 18 ¹ / ₄ x 64 ¹ / ₂ h	967,00



Contenitore a giorno con quattro ripiani. Adatto ad essere sovrapposto ad altri elementi.
Open cabinet with four shelves. Suitable to be superimposed on other elements.

Code	Dimension cm	Dimension inches	Price €
ZZBASICCBN2300	40x46x203h	15 ¹ / ₄ x 18 ¹ / ₄ x 79 ¹ / ₂ h	611,00



Contenitore con un'anta in melaminico con serratura e con quattro ripiani. Adatto ad essere sovrapposto ad altri elementi.
Cabinet with one melamine door with lock and with four shelves. Suitable to be superimposed on other elements.

Code	Dimension cm	Dimension inches	Price €
ZZBASICCBN2301	40x46x203h	15 ¹ / ₄ x 18 ¹ / ₄ x 79 ¹ / ₂ h	810,00



Contenitore a giorno con quattro ripiani. Adatto ad essere sovrapposto ad altri elementi.
Open cabinet with four shelves. Suitable to be superimposed on other elements.

Code	Dimension cm	Dimension inches	Price €
ZZBASICCBN2302	80x46x203h	31 ¹ / ₂ x 18 ¹ / ₄ x 79 ¹ / ₂ h	819,00

BASIC - Mobili contenitori - Storage cabinets



Contenitore con due ante in melaminico con serratura e con quattro ripiani. Adatto ad essere sovrapposto ad altri elementi.
Cabinet with two melamine doors with lock and with four shelves. Suitable to be superimposed on other elements.

Code	Dimension cm	Dimension inches	Price €
ZZBASICCBN2303	80x46x203h	31 ¹ / ₂ x 18 ¹ / ₄ x 79 ¹ / ₂ h	1147,00

SQUAD



Maniglia - Handle

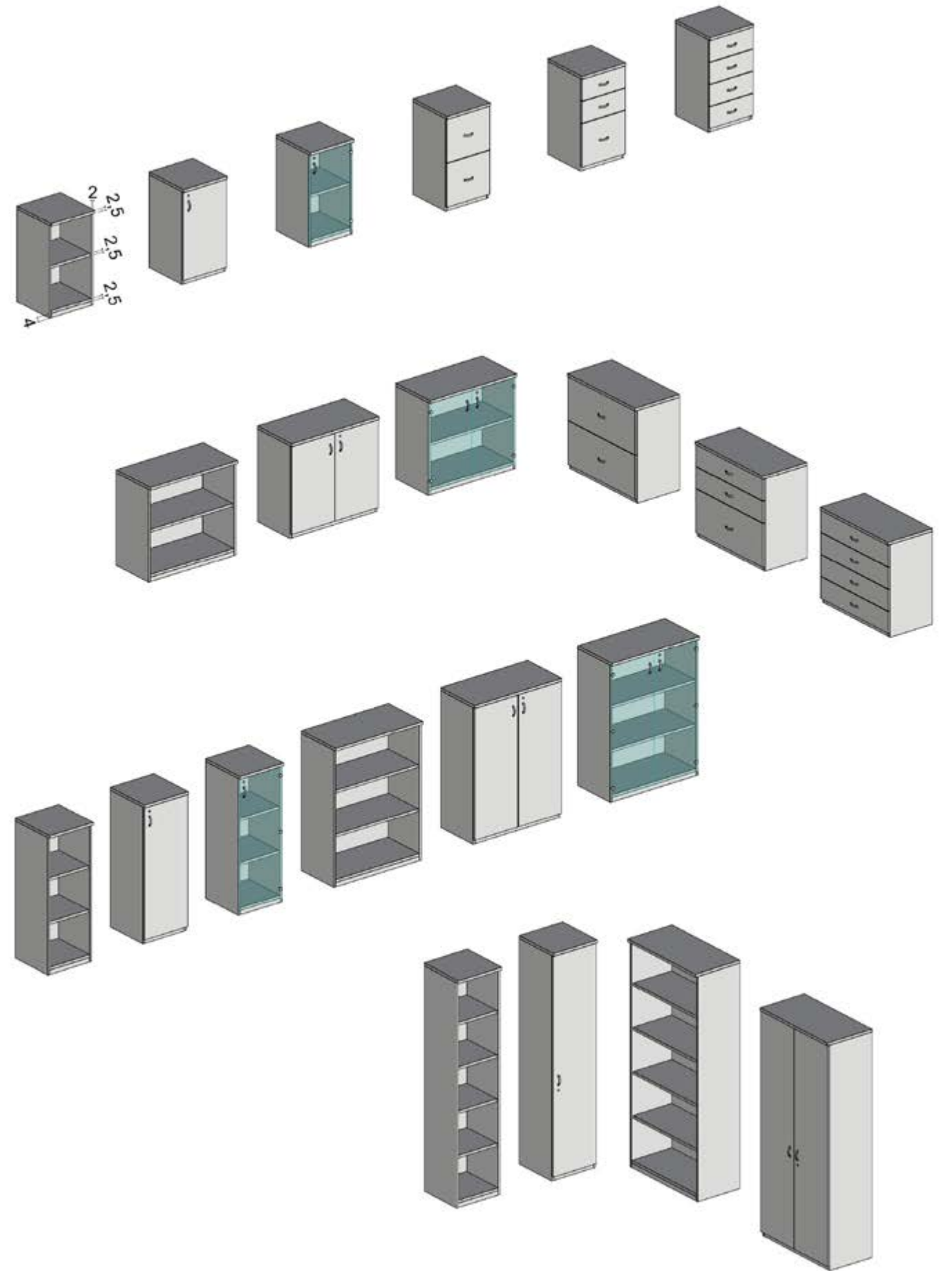

SQUAD - Mobili contenitori - Storage cabinets

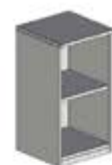

Contenitore a giorno con un ripiano.
Open cabinet with one shelf.

Code	Dimension cm	Dimension inches	Price €
ZZSQUADCBN4000	45x46x85h	17 ¹ / ₄ x 18 ¹ / ₄ x 33 ¹ / ₂ h	373,00



Contenitore con un'anta in melaminico con serratura e con un ripiano.
Cabinet with one melamine door with lock and with one shelf.

Code	Dimension cm	Dimension inches	Price €
ZZSQUADCBN4001	45x46x85h	17 ¹ / ₄ x 18 ¹ / ₄ x 33 ¹ / ₂ h	498,00



Contenitore con un'anta in vetro con serratura e con un ripiano.
Cabinet with one glass door with lock and with one shelf.

Code	Dimension cm	Dimension inches	Price €
ZZSQUADCBN4002	45x46x85h	17 ¹ / ₄ x 18 ¹ / ₄ x 33 ¹ / ₂ h	594,00



Contenitore con due classificatori in melaminico.
Cabinet with two melamine file drawers.

Code	Dimension cm	Dimension inches	Price €
ZZSQUADCBN4003	45x46x85h	17 ¹ / ₄ x 18 ¹ / ₄ x 33 ¹ / ₂ h	755,00



Contenitore con due cassetti e un classificatore in melaminico.
Cabinet with two drawers and one file drawer in melamine.

Code	Dimension cm	Dimension inches	Price €
ZZSQUADCBN4004	45x46x85h	17 ¹ / ₄ x 18 ¹ / ₄ x 33 ¹ / ₂ h	979,00



Contenitore con quattro cassetti in melaminico.
Cabinet with four melamine drawers.

Code	Dimension cm	Dimension inches	Price €
ZZSQUADCBN4005	45x46x85h	17 ¹ / ₄ x 18 ¹ / ₄ x 33 ¹ / ₂ h	987,00



Contenitore a giorno con un ripiano.
Open cabinet with one shelf.

Code	Dimension cm	Dimension inches	Price €
ZZSQUADCBN4006	90x46x85h	35 ¹ / ₂ x 18 ¹ / ₄ x 33 ¹ / ₂ h	479,00



Contenitore con due ante in melaminico con serratura e con un ripiano.
Cabinet with two melamine doors with lock and with one shelf.

Code	Dimension cm	Dimension inches	Price €
ZZSQUADCBN4007	90x46x85h	35 ¹ / ₂ x 18 ¹ / ₄ x 33 ¹ / ₂ h	687,00

SQUAD - Mobili contenitori - Storage cabinets



Contenitore con due ante in vetro con serratura e con un ripiano.
Cabinet with two glass doors with lock and with one shelf.

Code	Dimension cm	Dimension inches	Price €
ZZSQUADCBN4008	90x46x85h	35 ¹ / ₂ x 18 ¹ / ₄ x 33 ¹ / ₂ h	878,00



Contenitore con due classificatori in melaminico.
Cabinet with two melamine file drawers.

Code	Dimension cm	Dimension inches	Price €
ZZSQUADCBN4009	90x46x85h	35 ¹ / ₂ x 18 ¹ / ₄ x 33 ¹ / ₂ h	1067,00



Contenitore con due cassetti e un classificatore in melaminico.
Cabinet with two drawers and one file drawer in melamine.

Code	Dimension cm	Dimension inches	Price €
ZZSQUADCBN4010	90x46x85h	35 ¹ / ₂ x 18 ¹ / ₄ x 33 ¹ / ₂ h	1180,00



Contenitore con quattro cassetti in melaminico.
Cabinet with four melamine drawers.

Code	Dimension cm	Dimension inches	Price €
ZZSQUADCBN4011	90x46x85h	35 ¹ / ₂ x 18 ¹ / ₄ x 33 ¹ / ₂ h	1316,00



Contenitore a giorno con due ripiani.
Open cabinet with two shelves.

Code	Dimension cm	Dimension inches	Price €
ZZSQUADCBN4100	45x46x125h	17 ¹ / ₄ x 18 ¹ / ₄ x 49 ¹ / ₄ h	492,00



Contenitore con un'anta in melaminico con serratura e con due ripiani.
Cabinet with one melamine door with lock and with two shelves.

Code	Dimension cm	Dimension inches	Price €
ZZSQUADCBN4101	45x46x125h	17 ¹ / ₄ x 18 ¹ / ₄ x 49 ¹ / ₄ h	636,00



Contenitore con un'anta in vetro con serratura e con due ripiani.
Cabinet with one glass door with lock and with two shelves.

Code	Dimension cm	Dimension inches	Price €
ZZSQUADCBN4102	45x46x125h	17 ¹ / ₄ x 18 ¹ / ₄ x 49 ¹ / ₄ h	871,00

SQUAD - Mobili contenitori - Storage cabinets



Contenitore a giorno con due ripiani.
Open cabinet with two shelves.

Code	Dimension cm	Dimension inches	Price €
ZZSQUADCBN4103	90x46x125h	35 ¹ / ₂ x 18 ¹ / ₄ x 49 ¹ / ₄ h	625,00



Contenitore con due ante in melaminico con serratura e con due ripiani.
Cabinet with two melamine doors with lock and with two shelves.

Code	Dimension cm	Dimension inches	Price €
ZZSQUADCBN4104	90x46x125h	35 ¹ / ₂ x 18 ¹ / ₄ x 49 ¹ / ₄ h	914,00

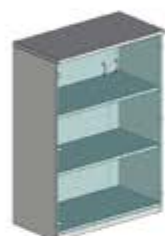

Contenitore con due ante in vetro con serratura e con due ripiani.
Cabinet with two glass doors with lock and with two shelves.

Code	Dimension cm	Dimension inches	Price €
ZZSQUADCBN4105	90x46x125h	35 ¹ / ₂ x 18 ¹ / ₄ x 49 ¹ / ₄ h	1147,00



Contenitore a giorno con quattro ripiani.
Open cabinet with four shelves.

Code	Dimension cm	Dimension inches	Price €
ZZSQUADCBN4200	45x46x204h	17 ¹ / ₄ x 18 ¹ / ₄ x 80 ¹ / ₂ h	650,00



Contenitore con un'anta in melaminico con serratura e con quattro ripiani.
Cabinet with one melamine door with lock and with four shelves.

Code	Dimension cm	Dimension inches	Price €
ZZSQUADCBN4201	45x46x204h	17 ¹ / ₄ x 18 ¹ / ₄ x 80 ¹ / ₂ h	839,00

SQUAD - Mobili contenitori - Storage cabinets



Contenitore a giorno con quattro ripiani.
Open cabinet with four shelves.

Code	Dimension cm	Dimension inches	Price €
ZZSQUADCBN4202	90x46x204h	35 ¹ / ₂ x 18 ¹ / ₄ x 80 ¹ / ₂ h	877,00



Contenitore con due ante in melaminico con serratura e con quattro ripiani.
Cabinet with two melamine doors with lock and with four shelves.

Code	Dimension cm	Dimension inches	Price €
ZZSQUADCBN4203	90x46x204h	35 ¹ / ₂ x 18 ¹ / ₄ x 80 ¹ / ₂ h	1225,00

MAJOR



Maniglia - Handle

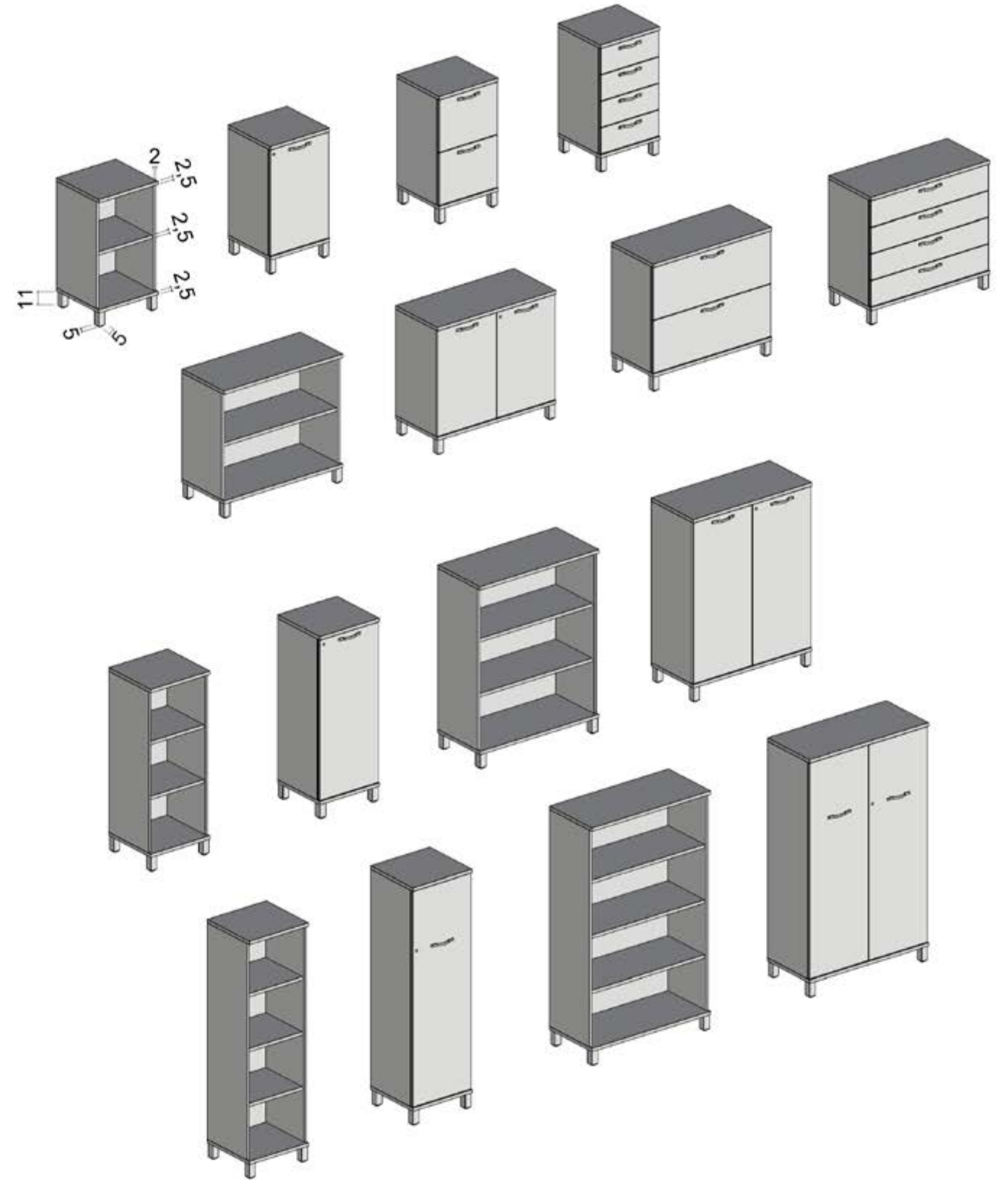

MAJOR - Mobili contenitori - Storage cabinets

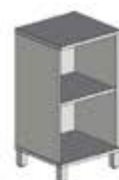

Contenitore a giorno con un ripiano.
Open cabinet with one shelf.

Code	Dimension cm	Dimension inches	Price €
ZZMAJORCBN3000	50x46x94h	19 ¹ / ₈ x 18 ¹ / ₈ x 37" h	397,00
Con piedini - With feet			
ZZMAJORCBN3001	50x46x83h	19 ¹ / ₈ x 18 ¹ / ₈ x 32 ¹ / ₂ " h	342,00
Senza piedini - Without feet			



Contenitore con un'anta in melaminico con serratura e con un ripiano.
Cabinet with one melamine door with lock and with one shelf.

Code	Dimension cm	Dimension inches	Price €
ZZMAJORCBN3002	50x46x94h	19 ¹ / ₈ x 18 ¹ / ₈ x 37" h	534,00
Con piedini - With feet			
ZZMAJORCBN3003	50x46x83h	19 ¹ / ₈ x 18 ¹ / ₈ x 32 ¹ / ₂ " h	479,00
Senza piedini - Without feet			



Contenitore con due classificatori in melaminico.
Cabinet with two melamine file drawers.

Code	Dimension cm	Dimension inches	Price €
ZZMAJORCBN3004	50x46x94h	19 ¹ / ₈ x 18 ¹ / ₈ x 37" h	787,00



Contenitore con quattro cassetti in melaminico.
Cabinet with four melamine drawers.

Code	Dimension cm	Dimension inches	Price €
ZZMAJORCBN3005	50x46x94h	19 ¹ / ₈ x 18 ¹ / ₈ x 37" h	1021,00



Contenitore a giorno con un ripiano.
Open cabinet with one shelf.

Code	Dimension cm	Dimension inches	Price €
ZZMAJORCBN3006	100x46x94h	39 ¹ / ₈ x 18 ¹ / ₈ x 37" h	529,00
Con piedini - With feet			
ZZMAJORCBN3007	100x46x83h	39 ¹ / ₈ x 18 ¹ / ₈ x 32 ¹ / ₂ " h	475,00
Senza piedini - Without feet			



Contenitore con due ante in melaminico con serratura e con un ripiano.
Cabinet with two melamine doors with lock and with one shelf.

Code	Dimension cm	Dimension inches	Price €
ZZMAJORCBN3008	100x46x94h	39 ¹ / ₈ x 18 ¹ / ₈ x 37" h	735,00
Con piedini - With feet			
ZZMAJORCBN3009	100x46x83h	39 ¹ / ₈ x 18 ¹ / ₈ x 32 ¹ / ₂ " h	681,00
Senza piedini - Without feet			

MAJOR - Mobili contenitori - Storage cabinets



Contenitore con due classificatori in melaminico.
Cabinet with two melamine file drawers.

Code	Dimension cm	Dimension inches	Price €
ZZMAJORCBN3010	100x46x94h	39 ¹ / ₈ x 18 ¹ / ₈ x 37" h	1160,00



Contenitore con quattro cassetti in melaminico.
Cabinet with four melamine drawers.

Code	Dimension cm	Dimension inches	Price €
ZZMAJORCBN3011	100x46x94h	39 ¹ / ₈ x 18 ¹ / ₈ x 37" h	1407,00



Contenitore a giorno con due ripiani.
Open cabinet with two shelves.

Code	Dimension cm	Dimension inches	Price €
ZZMAJORCBN3100	50x46x134h	19 ¹ / ₈ x 18 ¹ / ₈ x 52 ¹ / ₈ " h	504,00
Con piedini - With feet			
ZZMAJORCBN3101	50x46x123h	19 ¹ / ₈ x 18 ¹ / ₈ x 48 ¹ / ₂ " h	449,00
Senza piedini - Without feet			



Contenitore con un'anta in melaminico con serratura e con due ripiani.
Cabinet with one melamine door with lock and with two shelves.

Code	Dimension cm	Dimension inches	Price €
ZZMAJORCBN3102	50x46x134h	19 ¹ / ₈ x 18 ¹ / ₈ x 52 ¹ / ₈ " h	665,00
Con piedini - With feet			
ZZMAJORCBN3103	50x46x123h	19 ¹ / ₈ x 18 ¹ / ₈ x 48 ¹ / ₂ " h	611,00
Senza piedini - Without feet			



Contenitore a giorno con due ripiani.
Open cabinet with two shelves.

Code	Dimension cm	Dimension inches	Price €
ZZMAJORCBN3104	100x46x134h	39 ¹ / ₈ x 18 ¹ / ₈ x 52 ¹ / ₈ " h	686,00
Con piedini - With feet			
ZZMAJORCBN3105	100x46x123h	39 ¹ / ₈ x 18 ¹ / ₈ x 48 ¹ / ₂ " h	632,00
Senza piedini - Without feet			



Contenitore con due ante in melaminico con serratura e con due ripiani.
Cabinet with two melamine doors with lock and with two shelves.

Code	Dimension cm	Dimension inches	Price €
ZZMAJORCBN3106	100x46x134h	39 ¹ / ₈ x 18 ¹ / ₈ x 52 ¹ / ₈ " h	948,00
Con piedini - With feet			
ZZMAJORCBN3107	100x46x123h	39 ¹ / ₈ x 18 ¹ / ₈ x 48 ¹ / ₂ " h	894,00
Senza piedini - Without feet			

MAJOR - Mobili contenitori - Storage cabinets

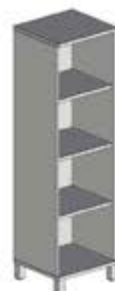

Contenitore a giorno con tre ripiani.
Open cabinet with three shelves.

Code	Dimension cm	Dimension inches	Price €
ZZMAJORCBN3200	50x46x174h	19 ¹ / ₈ x 18 ¹ / ₈ x 68 ¹ / ₂ h	645,00
Con piedini - With feet			
ZZMAJORCBN3201	50x46x163h	19 ¹ / ₈ x 18 ¹ / ₈ x 64 ¹ / ₄ h	590,00
Senza piedini - Without feet			



Contenitore con un'anta in melaminico con serratura e con tre ripiani.
Cabinet with one melamine door with lock and with three shelves.

Code	Dimension cm	Dimension inches	Price €
ZZMAJORCBN3202	50x46x174h	19 ¹ / ₈ x 18 ¹ / ₈ x 68 ¹ / ₂ h	820,00
Con piedini - With feet			
ZZMAJORCBN3203	50x46x163h	19 ¹ / ₈ x 18 ¹ / ₈ x 64 ¹ / ₄ h	766,00
Senza piedini - Without feet			



Contenitore a giorno con tre ripiani.
Open cabinet with three shelves.

Code	Dimension cm	Dimension inches	Price €
ZZMAJORCBN3204	100x46x174h	39 ¹ / ₈ x 18 ¹ / ₈ x 68 ¹ / ₂ h	834,00
Con piedini - With feet			
ZZMAJORCBN3205	100x46x163h	39 ¹ / ₈ x 18 ¹ / ₈ x 64 ¹ / ₄ h	779,00
Senza piedini - Without feet			



Contenitore con due ante in melaminico con serratura e con tre ripiani.
Cabinet with two melamine doors with lock and with three shelves.

Code	Dimension cm	Dimension inches	Price €
ZZMAJORCBN3206	100x46x174h	39 ¹ / ₈ x 18 ¹ / ₈ x 68 ¹ / ₂ h	1140,00
Con piedini - With feet			
ZZMAJORCBN3207	100x46x163h	39 ¹ / ₈ x 18 ¹ / ₈ x 64 ¹ / ₄ h	1085,00
Senza piedini - Without feet			

OPEN

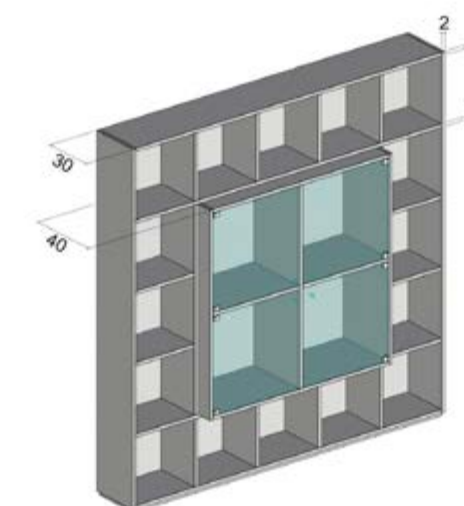

OPEN - Mobili contenitori - Storage cabinets

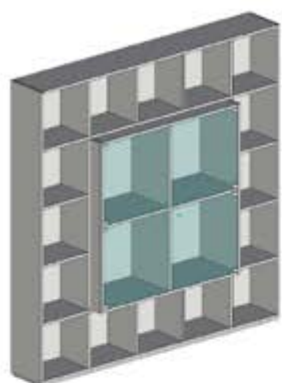

Mobile con vani a giorno e quattro ante in cristallo.
Cabinet with open units and four glass doors.

Code	Dimension cm	Dimension inches	Price €
ZZOPENNCBN5000	200x30/40x202h	78 ¹ / ₄ x 11 ³ / ₄ -15 ³ / ₄ x 79 ¹ / ₂ t	4355,00

**BANCONE RECEPTION
RECEPTION COUNTER**

PASSAGE

Il bancone reception è realizzato in truciolare nobilitato con spessori di 60 mm ed è disponibile con due tipologie di finiture per la parte di appoggio del pubblico: in cuoietto oppure in vetro sabbato con strisce trasparenti. Naturalmente è adattabile alle esigenze di dimensione del cliente.

The reception counter is made of melamine coated chipboard with thicknesses of 60 mm and is available with two types of finishes for the public contact area: in saddle leather or in sandblasted glass with transparent strips. Of course it is adaptable to the size needs of the customer.



Finiture disponibili - Finishes available

Melaminico - Melamine



Rovere Bianco LK84



Rovere Grigio LG18



Rovere Spessart LM76

Cuoietto - Saddle leather



CS 950



CS 956



CS 957



CS 955



CS 953



CS 954

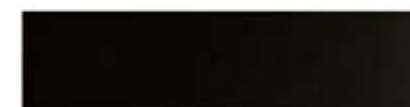

CS 952

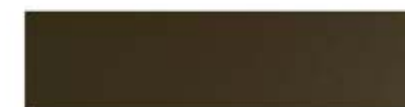

CS 951



CS 958

Vetro sabbato con strisce trasparenti - Sandblasted glass with transparent strips



PASSAGE - Bancone reception - Reception counter

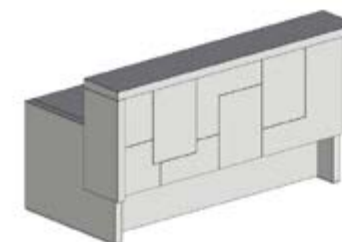

Bancone reception in melaminico con piano di lavoro ad altezza 74 cm. Piano di appoggio lato pubblico in melaminico con fronte rivestito in cuoietto.
Reception counter in melamine with worktop at a height of 74 cm. Public side top in melamine with front covered in saddle leather.

Code	Dimension cm	Dimension inches	Price €
ZZPASSAGERECE01	200x100x74/109h	78 ³ / ₄ x 39 ³ / ₄ x 29 ³ / ₄ -42 ³ / ₄ h	5705,00

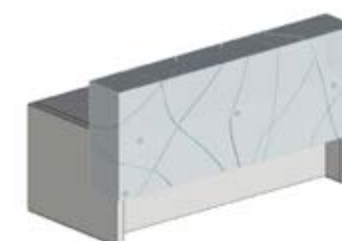

Bancone reception in melaminico con piano di lavoro ad altezza 74 cm. Piano di appoggio lato pubblico in melaminico con fronte in vetro temperato sabbato decorato con strisce trasparenti.
Reception counter in melamine with worktop at a height of 74 cm. Public side top in melamine with front in sandblasted tempered glass decorated with transparent strips.

Code	Dimension cm	Dimension inches	Price €
ZZPASSAGERECE02	200x100x74/109h	78 ³ / ₄ x 39 ³ / ₄ x 29 ³ / ₄ -42 ³ / ₄ h	8608,00

**PARETI ATTREZZATE
EQUIPPED PARTITION**

EQUIPE



Maniglia - Handle

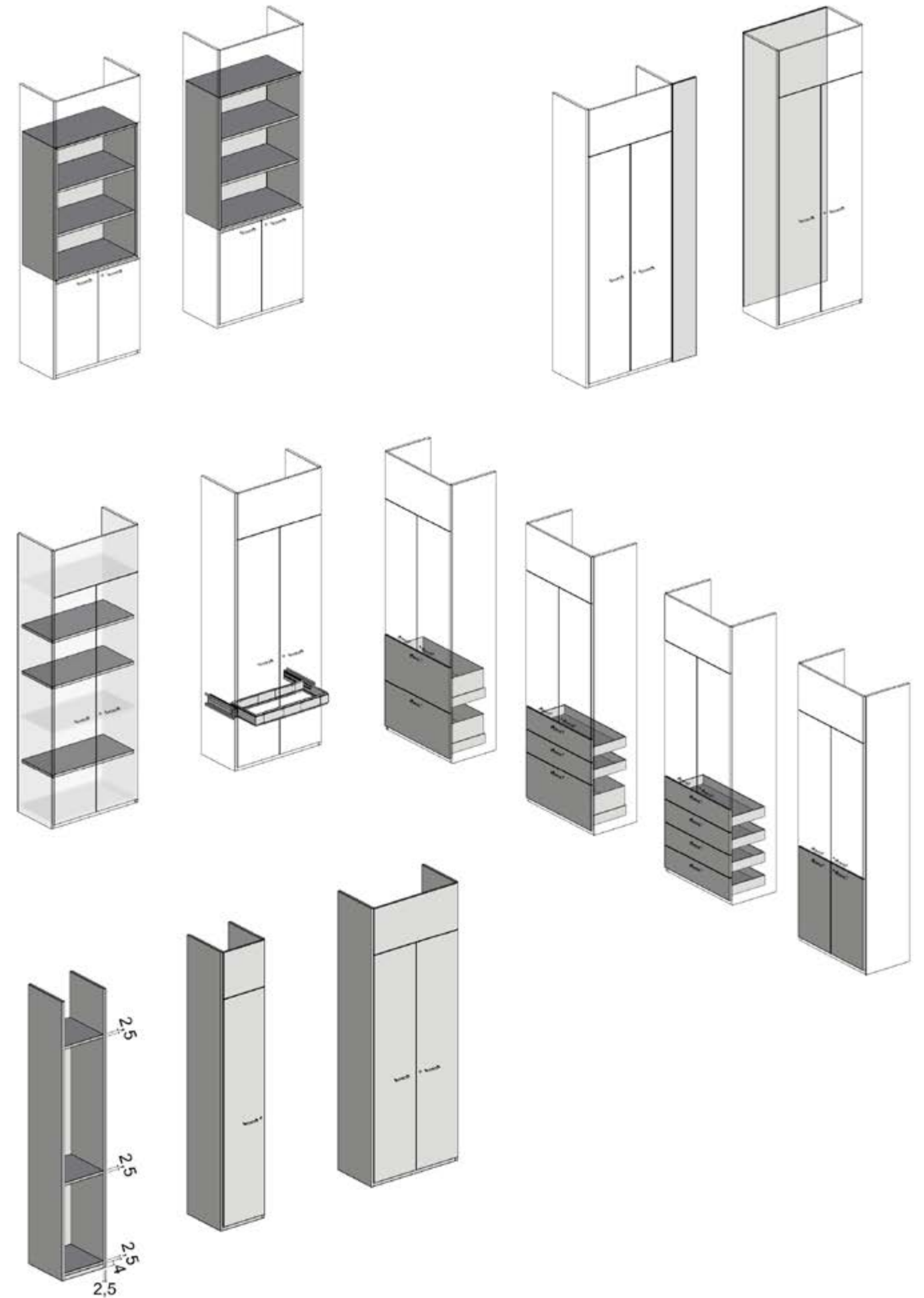













Caratteristiche e finiture disponibili - Features and finishes available

Le pareti attrezzate vengono assemblate presso la destinazione finale e quindi sono spedite smontate. Sono disponibili moduli di due larghezze (45 cm e 90 cm) e 3 range di altezze (214-255 cm, 255-297 cm e 297-339 cm). La struttura (base, fianchi, top e schienale), così come le ante ed i frontali dei cassetti sono realizzati in truciolare nobilitato con spessori da 18 mm a 25 mm e sono dotati di una serie di fori per consentire l'alloggio dei reggi-ripiani. I ripiani, riposizionabili, sono in pannello truciolare nobilitato o in metallo verniciato. Le cerniere sono in metallo nichelato con molla di richiamo e sistema di montaggio rapido mentre i piedini sono regolabili in altezza.

The equipped partitions are assembled at the final destination and are then shipped disassembled. Modules are available in two widths (45 cm and 90 cm) and 3 ranges of heights (214-255 cm, 255-297 cm and 297-339 cm). The structure (base, sides, top and backrest), as well as the doors and the fronts of the drawers are made of melamine coated chipboard with thicknesses from 18 mm to 25 mm and are equipped with a series of holes to allow accommodation of the shelf supports. The repositionable shelves are in melamine coated chipboard panel or in epoxy powder painted metal sheet. The hinges are in nickel-plated metal with return spring and quick assembly system while the feet are adjustable in height.

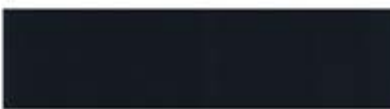
Strutture, ante e frontali dei cassetti in melaminico - Structures, doors and drawer fronts in melamine

		
Lino FA41	Noce Chiaro LM01	Rovere Grigio LG18
		
Rovere Bianco LK84	Noce Canaletto LN83	Rovere Spessart LM76
		
Rovere Magister LK97	Ash S001	
		
Bianco B007	Grigio U110	Nero U129
		
Avorio U100	Grafite UB08	

EQUIPE - Parete attrezzata - Equipped partition



Elemento L 45 cm composto da basamento, spalla laterale, schienale, due ripiani fissi, pannello superiore di tamponamento ed una anta con serratura.
Element W 45 cm composed of base, side panel, backrest, two fixed shelves, upper filling panel and a door with lock.

Code	Dimension cm	Dimension inches	Price €
ZZEQUIPEPRT6000	45x48x214-255h	17 ³ / ₄ x 18 ³ / ₈ x 84 ¹ / ₄ -100 ³ / ₈ h	786,00
ZZEQUIPEPRT6002	45x48x255-297h	17 ³ / ₄ x 18 ³ / ₈ x 100 ³ / ₈ -116 ¹ / ₂ h	932,00
ZZEQUIPEPRT6004	45x48x297-339h	17 ³ / ₄ x 18 ³ / ₈ x 116 ¹ / ₈ -133 ¹ / ₂ h	1129,00



Elemento L 90 cm composto da basamento, spalla laterale, schienale, due ripiani fissi, pannello superiore di tamponamento e due ante con serratura.
Element W 90 cm composed of base, side panel, backrest, two fixed shelves, upper filling panel and two doors with lock.

Code	Dimension cm	Dimension inches	Price €
ZZEQUIPEPRT6001	90x48x214-255h	35 ¹ / ₂ x 18 ³ / ₈ x 84 ¹ / ₄ -100 ³ / ₈ h	917,00
ZZEQUIPEPRT6003	90x48x255-297h	35 ¹ / ₂ x 18 ³ / ₈ x 100 ³ / ₈ -116 ¹ / ₂ h	1339,00
ZZEQUIPEPRT6005	90x48x297-339h	35 ¹ / ₂ x 18 ³ / ₈ x 116 ¹ / ₈ -133 ¹ / ₂ h	1549,00



Spalla laterale di chiusura della parete.
Side panel for wall closing.

Code	Altezza cm	Height inches	Price €
ZZEQUIPEPRT6010	214-255h	84 ¹ / ₄ -100 ³ / ₈ h	277,00
ZZEQUIPEPRT6011	255-297h	100 ³ / ₈ -116 ¹ / ₂ h	293,00
ZZEQUIPEPRT6012	297-339h	116 ¹ / ₈ -133 ¹ / ₂ h	309,00



Supplemento di prezzo per inserimento di un'anta con serratura per parte bassa di un elemento L 45 cm.
Price surcharge for inserting a door with lock for the lower part of an element W 45 cm.

Code	Price €
ZZEQUIPEPRT6013	154,00



Supplemento di prezzo per inserimento di due ante con serratura per parte bassa di un elemento L 90 cm.
Price surcharge for inserting two doors with lock for the lower part of an element W 90 cm.

Code	Price €
ZZEQUIPEPRT6014	252,00

EQUIPE - Parete attrezzata - Equipped partition



Supplemento di prezzo per inserimento di due classificatori per parte bassa di un elemento L 45 cm.
Price surcharge for inserting two file drawers for the lower part of an element W 45 cm.

Code	Price €
ZZEQUIPEPRT6015	461,00



Supplemento di prezzo per inserimento di due classificatori per parte bassa di un elemento L 90 cm.
Price surcharge for inserting two file drawers for the lower part of an element W 90 cm.

Code	Price €
ZZEQUIPEPRT6016	705,00



Supplemento di prezzo per inserimento di due cassetti e un classificatore per parte bassa di un elemento L 45 cm.
Price surcharge for inserting two drawers and one file drawer for the lower part of an element W 45 cm.

Code	Price €
ZZEQUIPEPRT6017	560,00



Supplemento di prezzo per inserimento di due cassetti e un classificatore per parte bassa di un elemento L 90 cm.
Price surcharge for inserting two drawers and one file drawer for the lower part of an element W 90 cm.

Code	Price €
ZZEQUIPEPRT6018	856,00



Supplemento di prezzo per inserimento di quattro cassetti per parte bassa di un elemento L 45 cm.
Price surcharge for inserting four drawers for the lower part of an element W 45 cm.

Code	Price €
ZZEQUIPEPRT6019	702,00

EQUIPE - Parete attrezzata - Equipped partition



Supplemento di prezzo per inserimento di quattro cassetti per parte bassa di un elemento L 90 cm.
Price surcharge for inserting four drawers for the lower part of an element W 90 cm.

Code	Price €
ZZEQUIPEPRT6020	975,00



Supplemento di prezzo per inserimento di un telaio estraibile per supporto cartelle per elemento L 45 cm.
Price surcharge for inserting an extractable frame for file support for element W 45 cm.

Code	Price €
ZZEQUIPEPRT6021	194,00



Supplemento di prezzo per inserimento di un telaio estraibile per supporto cartelle per elemento L 90 cm.
Price surcharge for inserting an extractable frame for file support for element W 90 cm.

Code	Price €
ZZEQUIPEPRT6022	270,00



Ripiano in melaminico per elemento L 45 cm.
Melamine shelf for element W 45 cm.

Code	Price €
ZZEQUIPEPRT6006	114,00



Ripiano in melaminico per elemento L 90 cm.
Melamine shelf for element W 90 cm.

Code	Price €
ZZEQUIPEPRT6007	133,00



Ripiano in metallo per elemento L 45 cm.
Metal sheet shelf for element W 45 cm.

Code	Price €
ZZEQUIPEPRT6008	124,00

EQUIPE - Parete attrezzata - Equipped partition



Ripiano in metallo per elemento L 90 cm.
Metal sheet shelf for element W 90 cm.

Code	Price €
ZZEQUIPEPRT6009	148,00



Supplemento di prezzo per inserimento di un vano a giorno con due ripiani per parte centrale di un elemento L 45 cm.
Price surcharge for inserting an open compartment with two shelves for the central part of an element W 45 cm.

Code	Price €
ZZEQUIPEPRT6023	423,00



Supplemento di prezzo per inserimento di un vano a giorno con due ripiani per parte centrale di un elemento L 90 cm.
Price surcharge for inserting an open compartment with two shelves for the central part of an element W 90 cm.

Code	Price €
ZZEQUIPEPRT6024	539,00



Pannello di tamponamento laterale con larghezza compresa fra 5 e 25 cm.
Side closing panel with a width between 5 and 25 cm.

Code	Altezza cm	Height inches	Price €
ZZEQUIPEPRT6025	214-255h	84 ¹ / ₄ -100 ³ / ₈ h	213,00
ZZEQUIPEPRT6026	255-297h	100 ³ / ₈ -116 ¹ / ₂ h	221,00
ZZEQUIPEPRT6027	297-339h	116 ¹ / ₈ -133 ¹ / ₂ h	229,00



Pannello di finitura per schienale per parete attrezzata a centro stanza per elemento L 45 cm.
Finishing backrest panel for equipped partition positioned in the center of the room for element W 45 cm.

Code	Altezza cm	Height inches	Price €
ZZEQUIPEPRT6028	214-255h	84 ¹ / ₄ -100 ³ / ₈ h	244,00
ZZEQUIPEPRT6030	255-297h	100 ³ / ₈ -116 ¹ / ₂ h	347,00
ZZEQUIPEPRT6032	297-339h	116 ¹ / ₈ -133 ¹ / ₂ h	406,00

EQUIPE - Parete attrezzata - Equipped partition



Pannello di finitura per schienale per parete attrezzata a centro stanza per elemento L 90 cm.
Finishing backrest panel for equipped partition positioned in the center of the room for element W 90 cm.

Code	Altezza cm	Height inches	Price €
ZZEQUIPEPRT6029	214-255h	84 ¹ / ₄ -100 ³ / ₈ h	391,00
ZZEQUIPEPRT6031	255-297h	100 ³ / ₈ -116 ¹ / ₂ h	464,00
ZZEQUIPEPRT6033	297-339h	116 ¹ / ₈ -133 ¹ / ₂ h	509,00

**PARETI DIVISORIE
PARTITION WALLS**

Caratteristiche e finiture disponibili per TUTTE le pareti divisorie - Features and finishes available for ALL partition walls

La struttura di tutte le tipologie di parete divisoria è costituita da profili di alluminio estruso con 4 spessori diversi e disponibile in finitura anodizzata naturale oppure verniciato in colore bianco (RAL 9010) o nero (RAL 9005). Essa è costituita da una traversa superiore ed una inferiore che vengono fissate a soffitto e pavimento rispettivamente, oltre a dei montanti verticali che assicurano la stabilità della struttura stessa. Delle guarnizioni in morbido PVC sono poste lungo tutto il perimetro della struttura, per garantire la tenuta acustica.

I pannelli di chiusura delle strutture sono disponibili in due tipologie:

- pannello melaminico singolo o doppio;
- vetro laminato con interposto un film fonoassorbente in PVB o vetro temperato. Disponibili singoli o doppi e con finitura trasparente oppure sabbiata.

In base al tipo e numero di pannelli, il potere fonoassorbente della parete divisoria cambia in maniera sensibile.

La stessa tipologia di pannellatura è disponibile anche per i diversi moduli porta a battente o scorrevole.

I prezzi di seguito riportati sono in Euro/mq. e sono indicativi. Per una valutazione corretta e definitiva sarà necessario uno sviluppo dimensionale e economico del progetto da parte del nostro ufficio tecnico.

The structure of all types of dividing wall is made up of extruded aluminum profiles with 4 different thicknesses and available in natural anodized finish or painted in white (RAL 9010) or black (RAL 9005). It consists of an upper and a lower crossbar which are fixed to the ceiling and floor respectively, as well as vertical uprights which ensure the stability of the structure itself. Soft PVC gaskets are placed along the entire perimeter of the structure, to ensure acoustic sealing.

The closing panels of the structures are available in two types:

- single or double melamine panel;
- laminated glass with a PVB sound-absorbing film interposed or tempered glass. Available single or double and with clear or sandblasted finish.

Depending on the type and number of panels, the sound-absorbing power of the partition wall changes significantly.

The same type of paneling is also available for the different swing or sliding door modules.

The prices listed below are in Euro/sqm. and are indicative. For a correct and definitive evaluation it will be necessary a dimensional and economic development of the project by our technical department.

Pannelli in melaminico - Melamine panels

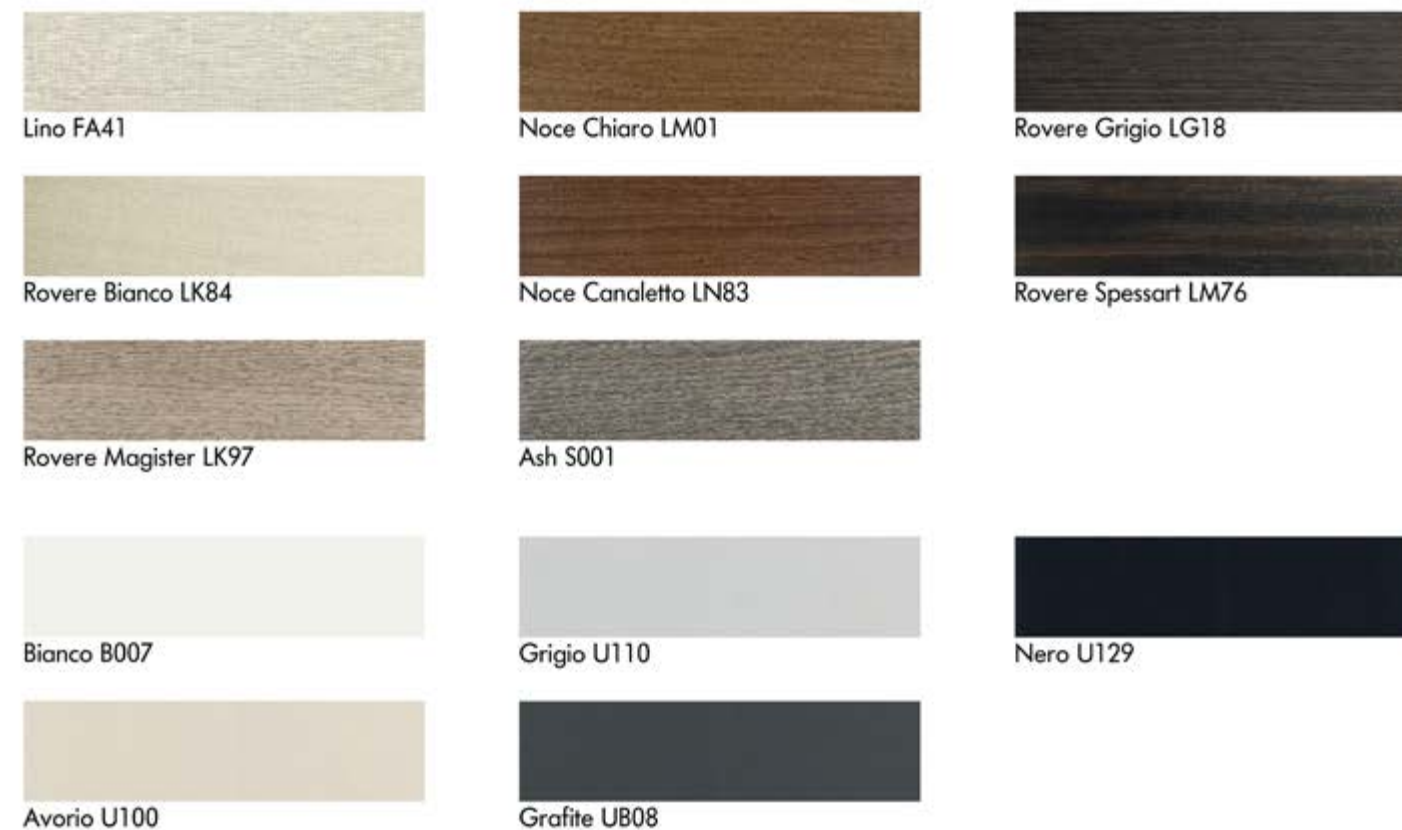

Vetro - Glass



Vetro trasparente
Clear glass



Vetro satinato
Sandblasted glass

Profili - Profiles



Alluminio anodizzato naturale
Natural anodized aluminum



Bianco (RAL 9010)
White (RAL 9010)



Nero (RAL 9005)
White (RAL 9005)

Maniglie disponibili per moduli porta a battente - Available handles for swing door modules



A forma di "C" arrotondata
in inox satinato
Rounded "C" shaped stainless steel

A forma di "L" arrotondata
in inox satinato
Rounded "L" shaped stainless steel

A forma di "L" squadrata
in inox satinato
Squared "L" shaped stainless steel



HUNDRED

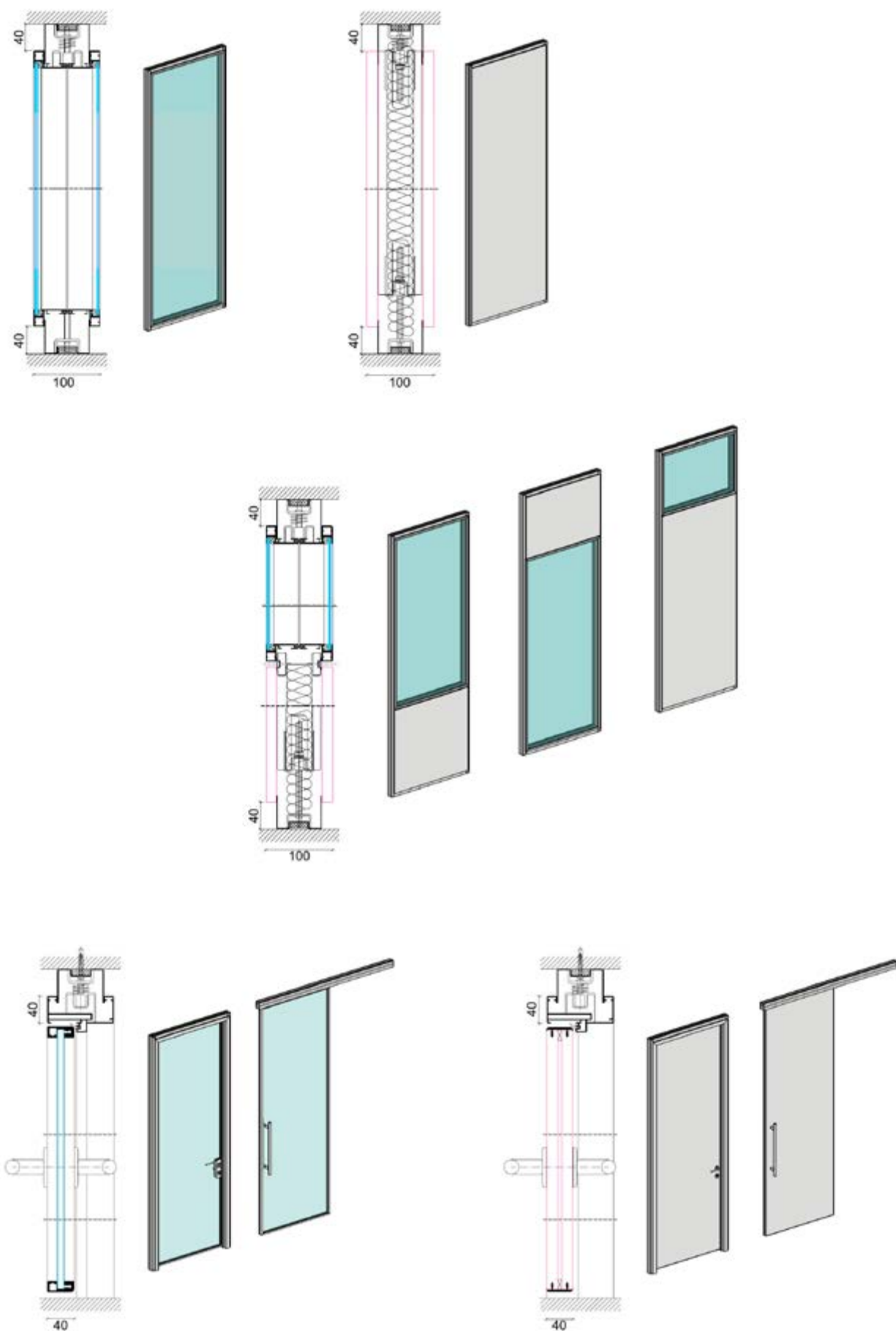

Caratteristiche tecniche - Technical features

PANNELLI

Spessore 100 mm

- Doppio vetro temperato 4 mm con assorbimento acustico di 35 dB
- Doppio pannello melaminico 19 mm con assorbimento acustico di 36 dB con inserimento di lana di roccia

PANELLING

Thickness 100 mm

- Double 4 mm tempered glazing with 35 dB sound absorption
- Double melamine panel 19 mm with 36 dB sound absorption with mineral wool insertion

PORTE

Spessore 40 mm

- Vetro temperato 10 mm
- Doppio pannello melaminico 19 mm

DOORS

Thickness 40 mm

- 10 mm tempered glazing
- Double melamine panel 19 mm

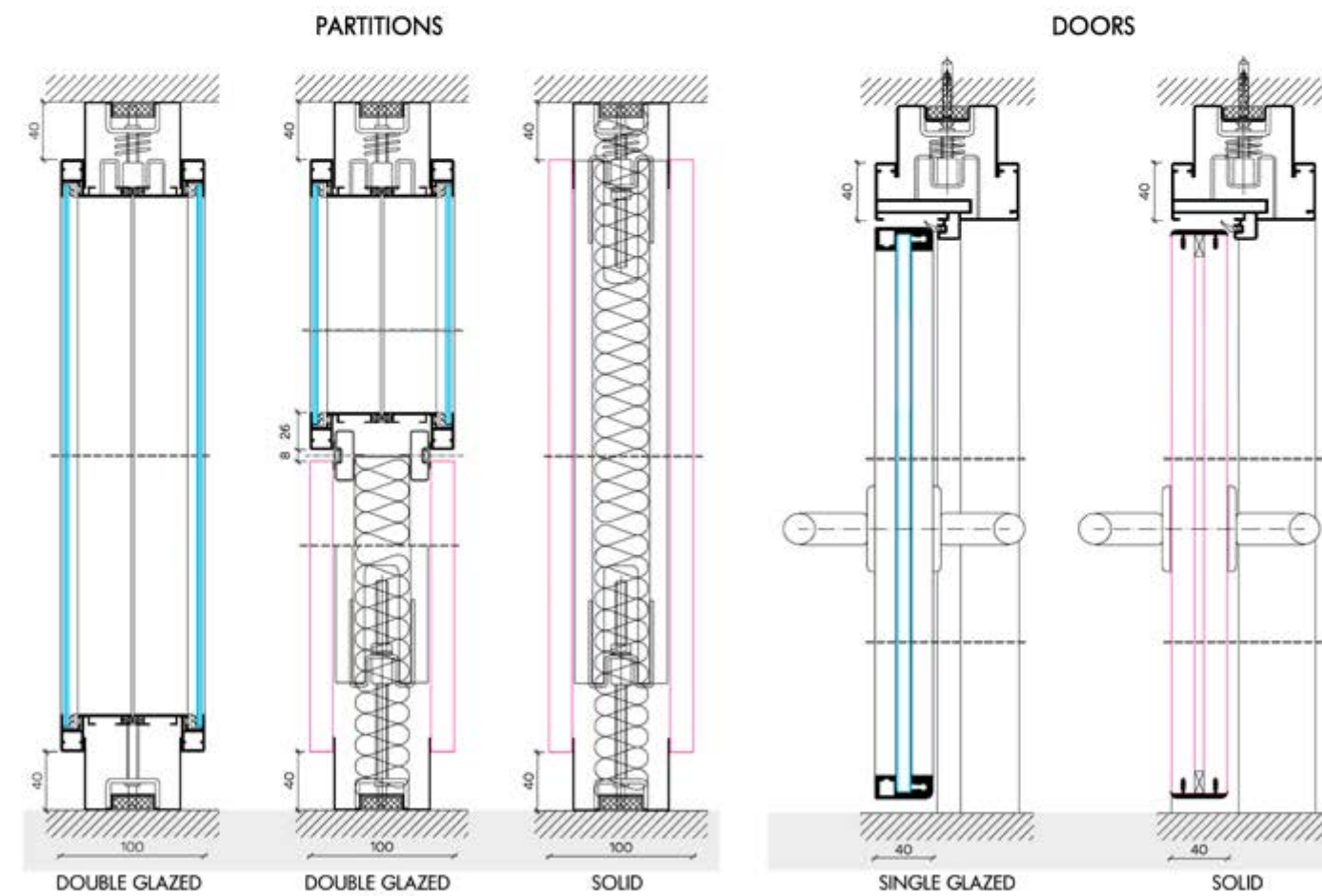

HUNDRED - Parete divisoria - Partition wall



Modulo di parete divisoria vetrata con spessore 10 cm e altezza variabile da 240 a 320 cm. Doppio vetro temperato 4 mm trasparente o sabbato. Profili in alluminio anodizzato naturale o verniciati bianchi (RAL 9010) o neri (RAL 9005).
10 cm thick glazed partition wall module with variable height from 240 to 320 cm. Double tempered glazing 4 mm clear or sandblasted. Profiles in natural anodized aluminum or painted white (RAL 9010) or black (RAL 9005).

Code	Price €/sqm
ZYHUNDREDDIV1000	553,00
Vetro trasparente - Clear glass	
ZYHUNDREDDIV1001	700,00
Vetro sabbato - Sandblasted glass	



Modulo di parete divisoria cieca con spessore 10 cm e altezza variabile da 240 a 320 cm. Doppio pannello melaminico. Profili in alluminio anodizzato naturale o verniciati bianchi (RAL 9010) o neri (RAL 9005).
10 cm thick solid partition wall module with variable height from 240 to 320 cm. Double melamine coated panel. Profiles in natural anodized aluminum or painted white (RAL 9010) or black (RAL 9005).

Code	Price €/sqm
ZYHUNDREDDIV1002	308,00

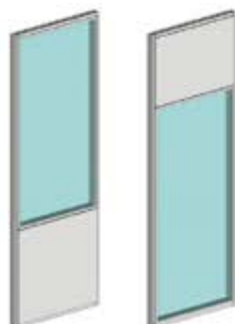

Modulo di parete divisoria combinata vetro-cieca con spessore 10 cm e altezza variabile da 240 a 320 cm. Doppio vetro temperato 4 mm trasparente o sabbato con porzione di 1/3 superiore o inferiore in doppio pannello melaminico. Profili in alluminio anodizzato naturale o verniciati bianchi (RAL 9010) o neri (RAL 9005).
10 cm thick partition wall module combined glazed and solid with variable height from 240 to 320 cm. Double tempered glazing 4 mm clear or sandblasted with 1/3 upper or lower portion in double melamine coated panel. Profiles in natural anodized aluminum or painted white (RAL 9010) or black (RAL 9005).

Code	Price €/sqm
ZYHUNDREDDIV1003	539,00
Vetro trasparente - Clear glass	
ZYHUNDREDDIV1004	637,00
Vetro sabbato - Sandblasted glass	



Modulo di parete divisoria combinata vetro-cieca con spessore 10 cm e altezza variabile da 240 a 320 cm. Doppio pannello melaminico con porzione superiore di 1/3 in doppio vetro temperato 4mm trasparente o sabbato. Profili in alluminio anodizzato naturale o verniciati bianchi (RAL 9010) o neri (RAL 9005).
10 cm thick partition wall module combined glazed and solid with variable height from 240 to 320 cm. Double melamine coated panel with 1/3 upper portion in double tempered glazing 4 mm clear or sandblasted. Profiles in natural anodized aluminum or painted white (RAL 9010) or black (RAL 9005).

Code	Price €/sqm
ZYHUNDREDDIV1005	483,00
Vetro trasparente - Clear glass	
ZYHUNDREDDIV1006	532,00
Vetro sabbato - Sandblasted glass	

HUNDRED - Parete divisoria - Partition wall



Modulo porta vetrata a battente intelaiata con spessore 4 cm larghezza 90 cm e altezza variabile da 220 a 270 cm. Vetro temperato 10 mm trasparente o sabbato. Profili in alluminio anodizzato naturale o verniciati bianchi (RAL 9010) o neri (RAL 9005). Maniglia inclusa.
Hinged glazed framed door module with a thickness of 4 cm, width 90 cm and variable height from 220 to 270 cm. 10 mm tempered glazing, clear or sandblasted. Profiles in natural anodized aluminum or painted white (RAL 9010) or black (RAL 9005). Handle included.

Code	Price €/sqm
ZYHUNDREDDIV1010	3182,00
Vetro trasparente - Clear glass	
ZYHUNDREDDIV1011	3700,00
Vetro sabbato - Sandblasted glass	



Modulo porta cieca a battente intelaiata con spessore 4 cm larghezza 90 cm e altezza variabile da 220 a 270 cm. Doppio pannello melaminico. Profili in alluminio anodizzato naturale o verniciati bianchi (RAL 9010) o neri (RAL 9005). Maniglia inclusa.
Hinged framed solid door module with a thickness of 4 cm, width 90 cm and variable height from 220 to 270 cm. Double melamine coated panel. Profiles in natural anodized aluminum or painted white (RAL 9010) or black (RAL 9005). Handle included.

Code	Price €/sqm
ZYHUNDREDDIV1012	2030,00

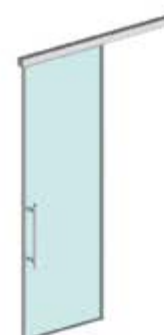

Modulo porta vetrata scorrevole intelaiata con spessore 4 cm larghezza 90 cm e altezza variabile da 220 a 270 cm. Vetro temperato 10 mm trasparente o sabbato. Profili in alluminio anodizzato naturale o verniciati bianchi (RAL 9010) o neri (RAL 9005). Maniglia h. 60 cm inclusa.
Framed glazed sliding door module with a thickness of 4 cm, width 90 cm and variable height from 220 to 270 cm. 10 mm tempered glazing, clear or sandblasted. Profiles in natural anodized aluminum or painted white (RAL 9010) or black (RAL 9005). Handle h. 60 cm included.

Code	Price €/sqm
ZYHUNDREDDIV1013	3910,00
Vetro trasparente - Clear glass	
ZYHUNDREDDIV1014	4428,00
Vetro sabbato - Sandblasted glass	



Modulo porta cieca scorrevole intelaiata con spessore 4 cm larghezza 90 cm e altezza variabile da 220 a 270 cm. Doppio pannello melaminico. Profili in alluminio anodizzato naturale o verniciati bianchi (RAL 9010) o neri (RAL 9005). Maniglia h. 60 cm inclusa.
Framed solid sliding door module with a thickness of 4 cm, width 90 cm and variable height from 220 to 270 cm. Double melamine coated panel. Profiles in natural anodized aluminum or painted white (RAL 9010) or black (RAL 9005). Handle h. 60 cm included.

Code	Price €/sqm
ZYHUNDREDDIV1015	2758,00

EIGHTY

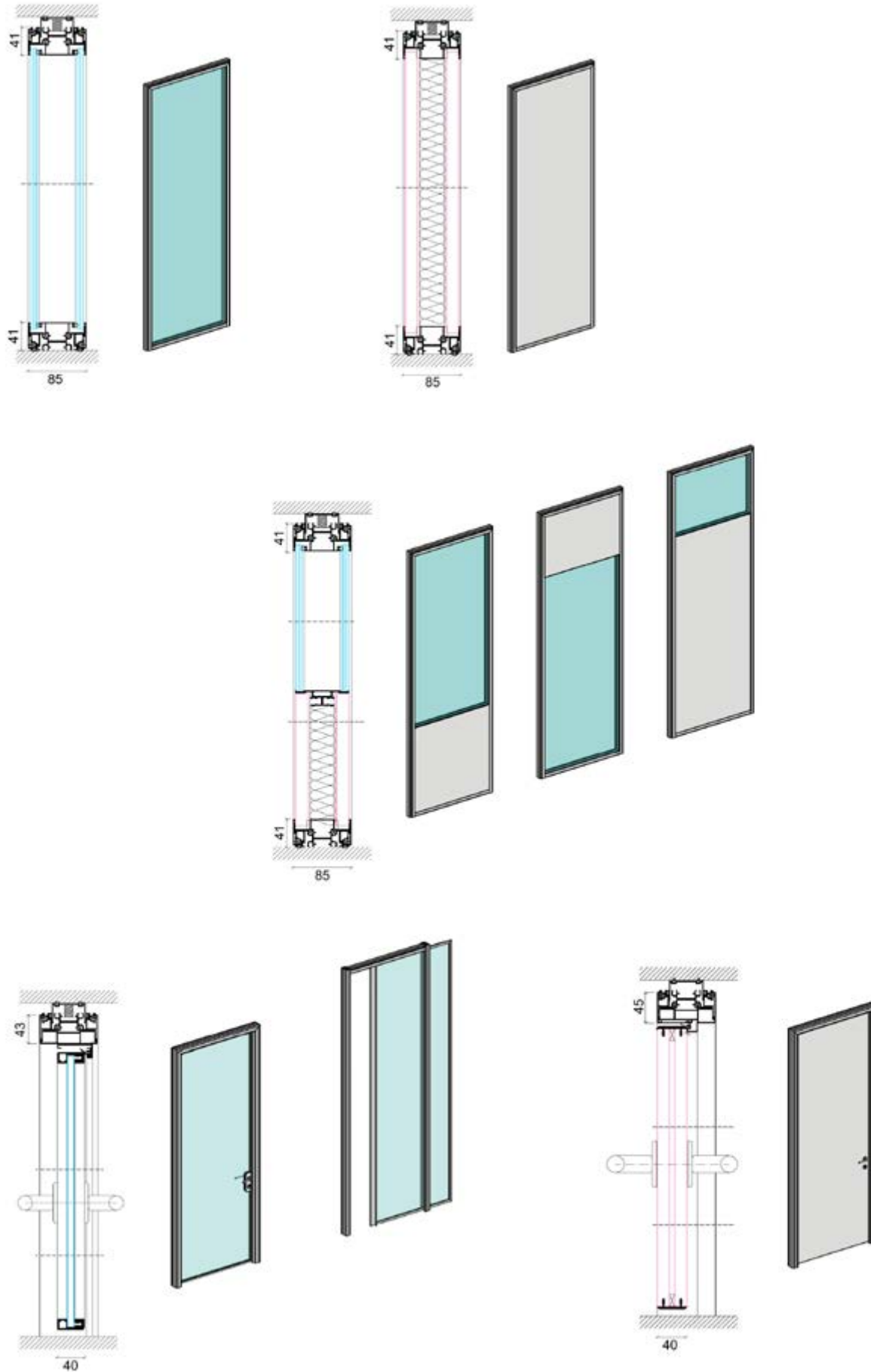

Caratteristiche tecniche - Technical features

PANNELLI

Spessore 85 mm

- Doppio vetro laminato 5+5 mm con interposto film di PVB 0,38 mm. Assorbimento acustico di 40 dB.
- Doppio vetro laminato 5+5 mm con interposto film di PVB 0,50 mm. Assorbimento acustico di 43 dB.
- Doppio pannello melaminico 19 mm con assorbimento acustico di 41 dB con inserimento di lana di roccia.

PORTE

Spessore 40 mm

- Vetro temperato 10 mm per la porta a battente; vetro laminato 5+5 con interposto film PVB da 0,38 mm per la porta scorrevole.
- Doppio pannello melaminico 19 mm.

PANELLING

Thickness 85 mm

- Double laminated glazing 5+5 mm with 0,38 mm PVB absorbing film interposed. 40 dB sound absorption.
- Double laminated glazing 5+5 mm with 0,50 mm PVB absorbing film interposed. 43 dB sound absorption.
- Double melamine panel 19 mm with 41 dB sound absorption with mineral wool insertion.

DOORS

Thickness 40 mm

- 10 mm tempered glazing for the hinged door; 5+5 mm laminated glazing with 0.38 mm PVB absorbing film interposed for the sliding door.
- Double melamine panel 19 mm.

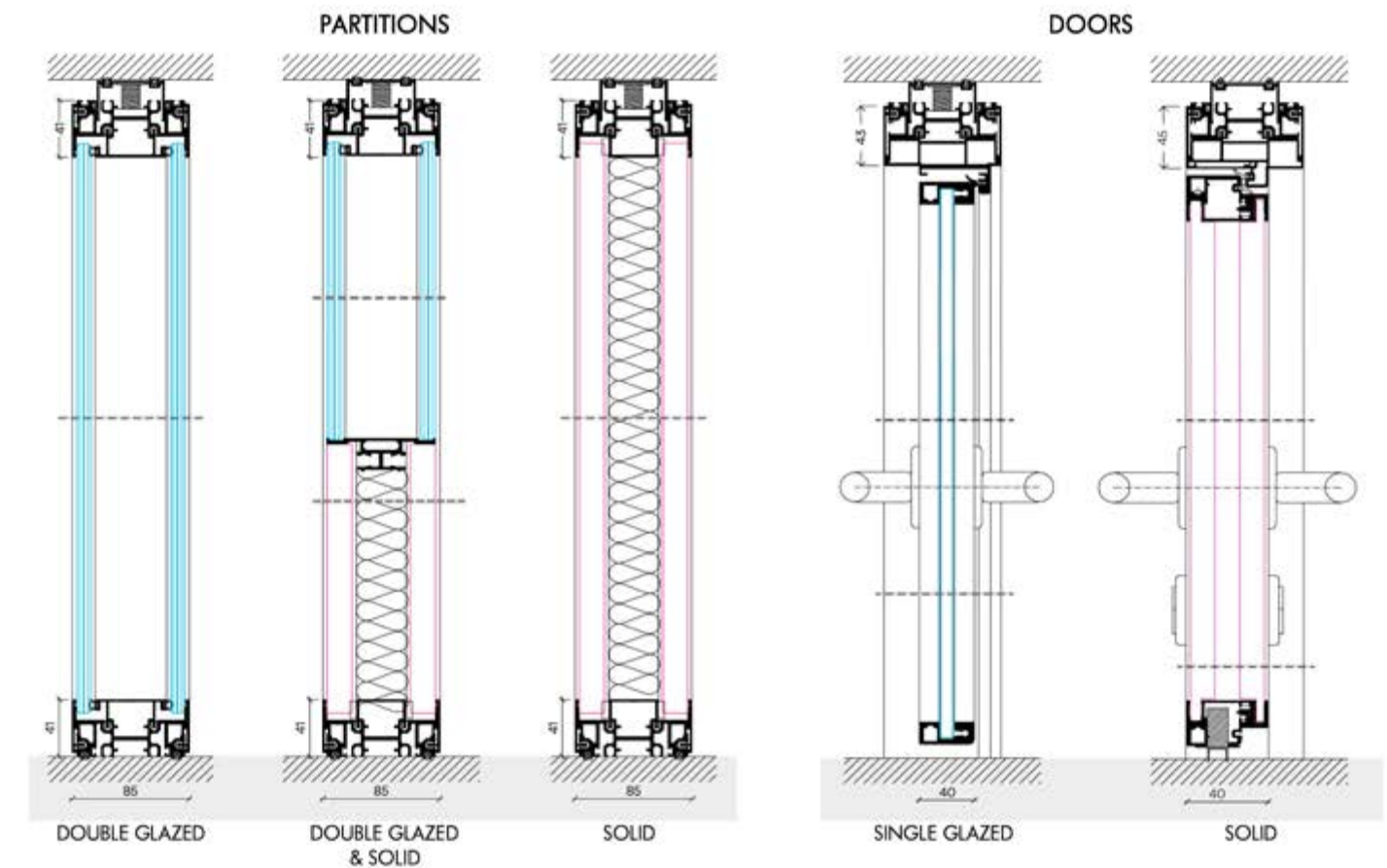

EIGHTY - Parete divisoria - Partition wall



Modulo di parete divisoria vetrata con spessore 8,5 cm e altezza variabile da 240 a 320 cm. Doppio vetro laminato 5+PVB+5 mm trasparente o sabbato. Profili in alluminio anodizzato naturale o verniciati bianchi (RAL 9010) o neri (RAL 9005). Disponibile anche con doppio vetro supersilenziato trasparente con lamina di PVB da 0,5 mm.

8,5 cm thick glazed partition wall module with variable height from 240 to 320 cm. Double laminated glazing 5+PVB+5 mm clear or sandblasted. Profiles in natural anodized aluminum or painted white (RAL 9010) or black (RAL 9005). Also available with clear super-silenced laminated double glazed with 0.5 mm PVB sheet.

Code	Price €/sqm
ZYEIGHTYDIV2000	529,00
Vetro trasparente - Clear glass	
ZYEIGHTYDIV2001	697,00
Vetro sabbato - Sandblasted glass	
ZYEIGHTYDIV2002	578,00
Vetro trasparente supersilenziato - Clear super-silenced glass	



Modulo di parete divisoria cieca con spessore 8,5 cm e altezza variabile da 240 a 320 cm. Doppio pannello melaminico. Profili in alluminio anodizzato naturale o verniciati bianchi (RAL 9010) o neri (RAL 9005).

8,5 cm thick solid partition wall module with variable height from 240 to 320 cm. Double melamine coated panel. Profiles in natural anodized aluminum or painted white (RAL 9010) or black (RAL 9005).

Code	Price €/sqm
ZYEIGHTYDIV2003	347,00

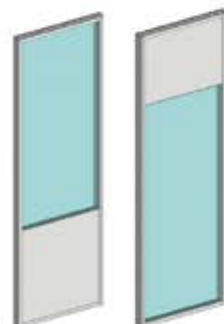

Modulo di parete divisoria combinata vetro-cieca con spessore 8,5 cm e altezza variabile da 240 a 320 cm. Doppio vetro laminato 5+PVB+5 mm trasparente o sabbato con porzione di 1/3 superiore o inferiore in doppio pannello melaminico. Profili in alluminio anodizzato naturale o verniciati bianchi (RAL 9010) o neri (RAL 9005). Disponibile anche con doppio vetro supersilenziato trasparente con lamina di PVB da 0,5 mm.

8,5 cm thick partition wall module combined glazed and solid with variable height from 240 to 320 cm. Double laminated glazing 5+PVB+5 mm clear or sandblasted with 1/3 upper or lower portion in double melamine coated panel. Profiles in natural anodized aluminum or painted white (RAL 9010) or black (RAL 9005). Also available with clear super-silenced laminated double glazed with 0.5 mm PVB sheet.

Code	Price €/sqm
ZYEIGHTYDIV2004	466,00
Vetro trasparente - Clear glass	
ZYEIGHTYDIV2005	578,00
Vetro sabbato - Sandblasted glass	
ZYEIGHTYDIV2006	501,00
Vetro trasparente supersilenziato - Clear super-silenced glass	

EIGHTY - Parete divisoria - Partition wall



Modulo di parete divisoria combinata vetro-cieca con spessore 8,5 cm e altezza variabile da 240 a 320 cm. Doppio pannello melaminico con porzione superiore di 1/3 in doppio vetro laminato 5+PVB+5 mm trasparente o sabbato. Profili in alluminio anodizzato naturale o verniciati bianchi (RAL 9010) o neri (RAL 9005). Disponibile anche con doppio vetro supersilenziato trasparente con lamina di PVB da 0,5 mm.

8,5 cm thick partition wall module combined glazed and solid with variable height from 240 to 320 cm. Double melamine coated panel with 1/3 upper portion in double laminated glazing 5+PVB+5 mm clear or sandblasted. Profiles in natural anodized aluminum or painted white (RAL 9010) or black (RAL 9005). Also available with clear super-silenced laminated double glazed with 0.5 mm PVB sheet.

Code	Price €/sqm
ZYEIGHTYDIV2007	406,00
Vetro trasparente - Clear glass	
ZYEIGHTYDIV2008	462,00
Vetro sabbato - Sandblasted glass	
ZYEIGHTYDIV2009	424,00
Vetro trasparente supersilenziato - Clear super-silenced glass	



Modulo porta a battente vetrata intelaiata con spessore 4 cm larghezza 90 cm e altezza variabile da 220 a 270 cm. Vetro temperato 10 mm trasparente o sabbato. Profili in alluminio anodizzato naturale o verniciati bianchi (RAL 9010) o neri (RAL 9005). Maniglia inclusa.

Hinged framed glazed door module with a thickness of 4 cm, width 90 cm and variable height from 220 to 270 cm. 10 mm tempered glazing, clear or sandblasted. Profiles in natural anodized aluminum or painted white (RAL 9010) or black (RAL 9005). Handle included.

Code	Price €/sqm
ZYEIGHTYDIV2020	3042,00
Vetro trasparente - Clear glass	
ZYEIGHTYDIV2021	3119,00
Vetro sabbato - Sandblasted glass	



Modulo porta a battente cieca intelaiata con spessore 4 cm larghezza 90 cm e altezza variabile da 220 a 270 cm. Doppio pannello melaminico. Profili in alluminio anodizzato naturale o verniciati bianchi (RAL 9010) o neri (RAL 9005). Maniglia inclusa.

Hinged framed solid door module with a thickness of 4 cm, width 90 cm and variable height from 220 to 270 cm. Double melamine coated panel. Profiles in natural anodized aluminum or painted white (RAL 9010) or black (RAL 9005). Handle included.

Code	Price €/sqm
ZYEIGHTYDIV2022	1729,00

EIGHTY - Parete divisoria - Partition wall

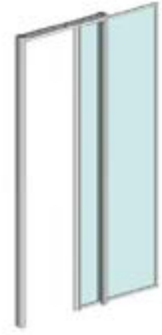

Modulo porta scorrevole vetrata intelaiata a scorrimento interno con spessore 2 cm larghezza 90 cm e altezza variabile da 220 a 270 cm. Vetro laminato 5+PVB+5 mm trasparente o sabbato. Profili in alluminio anodizzato naturale o verniciati bianchi (RAL 9010) o neri (RAL 9005). Maniglia a tutta altezza integrata nel profilo.

Framed glazed internal sliding door module with a thickness of 2 cm, width 90 cm and variable height from 220 to 270 cm. 5+PVB+5 mm laminated glazing, clear or sandblasted. Profiles in natural anodized aluminum or painted white (RAL 9010) or black (RAL 9005). Integrated vertical full-height handle.

Code	Price €/sqm
ZYEIGHTYDIV2023	3784,00
Vetro trasparente - Clear glass	
ZYEIGHTYDIV2024	3861,00
Vetro sabbato - Sandblasted glass	

FIFTY

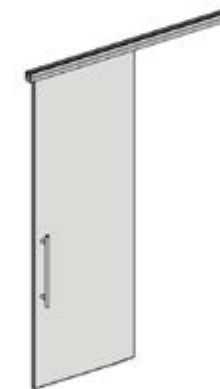
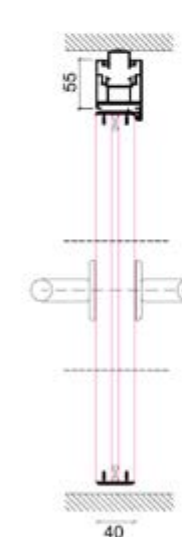
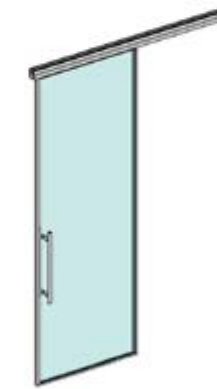
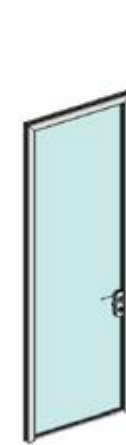
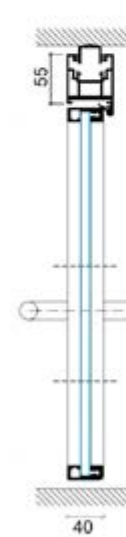
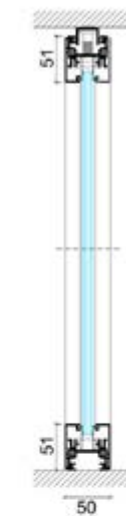

Caratteristiche tecniche - Technical features

PANNELLI

Spessore 50 mm

- Singolo o doppio vetro laminato 5+5 mm con interposto film di PVB 0,38 mm. Assorbimento acustico di 33-40 dB.
- Singolo o doppio vetro laminato 5+5 mm con interposto film di PVB 0,50 mm. Assorbimento acustico di 37-42 dB.
- Doppio pannello melaminico 19 mm con assorbimento acustico di 43 dB con inserimento di lana di roccia.

PORTE

Spessore 40 mm

- Vetro temperato 10 mm.
- Doppio pannello melaminico 19 mm.

PANELLING

Thickness 50 mm

- Single or double laminated glazing 5+5 mm with 0,38 mm PVB absorbing film interposed. 33-40 dB sound absorption.
- Single or double laminated glazing 5+5 mm with 0,50 mm PVB absorbing film interposed. 37-42 dB sound absorption.
- Double melamine panel 19 mm with 43 dB sound absorption with mineral wool insertion.

DOORS

Thickness 40 mm

- 10 mm tempered glazing.
- Double melamine panel 19 mm.

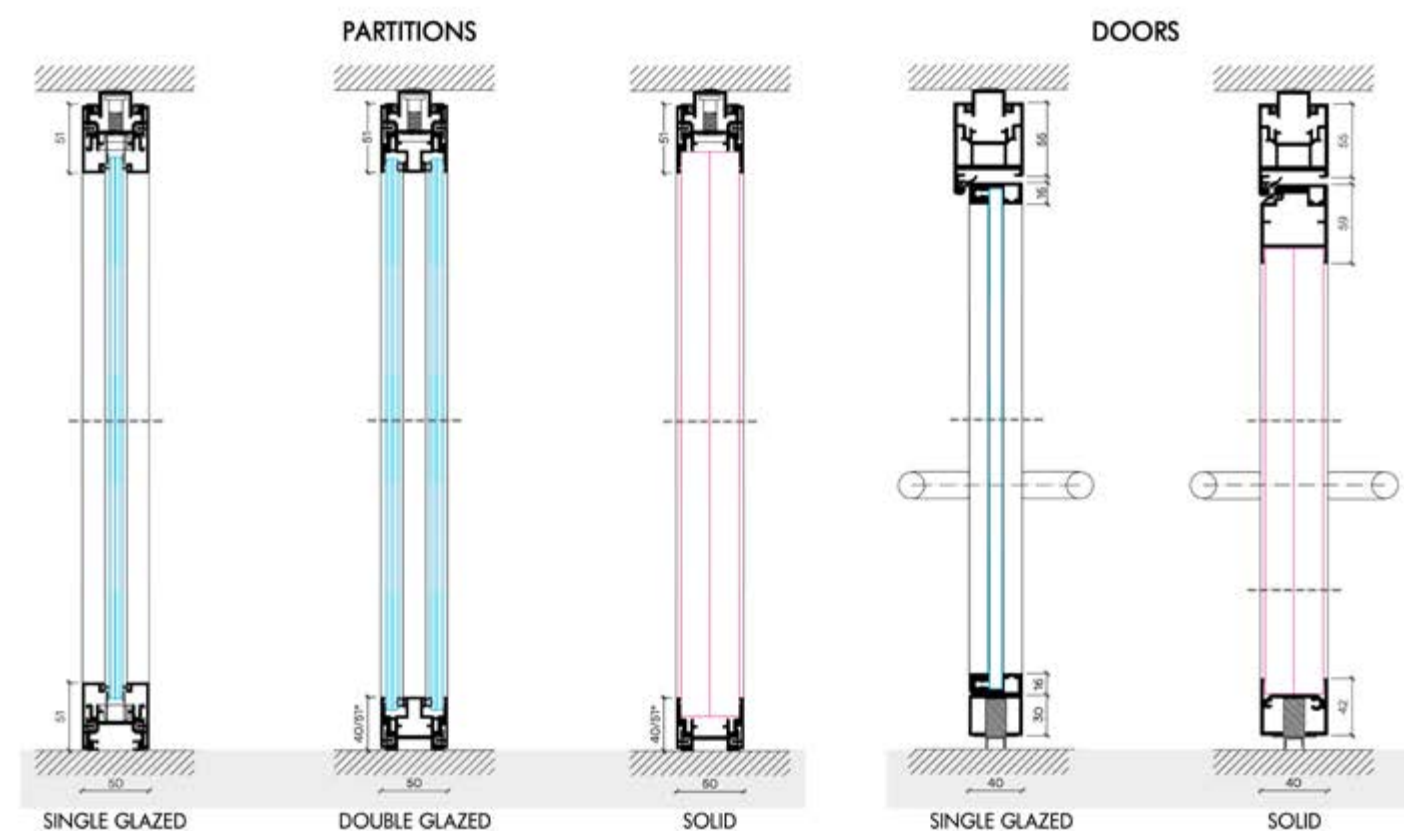

FIFTY - Parete divisoria - Partition wall



Modulo di parete divisoria vetrata con spessore 5 cm e altezza variabile da 240 a 320 cm. Doppio vetro laminato 5+PVB+5 mm trasparente o sabbato. Profili in alluminio anodizzato naturale o verniciati bianchi (RAL 9010) o neri (RAL 9005). Disponibile anche con doppio vetro supersilenziato trasparente con lamina di PVB da 0,5 mm.
5 cm thick glazed partition wall module with variable height from 240 to 320 cm. Double laminated glazing 5+PVB+5 mm clear or sandblasted. Profiles in natural anodized aluminum or painted white (RAL 9010) or black (RAL 9005). Also available with clear super-silenced laminated double glazed with 0.5 mm PVB sheet.

Code	Price €/sqm
ZYFIFTYDIV3000	483,00
Vetro trasparente - Clear glass	
ZYFIFTYDIV3001	651,00
Vetro sabbato - Sandblasted glass	
ZYFIFTYDIV3002	532,00
Vetro trasparente supersilenziato - Clear super-silenced glass	



Modulo di parete divisoria vetrata con spessore 5 cm e altezza variabile da 240 a 320 cm. Singolo vetro laminato 5+PVB+5 mm trasparente o sabbato. Profili in alluminio anodizzato naturale o verniciati bianchi (RAL 9010) o neri (RAL 9005). Disponibile anche con singolo vetro supersilenziato trasparente con lamina di PVB da 0,5 mm.
5 cm thick glazed partition wall module with variable height from 240 to 320 cm. Single laminated glazing 5+PVB+5 mm clear or sandblasted. Profiles in natural anodized aluminum or painted white (RAL 9010) or black (RAL 9005). Also available with clear super-silenced laminated single glazed with 0.5 mm PVB sheet.

Code	Price €/sqm
ZYFIFTYDIV3003	347,00
Vetro trasparente - Clear glass	
ZYFIFTYDIV3004	431,00
Vetro sabbato - Sandblasted glass	
ZYFIFTYDIV3005	371,00
Vetro trasparente supersilenziato - Clear super-silenced glass	



Modulo di parete divisoria cieca con spessore 5 cm e altezza variabile da 240 a 320 cm. Doppio pannello melaminico. Profili in alluminio anodizzato naturale o verniciati bianchi (RAL 9010) o neri (RAL 9005).
5 cm thick solid partition wall module with variable height from 240 to 320 cm. Double melamine coated panel. Profiles in natural anodized aluminum or painted white (RAL 9010) or black (RAL 9005).

Code	Price €/sqm
ZYFIFTYDIV3006	308,00

FIFTY - Parete divisoria - Partition wall



Modulo porta a battente vetrata intelaiata con spessore 4 cm larghezza 90 cm e altezza variabile da 220 a 270 cm. Vetro temperato 10 mm trasparente o sabbato. Profili in alluminio anodizzato naturale o verniciati bianchi (RAL 9010) o neri (RAL 9005). Maniglia inclusa.

Hinged framed glazed door module with a thickness of 4 cm, width 90 cm and variable height from 220 to 270 cm. 10 mm tempered glazing, clear or sandblasted. Profiles in natural anodized aluminum or painted white (RAL 9010) or black (RAL 9005). Handle included.

Code	Price €/sqm
ZYFIFTYDIV3010	2622,00
Vetro trasparente - Clear glass	
ZYFIFTYDIV3011	2699,00
Vetro sabbato - Sandblasted glass	



Modulo porta a battente cieca intelaiata con spessore 4 cm larghezza 90 cm e altezza variabile da 220 a 270 cm. Doppio pannello melaminico. Profili in alluminio anodizzato naturale o verniciati bianchi (RAL 9010) o neri (RAL 9005). Maniglia inclusa.

Hinged framed solid door module with a thickness of 4 cm, width 90 cm and variable height from 220 to 270 cm. Double melamine coated panel. Profiles in natural anodized aluminum or painted white (RAL 9010) or black (RAL 9005). Handle included.

Code	Price €/sqm
ZYFIFTYDIV3012	1824,00

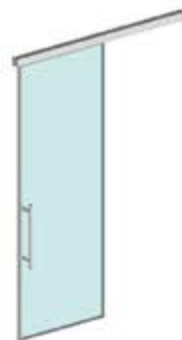

Modulo porta scorrevole vetrata intelaiata con spessore 4 cm larghezza 90 cm e altezza variabile da 220 a 270 cm. Vetro temperato 10 mm trasparente o sabbato. Profili in alluminio anodizzato naturale o verniciati bianchi (RAL 9010) o neri (RAL 9005). Maniglia h. 60 cm inclusa.

Framed glazed sliding door module with a thickness of 4 cm, width 90 cm and variable height from 220 to 270 cm. 10 mm tempered glazing, clear or sandblasted. Profiles in natural anodized aluminum or painted white (RAL 9010) or black (RAL 9005). Handle h. 60 cm included.

Code	Price €/sqm
ZYFIFTYDIV3013	3353,00
Vetro trasparente - Clear glass	
ZYFIFTYDIV3014	3430,00
Vetro sabbato - Sandblasted glass	



Modulo porta scorrevole cieca intelaiata con spessore 4 cm larghezza 90 cm e altezza variabile da 220 a 270 cm. Doppio pannello melaminico. Profili in alluminio anodizzato naturale o verniciati bianchi (RAL 9010) o neri (RAL 9005). Maniglia h. 60 cm inclusa.

Framed solid sliding door module with a thickness of 4 cm, width 90 cm and variable height from 220 to 270 cm. Double melamine coated panel. Profiles in natural anodized aluminum or painted white (RAL 9010) or black (RAL 9005). Handle h. 60 cm included.

Code	Price €/sqm
ZYFIFTYDIV3015	3241,00

TWENTY

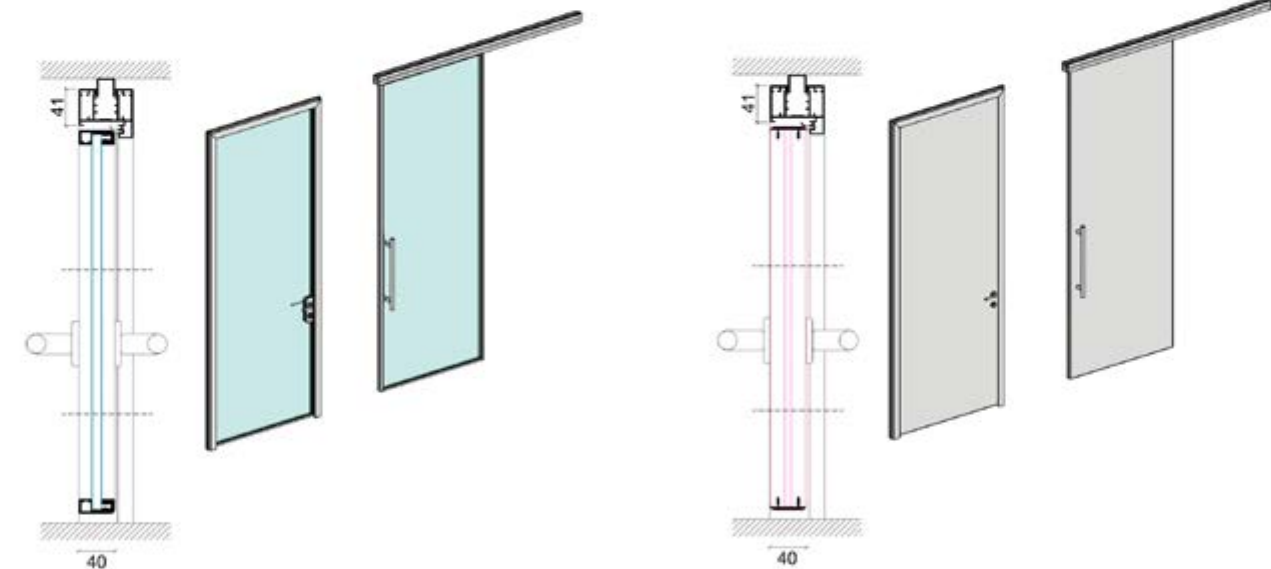
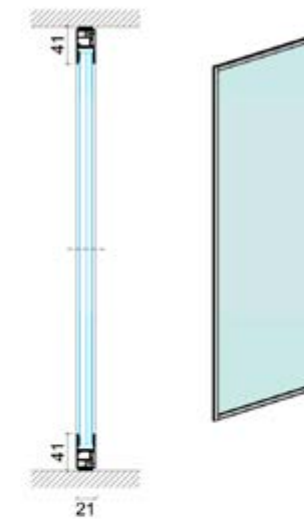

Caratteristiche tecniche - Technical features

PANNELLI

Spessore 21 mm

- Singolo vetro laminato 6+8 mm con interposto film di PVB 0,38 mm. Assorbimento acustico di 40 dB.

PORTE

Spessore 40 mm

- Vetro temperato 10 mm.
- Doppio pannello melaminico 19 mm.

PANELLING

Thickness 21 mm

- Single laminated glazing 6+8 mm with 0,38 mm PVB absorbing film interposed. 40 dB sound absorption.

DOORS

Thickness 40 mm

- 10 mm tempered glazing.
- Double melamine panel 19 mm.

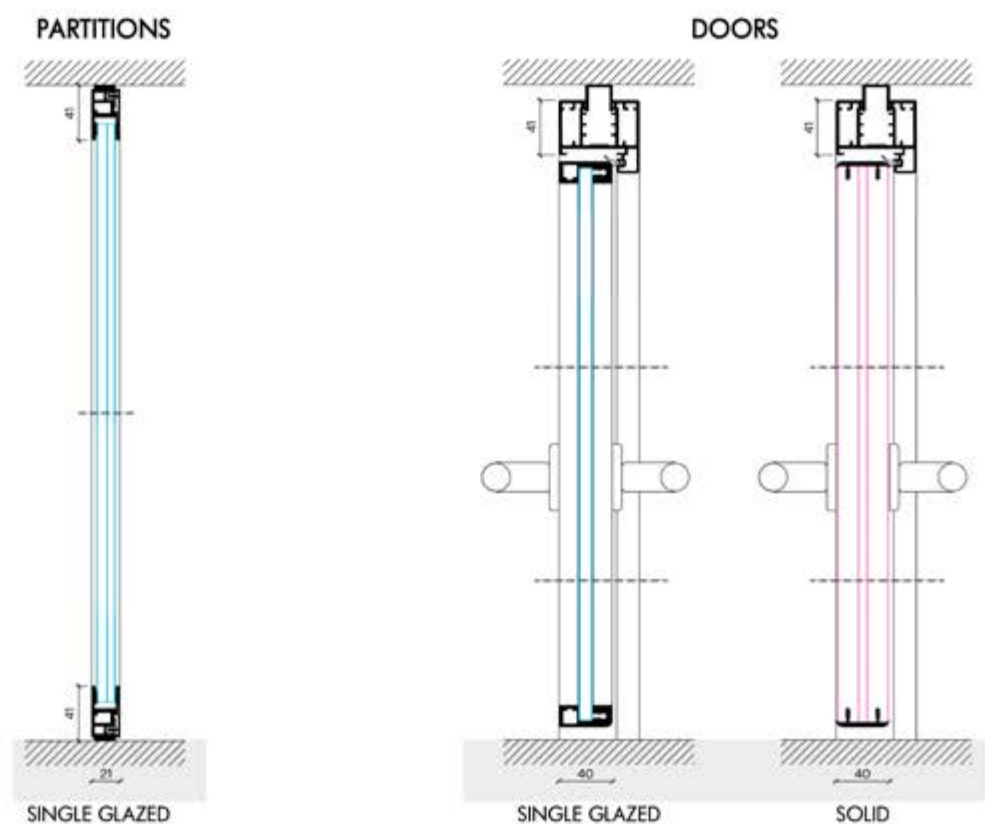

TWENTY - Parete divisoria - Partition wall



Modulo di parete divisoria vetrata con spessore 2,1 cm e altezza variabile da 240 a 320 cm. Singolo vetro laminato 6+PVB+8 mm trasparente o sabbato. Profili in alluminio anodizzato naturale o verniciati bianchi (RAL 9010) o neri (RAL 9005).
2,1 cm thick glazed partition wall module with variable height from 240 to 320 cm. Single laminated glazing 6+PVB+8 mm clear or sandblasted. Profiles in natural anodized aluminum or painted white (RAL 9010) or black (RAL 9005).

Code	Price €/sqm
ZYTWENTYDIV4000	354,00
Vetro trasparente - Clear glass	
ZYTWENTYDIV4001	539,00
Vetro sabbato - Sandblasted glass	
ZYTWENTYDIV4002	434,00
Vetro trasparente supersilenziato - Clear super-silenced glass	



Modulo porta a battente vetrata intelaiata con spessore 4 cm larghezza 90 cm e altezza variabile da 220 a 270 cm. Vetro temperato 10 mm trasparente o sabbato. Profili in alluminio anodizzato naturale o verniciati bianchi (RAL 9010) o neri (RAL 9005). Maniglia inclusa.
Hinged glazed framed door module with a thickness of 4 cm, width 90 cm and variable height from 220 to 270 cm. 10 mm tempered glazing, clear or sandblasted. Profiles in natural anodized aluminum or painted white (RAL 9010) or black (RAL 9005). Handle included.

Code	Price €/sqm
ZYTWENTYDIV4010	2468,00
Vetro trasparente - Clear glass	
ZYTWENTYDIV4011	2545,00
Vetro sabbato - Sandblasted glass	



Modulo porta a battente cieca intelaiata con spessore 4 cm larghezza 90 cm e altezza variabile da 220 a 270 cm. Doppio pannello melaminico. Profili in alluminio anodizzato naturale o verniciati bianchi (RAL 9010) o neri (RAL 9005). Maniglia inclusa.
Hinged framed solid door module with a thickness of 4 cm, width 90 cm and variable height from 220 to 270 cm. Double melamine coated panel. Profiles in natural anodized aluminum or painted white (RAL 9010) or black (RAL 9005). Handle included.

Code	Price €/sqm
ZYTWENTYDIV4012	1642,00

TWENTY - Parete divisoria - Partition wall

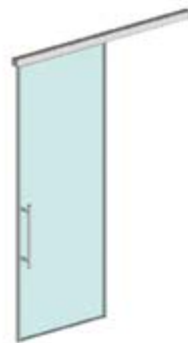

Modulo porta scorrevole vetrata intelaiata con spessore 4 cm larghezza 90 cm e altezza variabile da 220 a 270 cm. Vetro temperato 10 mm trasparente o sabbciato. Profili in alluminio anodizzato naturale o verniciati bianchi (RAL 9010) o neri (RAL 9005). Maniglia h. 60 cm inclusa.

Framed glazed sliding door module with a thickness of 4 cm, width 90 cm and variable height from 220 to 270 cm. 10 mm tempered glazing, clear or sandblasted. Profiles in natural anodized aluminum or painted white (RAL 9010) or black (RAL 9005). Handle h. 60 cm included.

Code	Price €/sqm
ZYTWENTYDIV4013	3217,00
Vetro trasparente - Clear glass	
ZYTWENTYDIV4014	3294,00
Vetro sabbciato - Sandblasted glass	

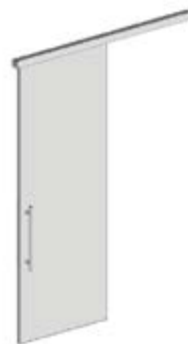

Modulo porta scorrevole cieca intelaiata con spessore 4 cm larghezza 90 cm e altezza variabile da 220 a 270 cm. Doppio pannello melaminico. Profili in alluminio anodizzato naturale o verniciati bianchi (RAL 9010) o neri (RAL 9005). Maniglia h. 60 cm inclusa.

Framed solid sliding door module with a thickness of 4 cm, width 90 cm and variable height from 220 to 270 cm. Double melamine coated panel. Profiles in natural anodized aluminum or painted white (RAL 9010) or black (RAL 9005). Handle h. 60 cm included.

Code	Price €/sqm
ZYTWENTYDIV4015	2779,00

i4MARIANI S.R.L.

VIA S. ANTONIO 102/104
22066 MARIANO COMENSE
COMO, ITALY
PH +39 031 746204
FAX +39 031 749060
INFO@I4MARIANI.IT
WWW.I4MARIANI.COM

La descrizione e le immagini dei prodotti del presente catalogo sono puramente indicative e non possono essere considerate vincolati ai fini del loro utilizzo. i4Mariani si riserva di apportare ai prodotti le modifiche che ritiene più opportune, in qualsiasi momento e senza preavviso. Per ulteriori informazioni invitiamo a consultare il sito www.i4mariani.com

Descriptions and pictures of products included in this catalogue have an indicative value only and are not binding for products' use. i4Mariani reserves the right to modify their products without prior notification. For further technical information of the products, please go and see www.i4mariani.com

