



Quadrifoglio Group

Pricelist 2023

Residential & Hospitality Collection

design living



YOUR SPACE PLANNER

Founded in 1991, Quadrifoglio Group designs and manufactures office furniture, seating, partition wall, lighting and accessories. The company works closely with Designers and Planners who care about workplace wellbeing, finding innovative solutions that combine aesthetics and design, maintain environmental corporate sustainability, and give comprehensive assistance to the quality of our products.

HEADQUARTERS AND TECHNOLOGY

Our main office, plant and warehouse are based in Northeast Italy within one of the largest furniture industrial clusters in Europe. We aim at providing our clients with design-led products in line with the internationally renowned tendency of the Italians toward style and design. The company operates from a 35.000 sqm modern and clean manufacturing plant. Thanks to efficient automated machinery and equipment all processes from manufacturing through to packaging and warehousing achieve outstanding performance.

QUALITY, ENVIRONMENT, HEALTH AND SAFETY

The company is always looking for quality and respect for the environment in all of its production processes. Today Quadrifoglio Sistemi d'Arredo is ISO 9001:2015, ISO 14001:2015, ISO 45001:2018 as well as FSC™ certified and Ecological Panel.

COMPANY WITH
MANAGEMENT SYSTEM
CERTIFIED BY DNV
ISO 9001 • ISO 14001
ISO 45001



TOTAL CUSTOMER SATISFACTION

Our main goal is to achieve full Customer Satisfaction by providing high quality products with the best service. Quadrifoglio Group aims to help and support clients thanks to:

1. pre/after-sales service
2. expertise of in-house architects and designers
3. stock availability
4. sales literature and product images

1. PRE/AFTER-SALES SERVICE

Quadrifoglio Group looks forward to building a long term business relation with clients based on trust and active listening. Our technical and customer care offices as well as the sales teams are delighted to assist with providing solutions, product specs, pricing, small visuals.

2. EXPERTISE OF IN-HOUSE ARCHITECTS AND DESIGNERS

We provide 2D/3D product libraries in the format of Autocad files to help clients create their visual. Furthermore we can offer a free license to pCon a Cad-based user-friendly space planning program inclusive of our full 3D libraries. Our in-house architects and designers are available to help clients with space planning and visuals.



3. STOCK AVAILABILITY

We are aware that fast delivery is a key factor in today's market, hence our policy to hold permanent stock of a very large part of the product portfolio. Barcode-based technology helps material handling and product tracking. All parcels are accurately packaged using polystyrene, bubble wrap, flexible packaging film, cardboard and are labelled to provide detailed information. Products are delivered flat packed (except for pedestals) and include a printed user-friendly assembly instruction sheet.

4. SALES LITERATURE AND PRODUCT IMAGES

Quadrifoglio Group provides sales literature both in electronic and printed form, catalogue images, finish samples, specification sheets, certifications,... You can download directly from our www.quadrifoglio.com website



VOTRE PARTENAIRE

Depuis 1991 Quadrifoglio Group se consacre à la fabrication et au design de mobiliers, de cloisons de partition et de produits pour l'éclairage de bureaux. La qualité de notre production, qui est 100% italienne, assure un produit très qualitatif, ainsi qu'une solution d'aménagement de bureau complète capable de améliorer l'efficacité et le bien-être individuel.

SIEGE ET TECHNOLOGIE

Notre usine et entrepôt sont localisés au nord-est de l'Italie et grâce à nos partenaires nous sommes présents désormais dans tout le monde. Avec un site industriel de 35.000 m², qui est équipé d'outils performants et de spécialisées, Quadrifoglio Group optimise toujours la fabrication, l'emballage et le stockage de ses produits.

QUALITE, ENVIRONNEMENT, SANTE ET SÛRETE

Notre société prête attention aux thèmes de la qualité et de l'environnement durable, pour pouvoir fournir des produits et un service conforme aux requêtes de nos clients. Nous nous focalisons sur le système de gestion de la santé et sécurité de nos employés. Pour ça nous sommes certifiés ISO 9001:2015, ISO 14001:2015, ISO 45001:2018, FSC™ et le Panneau Ecologique.

COMPANY WITH
MANAGEMENT SYSTEM
CERTIFIED BY DNV
ISO 9001 • ISO 14001
ISO 45001



SATISFACTION TOTALE

Notre objectif principal est de satisfaire nos clients en ce qui concerne la qualité des produits, ainsi que le service donné. Quadrifoglio Group s'engage à soutenir ses partenaires en prenant le temps pour les écouter et en essayant de réaliser tous leur projets à l'aide de:

1. service avant et après-vente
2. consultation avec designers et architectes
3. disponibilité du stock et logistique rapide
4. documentation

1. SERVICE AVANT ET APRES-VENTE

Quadrifoglio Group s'engage à établir une collaboration durable avec ses partenaires, qui se base sur la confiance des uns vers les autres. Tous nos investissements sont étudiés pour assurer un service complet et ponctuel, ainsi que efficace et efficient. Pour cette raison, nos techniciens, notre service clients et nos commerciaux sont à Votre disposition pour vous tenir au courant sur la production et pour vous assurer une assistance adéquate pendant l'élaboration des offres et des commandes.

2. COMPETENCE DES DESIGNERS ET DES ARCHITECTES

Nous mettons à votre disposition les meilleurs instruments graphiques 2D et 3D, pour créer des concepts graphiques des espaces de travail réalisables. La collection complète de nos produits peut être téléchargée et intégrée dans les projets réalisés avec PCON. Ce logiciel permet de créer des espaces virtuels complexes, des render en 2D et 3D, des vues en perspective/isométriques ou planimétriques, ainsi que de voir les détails et les prix de chaque article dessiné. Possibilité d'importer des plans en AUTOCAD avec une large collection d'objets pour compléter et rendre réelles vos implantations.



AUTODESK
AUTOCAD

3. DISPONIBILITE EN STOCK ET LOGISTIQUE

Etant conscients de la nécessité d'être toujours performants pour satisfaire les exigences du marché international, la plupart de nos produits est disponible en stock. Tous les colis sont marqués par des étiquettes descriptives avec la référence du client, et sont protégés par polystyrène, film thermo-rétractable et carton. La marchandise est livrée démontée et il y toujours d'efficaces notices de montage dans les mêmes emballages. Quadrifoglio Group assure des livraisons rapides et ponctuelles utilisant des transporteurs fiables. De plus, la gestion informatisée vous assure l'envoi de lettres de voitures et à la fois d'avis de livraison de la marchandise.

4. DOCUMENTATION

Quadrifoglio Group donne à ses partenaires des informations techniques concernant ses produits, ainsi que du matériel au support commercial, comme par exemple nos catalogues, nos brochures, les certifications de la société et les rendering/implantations pour toutes les bibliothèques Autocad. Tout cela peut être téléchargé en cliquant sur www.quadrifoglio.com



IHR PARTNER LIEFERANT

Seit 1991 widmet Quadrifoglio Group der Herstellung und Entwicklung von Büromöbel, Sitzmöbeln, Trennwandsystemen und Beleuchtung 100% Made in Italy. Wir entwickeln, planen, produzieren und liefern Arbeitswelten auf die Bedürfnisse der Mitarbeiter inspiriert. Dabei steht für uns immer der Nutzer mit seinen Anforderungen im Mittelpunkt.

TECHNOLOGIE

Unsere Werke sitzen sich in der schönen italienischen Mitte der Möbelbranche. Firmenanlagen mit europäischen Standards, spezialisiert und ausgerichtet, mit 35.000 m² Fläche. Die Herstellungsanlage und das Lager sind bekannt für die Fähigkeiten, die allen Sicherheits-EU-Normen entsprechen. Ausgestattet mit modernen Werkzeugen, optimiert Quadrifoglio die Herstellung, das Verpacken und das Lagern der Produkte.

QUALITÄT, UMWELT, GESUNDHEIT UND SICHERHEIT

Seit jeher, gibt unsere Firma Acht auf Qualität und Umwelt, um entsprechenden Produkte und Dienst für unseren Kunden Erwartungen auszustatten. Wir konzentrieren uns besonders auf Gesundheit und Sicherheit am Arbeitsplätzen. Aus diesem Grund haben wir die folgende Zertifizierungen: ISO 9001:2015, ISO 14001:2015, ISO 45001:2018, FSC™ und Ökologische Panel.

COMPANY WITH
MANAGEMENT SYSTEM
CERTIFIED BY DNV
ISO 9001 • ISO 14001
ISO 45001



ZUFRIEDENHEIT RUNDUM

Unseres oberstes Ziel: ein um 360° zufriedener Kunde, durch an die Qualität der Produkte und das Dienst. Quadrifoglio Group widmet sich, um die Kunden zu stützen und ihren Projekten zu realisieren:

1. Kundenservice und After-Sales-Service
2. Kompetenz unserer Architekten und Designers
3. Lagerhaltigkeit und schnelle Lieferzeiten
4. Technischen Datenblätter

1. KUNDERSERVICE UND AFTER-SALES-SERVICE

Quadrifoglio Group ist entschlossen, mit seinen Kunden eine langfristige Partnerschaft aufzubauen, basiert auf Vertrauen und das gegenseitige Zuhören. Jede Entscheidung wurde konzipiert, um einen komplette und eindrucksvollen Service zu garantieren. Aus diesem Grund sind unseren Technische, Kundendienst und Vertriebsleiter immer erreichbar, um Sie auf die aktuellsten Auftragsabwicklung zu bringen bzw. um Ihnen Beratung und Unterstützung bei Kostenvoranschlägen anzubieten.

2. KOMPETENZ UNSERER ARCHITECKTEN UND DESIGNERS

Wir bieten Ihnen die besten von 2D- und 3D-Grafik-Design-Tools, um eine ausgezeichnete Planung der Arbeitsplätze zu realisieren. Wir stellen Ihnen Pcon Planer zur Verfügung, die bekannteste und wichtigste Software für Architekten, Planungsbüro und Designers im Bürobereich, um Ihre tägliche Arbeit zu unterstützen und Ihre Büroplanungen zu erleichtern. Damit können Sie noch virtuellen Bilder, Raumperspektiven, isometrischen und planimetrischen Ansichten erstellen, mit Preisen und Details zu jeder Kollektion. Dazu können Sie noch, falls nötig, Ihre eigenen Artikel in Planung integrieren.



3. LAGERHALTIGKEIT UND SCHNELLE LIEFERZEITEN

Wir sind bewusst, dass es heute immer wichtiger ist, pünktlich und rechtzeitig zu liefern, um die Anforderungen und Bedürfnisse eines internationalen Marktes zu erfüllen. Aus diesem Grund ist die Mehrheit unseres Produktsortimente bei uns am Lager. Alle Artikeln sind mit Etiketten versehen und werden durch Styropor, Thermo-Folie bzw. Karton geschützt. Die Ware wird immer mit verständlichen Montage-Anleitungen, die in der Verpackung enthalten sind, geliefert. Quadrifoglio Group gewährleistet eine prompte Lieferzeit, unterstützt von professionellen Speditionen. Die Abwicklung der Bestellungen durch ausgereifte Datentechnik garantiert Ihnen eine schnelle und zuverlässige Lieferzeit.

4. TECHNISCHEN DATENBLÄTTER

Quadrifoglio Group gibt seinen Kunden und Partners technischen Informationen über die Produkte und kommerziellen Unterlagen wie Kataloge, Preislisten (in Deutsch), Broschüre, Raumplanungen und Zertifizierungen. Unsere Webseite www.quadrifoglio.com bietet Ihnen alle Informationen, Produktbeschreibungen und Bilder, auch zum Downloaden. Immer für Sie da!

Index

03-217

DESIGN CHAIRS & SOFT SEATING

MOON / CITY / CITY DÉCO / COMPASSO / CODE / COVE / CLUE / CELSIUS / CLARK / C-STOOL / CELL / CLOSE /
CLEOPAS / CITY LOUNGE / CITY DÉCO LOUNGE / AVANA / ARCO / ARTE / ACCORD /
ABBEY / ADO / ASTRO / ARMONY / AGIO / ALIAS

218-247

ACCESSORIES & SIDE TABLES

MONTREAL / MIAMI / MELBOURNE / CARE / T01 / T02 / T03 / T05 / T06 /
FLIPPER / PETAL & CLOAK / ALTER EGO

248-283

LIVING TABLES

NINE / EIGHT / SEVEN / SIX / FIVE / THREE / TWO / CREO & GREKO

284-321

STORAGE & PARTITIONING

BLOOM / ZEFIRO / LIBRERIA / BOISERIE / P1 BOISERIE / M3

Residential & Hospitality Collection pricelist

REV.02-2023



Index

Design Chairs	05	MOON	
	06	CITY	
	14	CITY DÉCO	
	19	COMPASSO	
	23	CODE	
	36	COVE	
	69	CLUE	
	107	CELSIUS	
	112	CLARK	
	114	C-STOOL	
	116	CELL	
	120	CLOSE	
	Soft Seating	138	CLEOPAS
		147	CITY LOUNGE
158		CITY DÉCO LOUNGE	
160		AVANA	
172		ARCO	
174		ARTE	
177		ACCORD	
185		ABBEY	
189		ADO	
194		ASTRO	
208		ARMONY	
215		AGIO	
216		ALIAS	

Upholstery / Revêtement / Bezug Upholstery on request / Revêtement sur requete / überzug auf anfrage

UPHOLSTERY / REVETEMENT / BEZUG

Delivery in approximately 4 weeks
Livraison sous 4 semaines environ
Lieferung in ca. 4 Arbeitswochen

UPHOLSTERY ON REQUEST / REVETEMENT SUR REQUETE / ÜBERZUG AUF ANFRAGE

Delivery in approximately 6 week
Livraison sous 6 semaines environ
Lieferung in ca. 6 Arbeitswochen

Moon chair
Chaise Moon
Stuhl Moon

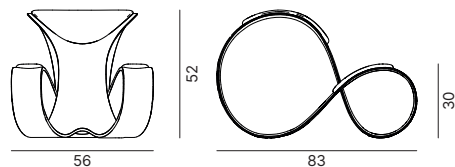



Cod. OMOONV01

Elastic monoshell in variable thickness fibreglass-filled polypropylene; high-elasticity neoprene seat and armpad padding; polyethylene glides for hard floors or recycled polyester fibre pads.

Monocoque élastique en polypropylène renforcé de fibres de verre avec épaisseurs variables; rembourrage de l'assise et pad en néoprène à haute élasticité

Elastischer Stuhlkörper aus Polypropylen, Verstärkung mit Glasfaser, mit veränderlichen Stärken; Sitzpolsterung und hochelastisches Pad aus Neopren; FüÙe aus Polyethylen für harte Fußböden und Filze aus recycelter Polyesterfaser.

 1 box
1 u. x box
0,277 M³

 6,50
8,50



Depending on the surface the color may vary slightly from the reference (RAL / NCS) provided.
En fonction de la surface, la couleur peut varier légèrement par rapport à la référence (RAL / NCS) fournie.
Je nach Oberfläche kann die Farbe in Bezug auf die RAL/NCS Referenz abweichen.

CATAS certificato utente 110 kg

UPHOLSTERY / REVETEMENT / BEZUG

E01/417	E01/428	E01/429	E01/431	E01/421	E01/420
558 PTS	558 PTS	558 PTS	558 PTS	558 PTS	558 PTS

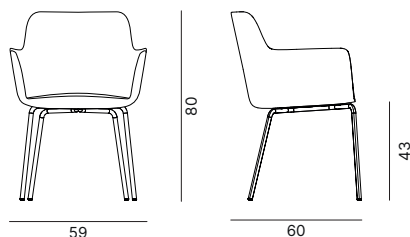

Cod. OCITYV01

Injection molded polyurethane foam shell; steel inner frame; slab polyurethane foam soft pad; base made from chromed or powder coated Ø18mm steel tube; polyethylene glides.

Coque en polyuréthane expansée à mousse avec structure en acier; assise en blocs de mousse en polyuréthane expansée; cadre tube d'acier Ø18 chromé ou verni; patins en polyéthylène.

Stuhlkörper aus Polyurethanschaum mit Stahlgestell; Sitz aus Polyurethanschaum; Gestell aus Stahl Ø18 verchromt oder lackiert; Füße aus Polyethylen.



1M fire retardant B01 fabric upholstery



1 box
1 u. x box
0,300 M³



8,00
10,00





UPHOLSTERY / REVETEMENT / BEZUG

B01/B03	C01/C05	D02/D03	E01	P01
540 PTS	583 PTS	610 PTS	646 PTS	674 PTS

UPHOLSTERY ON REQUEST / REVETEMENT SUR REQUETE / ÜBERZUG AUF ANFRAGE

D04/D06	E02/E03/E04	I01/I02	M01/M02/M03
610 PTS	646 PTS	784 PTS	856 PTS





FRAME / CADRE / GESTELL

	Chrome frame Cadre chromé Verchromtes Gestell	FSC22	=
	Powder coated frame in silver Cadre verni alu Gestell Aluminium lackiert	FSG22	=
	Powder coated frame in white Cadre verni blanc Gestell Weiß lackiert	FSB22	=
	Powder coated frame in anthracite Cadre verni gris ombre Gestell Dunkelgrau lackiert	FST22	=

ACCESSORIES / ACCESSOIRES / ZUBEHÖR

	Set of silent anti-scratch felt pads and glides Kit de patins de feutres et patins anti-rayures et anti-bruit Kit kratzfesten und geräuschkämpfenden Filzgleiter.	ACC13	+19 PTS
---	--	-------	---------

ON REQUEST ONLY / SUR REQUETE / AUF ANFRAGE

	Gold powder coated frame Structure vernie or Gestell Gold lackiert	OR	+131 PTS
	Bronze powder coated frame Structure vernie bronze Gestell Bronze lackiert	BR	+131 PTS
	Corten powder coated frame Structure vernie corten Gestell Corten lackiert	CO	+131 PTS
	Powder coated frame in a special finish, 6-unit minimum order Cadre en coloris spéciaux, à partir de 6 pièces Gestell: Sonderlackierung nach Kundenwunsch, ab 6 Stück Price on request for special varnish finishes / Pour vernis spécifiques, devis sur requête / Sonderlackfarben auf Anfrage	VERN	+83 PTS

City chair, sled base

Chauffeuse City, luge métal

Sessel City, Schlittengestell

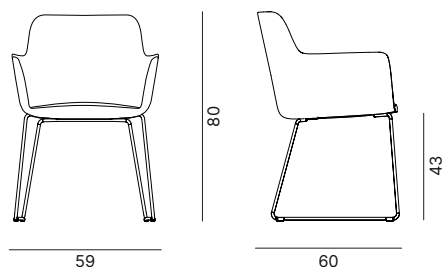

Cod. OCITYV02

Injection molded polyurethane foam shell; steel inner frame; slab polyurethane foam soft pad; base made from chromed or powder coated Ø11mm steel tube; polyethylene glides.

Coque en polyuréthane expansée à mousse avec structure en acier; assise en blocs de mousse en polyuréthane expansée; cadre en acier Ø11 chromé ou verni; patins en polyéthylène.

Stuhlkörper aus Polyurethanschaum mit Stahlgestell; Sitz aus Polyurethanschaum; Gestell Ø11 verchromt oder lackiert; Füße aus Polyethylen.



11M fire retardant B01 fabric upholstery

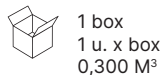

1 box
1 u. x box
0,300 M³



8,50
10,50

UPHOLSTERY / REVETEMENT / BEZUG

B01/B03	C01/C05	D02/D03	E01	P01
540 PTS	583 PTS	610 PTS	646 PTS	674 PTS

UPHOLSTERY ON REQUEST / REVETEMENT SUR REQUETE / ÜBERZUG AUF ANFRAGE

D04/D06	E02/E03/E04	I01/I02	M01/M02/M03
610 PTS	646 PTS	784 PTS	856 PTS

FRAME / CADRE / GESTELL

	Chrome frame Cadre chromé Verchromtes Gestell	FSC23	=
	Powder coated frame in silver Cadre verni alu Gestell Aluminium lackiert	FSG23	=
	Powder coated frame in white Cadre verni blanc Gestell Weiß lackiert	FSB23	=
	Powder coated frame in anthracite Cadre verni gris ombre Gestell Dunkelgrau lackiert	FST23	=

ON REQUEST ONLY / SUR REQUETE / AUF ANFRAGE

	Gold powder coated frame Structure vernie or Gestell Gold lackiert	OR	+131 PTS
	Bronze powder coated frame Structure vernie bronze Gestell Bronze lackiert	BR	+131 PTS
	Corten powder coated frame Structure vernie corten Gestell Corten lackiert	CO	+131 PTS
	Powder coated frame in a special finish, 6-unit minimum order Cadre en coloris spéciaux, à partir de 6 pièces Gestell: Sonderlackierung nach Kundenwunsch, ab 6 Stück Price on request for special varnish finishes / Pour vernis spécifiques, devis sur requête / Sonderlackfarben auf Anfrage	VERN	+83 PTS

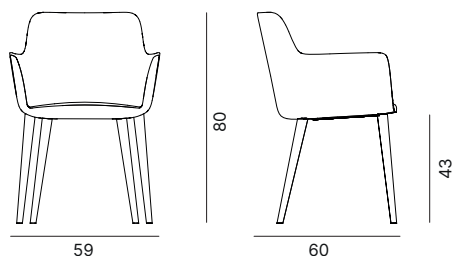

Cod. OCITYV03

Injection molded polyurethane foam shell; steel inner frame; slab polyurethane foam soft pad; chromed steel plate; base made from varnished solid ash wood; polyethylene glides.

Coque en polyuréthane expansée à mousse avec structure en acier; assise en blocs de mousse en polyuréthane expansée; plaque en acier chromé; piètement en frêne massif verni; patins en polyéthylène.

Korpus aus Polyurethanschaum mit Stahlrahmen; Sitz aus blockweise geteiltem Polyurethanschaum; Platte aus verchromtem Stahl; Beine aus lackierter massiver Esche; Füße aus Polyethylen.

CATAS EN 16139 Level 1



1M fire retardant B01 fabric upholstery

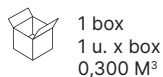

UPHOLSTERY / REVETEMENT / BEZUG

B01/B03	C01/C05	D02/D03	E01	P01
628 PTS	674 PTS	700 PTS	735 PTS	762 PTS

UPHOLSTERY ON REQUEST / REVETEMENT SUR REQUETE / ÜBERZUG AUF ANFRAGE

D04/D06	E02/E03/E04	I01/I02	M01/M02/M03
700 PTS	735 PTS	873 PTS	946 PTS

FRAME / CADRE / GESTELL

	Oak varnished solid ash wood Frêne massif verni chêne Esche massiv Eiche hell lackiert	FSFK3	=
	Walnut varnished solid ash wood Frêne massif verni noyer canaletto Esche massiv Nussbaum Kanaletto lackiert	FSFN3	=

ACCESSORIES / ACCESSOIRES / ZUBEHÖR

	Nylon feet supplied with felt pads for wooden flooring Patins de feutres en nylon Nylonfüße mit Filzgleiter	ACC10	+8 PTS
---	--	--------------	--------

ON REQUEST ONLY / SUR REQUETE / AUF ANFRAGE

	Powder coated frame in a special finish, 10-unit minimum order Cadre en coloris spéciaux, à partir de 10 pièces Gestell: Sonderlackierung nach Kundenwunsch, ab 10 Stück Price on request for special varnish finishes / Pour vernis spécifiques, devis sur requête / Sonderlackfarben auf Anfrage	VERN	+77 PTS
---	--	-------------	---------

City swivel chair, spider base

Chaise City, piètement étoile pivotant

Sessel City, drehbares Metallgestell

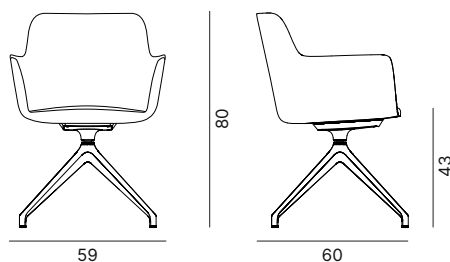

Cod. OCITYV04

Injection molded polyurethane foam shell; steel inner frame; slab polyurethane foam soft pad; matching steel reinforced polyamide plate; Ø700mm four leg swivel spider base made from powder coated die-cast aluminium; no gas lift; silent nylon glides for carpet or hard flooring.

Coque en polyuréthane expansée à mousse avec structure en acier; assise en polyuréthane expansée à blocs; plaque en nylon et acier en teinte avec la base; piètement Ø700mm en alu verni; vérin pivotant sans lift; patins en nylon avec accessoire à glissement sur moquette inclus.

Stuhlkörper aus geschäumtem Polyurethanschaum mit Stahlgestell; Sitz aus geschäumtem Polyurethan als Block geteilt; verstärkte Nylonplatte aus Stahl passend zum Gestell; Sockel Ø700mm aus lackiertem Aluminiumdruckguss; Drehlift ohne Höhenverstellung; Nylonfüße mit Sonderausführung zum Aufschieben auf Teppiche inklusive.

1 box
1 u. x box
0,300 M³

9,00
11,00

 11M fire retardant B01 fabric upholstery



UPHOLSTERY / REVETEMENT / BEZUG

B01/B03	C01/C05	D02/D03	E01	P01
664 PTS	708 PTS	734 PTS	770 PTS	799 PTS

UPHOLSTERY ON REQUEST / REVETEMENT SUR REQUETE / ÜBERZUG AUF ANFRAGE

D04/D06	E02/E03/E04	I01/I02	M01/M02/M03
734 PTS	770 PTS	908 PTS	981 PTS

BASE / BASE / GESTELL

	Powder coated aluminium spider base in silver Piètement 4 branches en alu verni alu avec plaque en teinte 4-Sternfußkreuz Alu pulverbeschichtet mit Unterplatte in gleicher Farbe	BAA19	=
	Powder coated aluminium spider base in white Piètement 4 branches en alu verni blanc avec plaque en teinte 4-Sternfußkreuz Weiß pulverbeschichtet mit Unterplatte in gleicher Farbe	BAA20	=
	Powder coated aluminium spider base in anthracite Piètement 4 branches en alu verni gris ombre avec plaque en teinte 4-Sternfußkreuz Dunkelgrau pulverbeschichtet mit Unterplatte in gleicher Farbe	BAA21	=

ACCESSORIES / ACCESSOIRES / ZUBEHÖR

	Felt pads Patins de feutre Filzgleiter	ACC14	+2 PTS
---	---	--------------	--------

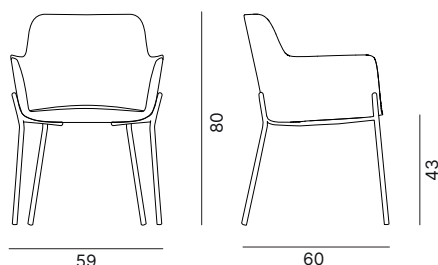

Cod. OCITYV06

Injection molded polyurethane foam shell; steel inner frame; slab polyurethane foam soft pad; frame in powder coated steel tube; polyethylene glides.

Coque en polyuréthane expansée à mousse avec structure en acier; assise en blocs de mousse en polyuréthane expansée; cadre en tube d'acier verni; patins en polyéthylène.

Stuhlkörper aus Polyurethanschaum mit Stahlgestell; Sitz aus Polyurethanschaum; Gestell aus Stahlrohr lackiert; FüÙe aus Polyethylen.



1M fire retardant B01 fabric upholstery



1 box
1 u. x box
0,300 M³



8,50
10,50

UPHOLSTERY / REVETEMENT / BEZUG

B01/B03	C01/C05	D02/D03	E01	P01
708 PTS	738 PTS	761 PTS	814 PTS	979 PTS

UPHOLSTERY ON REQUEST / REVETEMENT SUR REQUETE / ÜBERZUG AUF ANFRAGE

D04/D06	E02/E03/E04	I01/I02	M01/M02/M03
761 PTS	814 PTS	953 PTS	1025 PTS





FRAME / CADRE / GESTELL

	Powder coated frame in anthracite Cadre verni gris ombre Gestell Dunkelgrau lackiert	FST31	=
---	---	--------------	---

ACCESSORIES / ACCESSOIRES / ZUBEHÖR

	Protective pads for hardwood Feutre pour sols en bois Filzgleiter für Holzböden	ACC21	+19 PTS
---	--	--------------	---------

ON REQUEST ONLY / SUR REQUETE / AUF ANFRAGE

	Gold powder coated frame Structure vernie or Gestell Gold lackiert	OR	+131 PTS
	Bronze powder coated frame Structure vernie bronze Gestell Bronze lackiert	BR	+131 PTS
	Corten powder coated frame Structure vernie corten Gestell Corten lackiert	CO	+131 PTS
	Powder coated frame in a special finish, 6-unit minimum order Cadre en coloris spéciaux, à partir de 6 pièces Gestell: Sonderlackierung nach Kundenwunsch, ab 6 Stück <small>Price on request for special varnish finishes / Pour vernis spécifiques, devis sur requête / Sonderlackfarben auf Anfrage</small>	VERN	+85 PTS

City chair, cantilever base
 Chauffeuse City, luge cantilever métal
 Sessel City, Besucherstuhl

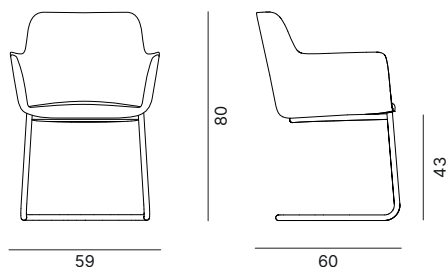

Cod. OCITYV07

Injection molded polyurethane foam shell; steel inner frame; slab polyurethane foam soft pad; base made from chromed or powder coated Ø22mm steel tube; polyethylene glides.

Coque en polyuréthane expansée à mousse avec structure en acier; assise en blocs de mousse en polyuréthane expansée; cadre en acier Ø22 chromé ou verni; patins en polyéthylène.

Stuhlkörper aus Polyurethanschaum mit Stahlgestell; Sitz aus Polyurethanschaum; Gestell Ø22 verchromt oder lackiert; Füße aus Polyethylen.

EN 16139 Level 1



11M fire retardant B01 fabric upholstery

 1 box
 1 u. x box
 0,300 M³

 10,00
 12,00

UPHOLSTERY / REVETEMENT / BEZUG

B01/B03	C01/C05	D02/D03	E01	P01
591 PTS	638 PTS	664 PTS	697 PTS	727 PTS

UPHOLSTERY ON REQUEST / REVETEMENT SUR REQUETE / ÜBERZUG AUF ANFRAGE

D04/D06	E02/E03/E04	I01/I02	M01/M02/M03
664 PTS	697 PTS	836 PTS	908 PTS

FRAME / CADRE / GESTELL

	Chrome frame Cadre chromé Verchromtes Gestell	FSC24	=
	Powder coated frame in silver Cadre verni alu Gestell Aluminium lackiert	FSG24	=
	Powder coated frame in white Cadre verni blanc Gestell Weiß lackiert	FSB24	=
	Powder coated frame in anthracite Cadre verni gris ombre Gestell Dunkelgrau lackiert	FST24	=

ON REQUEST ONLY / SUR REQUETE / AUF ANFRAGE

	Gold powder coated frame Structure vernie or Gestell Gold lackiert	OR	+131 PTS
	Bronze powder coated frame Structure vernie bronze Gestell Bronze lackiert	BR	+131 PTS
	Corten powder coated frame Structure vernie corten Gestell Corten lackiert	CO	+131 PTS
	Powder coated frame in a special finish, 6-unit minimum order Cadre en coloris spéciaux, à partir de 6 pièces Gestell: Sonderlackierung nach Kundenwunsch, ab 6 Stück Price on request for special varnish finishes / Pour vernis spécifiques, devis sur requête / Sonderlackfarben auf Anfrage	VERN	+83 PTS

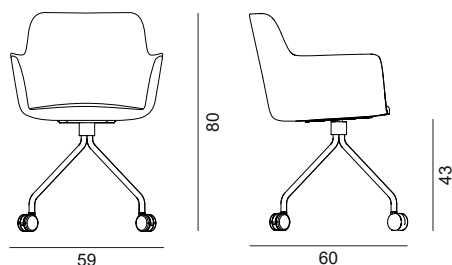

Cod. OCITYA02

Injection molded polyurethane foam shell; steel inner frame; slab polyurethane foam soft pad; base made from chromed or powder coated steel .

Coque en polyuréthane expansée à mousse avec structure en acier; assise en polyuréthane expansée à blocs; cadre tube d'acier chromé ou verni.

Körper aus geschäumtem Polyurethanschaum mit Stahlgestell; Sitz aus geschäumtem Polyurethan als Block geformt; Gestell aus verchromtem oder lackiertem Stahlrohr.

CATAS EN 16139 Level 1



1M fire retardant B01 fabric upholstery

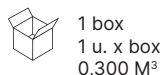

1 box
1 u. x box
0,300 M³



10,00
12,00

UPHOLSTERY / REVETEMENT / BEZUG

B01/B03	C01/C05	D02/D03	E01	P01
628 PTS	674 PTS	700 PTS	735 PTS	762 PTS

UPHOLSTERY ON REQUEST / REVETEMENT SUR REQUETE / ÜBERZUG AUF ANFRAGE

D04/D06	E02/E03/E04	I01/I02	M01/M02/M03
700 PTS	735 PTS	873 PTS	946 PTS

BASE / BASE / GESTELL

	4-star base on castors, chromed Base 4 roulettes chromée 4-Sternfußkreuz verchromt	BAF09	=
	4-star base on castors, powder coated in silver Base 4 roulettes vernie alu 4-Sternfußkreuz Alu pulverbeschichtet	BAF10	=
	4-star base on castors, powder coated in white Base 4 roulettes vernie en blanc 4-Sternfußkreuz Weiß pulverbeschichtet	BAF11	=
	4-star base on castors, powder coated in anthracite Base 4 roulettes vernie en gris ombre 4-Sternfußkreuz Dunkelgrau pulverbeschichtet	BAF12	=



ACCESSORIES / ACCESSOIRES / ZUBEHÖR

	65mmØ twin wheel brake unloaded hard black castors Roulettes standard Ø65mm- autofreinées Standard-Rollen Ø65mm - selbstbremsend	RG06	=
	65mmØ twin wheel brake unloaded soft black castors Roulettes sol dur Ø65mm - autofreinées Gummirollen Ø65mm - selbstbremsend	RG02	+25 PTS
	60mmØ twin wheel unbraked white soft castors Roulettes sol dur blanches Ø60mm - libres Weiße Gummirollen Ø60mm	RG07	+33 PTS
	60mmØ twin wheel unbraked silver soft castors Roulettes sol dur alu Ø60mm - libres Aluminium-Gummirollen Ø60mm	RG08	+33 PTS

City chair, 4-star base on castors

Chauffeuse City, piètement 4 roulettes

Sessel City, 4-Rollen Fußkreuz

ACCESSORIES / ACCESSOIRES / ZUBEHÖR			
	65mmØ twin wheel brake unloaded ring-shaped white soft castors Roulettes "ring" sol dur blanches Ø65mm - autofreinées Weiß gummierte "Ring"-Rollen Ø65mm - selbstbremsend	RG09	+51 PTS
	65mmØ twin wheel brake unloaded ring-shaped soft silver castors Roulettes "ring" sol dur alu Ø65mm - autofreinées Gummierte Aluminium "Ring"-Rollen Ø65mm - selbstbremsend	RG10	+51 PTS
ON REQUEST ONLY / SUR REQUETE / AUF ANFRAGE			
	Powder coated frame in a special finish, 6-unit minimum order Cadre en coloris spéciaux, à partir de 6 pièces Gestell: Sonderlackierung nach Kundenwunsch, ab 6 Stück Price on request for special varnish finishes / Pour vernis spécifiques, devis sur requête / Sonderlackfarben auf Anfrage	VERN	+104 PTS

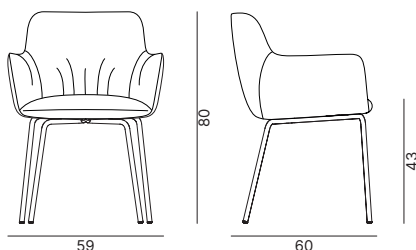

Cod. OCIDEV01

Shell in injection moulded polyurethane foam with steel frame; slab polyurethane foam seat; frame in Ø18mm steel tube chrome or powder coated; adjustable polyethylene glides with felt pad or base for hard floors; soft pleated upholstery.

Coque en mousse de polyuréthane expansé avec structure en acier; assise en mousse de polyuréthane expansée sectionnée à partir du bloc; cadre en tube d'acier Ø11mm chromé ou verni; patins réglables en polyéthylène avec feutre ou avec base pour sols durs; revêtement avec plis souples.

Sitzschale aus geschäumtem Polyurethanschaum mit Gestell aus Stahl; Sitz aus Polyurethanschaum, in Block geschnitten; Gestell aus Stahlrohr Durchmesser 18mm verchromt oder lackiert; schwenkbare FüÙe aus Polyethylen mit Filz oder Sockel für harte Fußböden; Überzug mit weichen Falten.

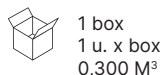

1 box
1 u. x box
0,300 M³

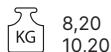

8,20
10,20

UPHOLSTERY / REVETEMENT / BEZUG

D02/D03	E01
676 PTS	736 PTS





UPHOLSTERY ON REQUEST / REVETEMENT SUR REQUETE / ÜBERZUG AUF ANFRAGE

D04	E02/E03/E04	I01
676 PTS	736 PTS	796 PTS

FRAME / CADRE / GESTELL

	Chrome frame Cadre chromé Verchromtes Gestell	FSC22	=
	Powder coated frame in silver Cadre verni alu Gestell Aluminium lackiert	FSG22	=
	Powder coated frame in white Cadre verni blanc Gestell Weiß lackiert	FSB22	=
	Powder coated frame in anthracite Cadre verni gris ombre Gestell Dunkelgrau lackiert	FST22	=

ON REQUEST ONLY / SUR REQUETE / AUF ANFRAGE

	Gold powder coated frame Structure vernie or Gestell Gold lackiert	OR	+95 PTS
	Bronze powder coated frame Structure vernie bronze Gestell Bronze lackiert	BR	+127 PTS
	Corten powder coated frame Structure vernie corten Gestell Corten lackiert	CO	+127 PTS
	Powder coated frame in a special finish, 6-unit minimum order Cadre en coloris spéciaux, à partir de 6 pièces Gestell: Sonderlackierung nach Kundenwunsch, ab 6 Stück <small>Price on request for special varnish finishes / Pour vernis spécifiques, devis sur requête / Sonderlackfarben auf Anfrage</small>	VERN	+85 PTS

ACCESSORIES / ACCESSOIRES / ZUBEHÖR

	Set of silent anti-scratch felt pads and glides Kit de patins de feutres et patins anti-rayures et anti-bruit Kit kratzfesten und geräuschkämpfenden Filzgleiter.	ACC13	+19 PTS
---	--	-------	---------

City Déco chair, metal sled base Chaufeuse City Déco, pieds luge métal Armsessel City Déco, Schlitten Metall

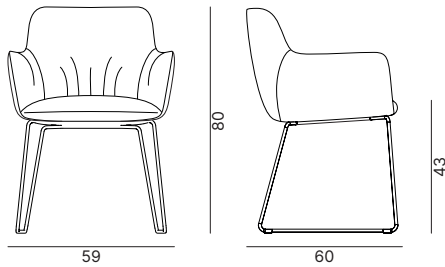

Cod. OCIDEV02

Shell in injection moulded polyurethane foam with steel frame; slab polyurethane foam seat; frame in Ø11mm steel tube chromed or powder coated; soft pleated upholstery.

Coque en mousse de polyuréthane expansé avec structure en acier; assise en mousse de polyuréthane expansée sectionnée à partir du bloc; cadre en tube d'acier Ø11mm chromé ou verni; revêtement avec plis souples.

Sitzschale aus geschäumtem Polyurethanschaum mit Gestell aus Stahl; Sitz aus Polyurethanschaum, in Block geschnitten; Gestell aus Rundstahl Durchmesser 11mm verchromt oder lackiert; Überzug mit weichen Falten.

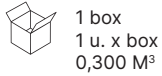

1 box
1 u. x box
0,300 M³



8,60
10,60

UPHOLSTERY / REVETEMENT / BEZUG

D02/D03	E01
676 PTS	736 PTS





UPHOLSTERY ON REQUEST / REVETEMENT SUR REQUETE / ÜBERZUG AUF ANFRAGE

D04	E02/E03/E04	I01
676 PTS	736 PTS	796 PTS

FRAME / CADRE / GESTELL

	Chrome frame Cadre chromé Verchromtes Gestell	FSC23	=
	Powder coated frame in silver Cadre verni alu Gestell Aluminium lackiert	FSG23	=
	Powder coated frame in white Cadre verni blanc Gestell Weiß lackiert	FSB23	=
	Powder coated frame in anthracite Cadre verni gris ombre Gestell Dunkelgrau lackiert	FST23	=

ON REQUEST ONLY / SUR REQUETE / AUF ANFRAGE

	Gold powder coated frame Structure vernie or Gestell Gold lackiert	OR	+95 PTS
	Bronze powder coated frame Structure vernie bronze Gestell Bronze lackiert	BR	+127 PTS
	Corten powder coated frame Structure vernie corten Gestell Corten lackiert	CO	+127 PTS
	Powder coated frame in a special finish, 6-unit minimum order Cadre en coloris spéciaux, à partir de 6 pièces Gestell: Sonderlackierung nach Kundenwunsch, ab 6 Stück <small>Price on request for special varnish finishes / Pour vernis spécifiques, devis sur requête / Sonderlackfarben auf Anfrage</small>	VERN	+85 PTS

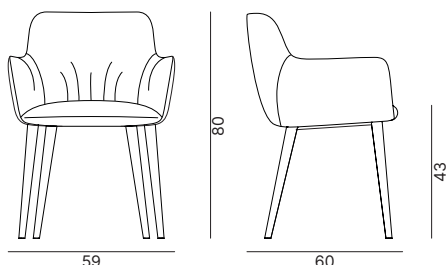

Cod. OCIDEV03

Shell in injection moulded polyurethane foam with steel frame; chromed steel plate; legs in varnished solid ash wood; polyethylene glides; soft pleated upholstery.

Coque en mousse de polyuréthane expansé avec structure en acier; plaque en acier chromé; piètement en frêne massif verni; patins en polyéthylène; revêtement avec plis souples.

Sitzschale aus geschäumtem Polyurethanschaum mit Gestell aus Stahl; Platte aus verchromtem Stahl; Beine aus massiver Esche lackiert; Füße aus Polyethylen; Überzug mit weichen Falten.

CATAS EN 16139 Level 1



1 box
1 u. x box
0,300 M³



8,50
10,50

UPHOLSTERY / REVETEMENT / BEZUG

D02/D03	E01
763 PTS	823 PTS

UPHOLSTERY ON REQUEST / REVETEMENT SUR REQUETE / ÜBERZUG AUF ANFRAGE

D04	E02/E03/E04	I01
763 PTS	823 PTS	883 PTS

FRAME / CADRE / GESTELL

	Oak varnished solid ash wood Frêne massif verni chêne Esche massiv Eiche hell lackiert	FSFK3	=
	Walnut varnished solid ash wood Frêne massif verni noyer canaletto Esche massiv Nussbaum Kanaletto lackiert	FSFN3	=

ON REQUEST ONLY / SUR REQUETE / AUF ANFRAGE

	Powder coated legs in a special finish, 6-unit minimum order Piètement en coloris spéciaux, à partir de 6 pièces Gestell nach Kundenwunsch, ab 6 Stück <small>Price on request for special varnish finishes / Pour vernis spécifiques, devis sur requête / Sonderlackfarben auf Anfrage</small>	VERN	+42 PTS
---	---	------	---------

ACCESSORIES / ACCESSOIRES / ZUBEHÖR

	Nylon feet supplied with felt pads for wooden flooring Patins de feutres en nylon Nylonfüße mit Filzgleiter	ACC10	+8 PTS
---	--	-------	--------

City Déco chair, 4 déco legs

Chaufeuse City Déco, 4 pieds déco

Armsessel City Déco, 4 Füße déco

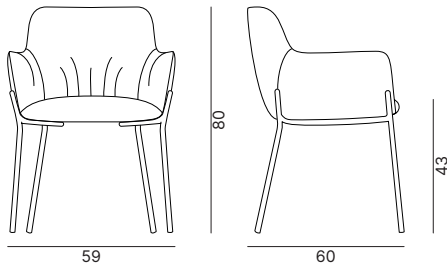

Cod. OCIDEV06

Shell in injection moulded polyurethane foam with steel frame; slab polyurethane foam seat; frame in powder coated steel tube; polyethylene glides; soft pleated upholstery.

Coque en mousse de polyuréthane expansé avec structure en acier; assise en mousse de polyuréthane expansée sectionnée à partir du bloc; cadre en tube d'acier verni; patins en polyéthylène; revêtement avec plis souples.

Sitzschale aus geschäumtem Polyurethanschaum mit Gestell aus Stahl; Sitz aus Polyurethanschaum, in Block geschnitten; Gestell aus Stahlrohr lackiert; Füße aus Polyethylen; Überzug mit weichen Falten.

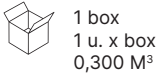

1 box
1 u. x box
0,300 M³



8,20
10,20

UPHOLSTERY / REVETEMENT / BEZUG

D02/D03	E01
864 PTS	923 PTS





UPHOLSTERY ON REQUEST / REVETEMENT SUR REQUETE / ÜBERZUG AUF ANFRAGE

D04	E02/E03/E04	I01
864 PTS	923 PTS	984 PTS

FRAME / CADRE / GESTELL

	Powder coated frame in anthracite Cadre verni gris ombre Gestell Dunkelgrau lackiert	FST31	=
--	---	-------	---

ON REQUEST ONLY / SUR REQUETE / AUF ANFRAGE

	Gold powder coated frame Structure vernie or Gestell Gold lackiert	OR	+95 PTS
	Bronze powder coated frame Structure vernie bronze Gestell Bronze lackiert	BR	+127 PTS
	Corten powder coated frame Structure vernie corten Gestell Corten lackiert	CO	+127 PTS
	Powder coated frame in a special finish, 6-unit minimum order Cadre en coloris spéciaux, à partir de 6 pièces Gestell: Sonderlackierung nach Kundenwunsch, ab 6 Stück <small>Price on request for special varnish finishes / Pour vernis spécifiques, devis sur requête / Sonderlackfarben auf Anfrage</small>	VERN	+85 PTS

ACCESSORIES / ACCESSOIRES / ZUBEHÖR

	Protective pads for hardwood Feutre pour sols en bois Filzgleiter für Holzböden	ACC21	+4 PTS
--	--	-------	--------

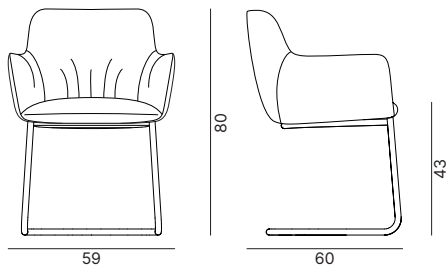

Cod. OCIDEV07

Injection molded polyurethane foam shell; steel inner frame; slab polyurethane foam soft pad; base made from chromed or powder coated Ø22mm steel tube; polyethylene glides; soft pleated upholstery.

Coque en polyuréthane expansée à mousse avec structure en acier; assise en blocs de mousse en polyuréthane expansée; cadre en acier Ø22 chromé ou verni; patins en polyéthylène; revêtement avec plis souples.

Stuhlkörper aus Polyurethanschaum mit Stahlgestell; Sitz aus Polyurethanschaum; Gestell Ø22 verchromt oder lackiert; Füße aus Polyethylen; Überzug mit weichen Falten.

CATAS EN 16139 Level 1

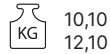
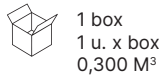

UPHOLSTERY / REVETEMENT / BEZUG

D02/D03	E01
727 PTS	787 PTS





UPHOLSTERY ON REQUEST / REVETEMENT SUR REQUETE / ÜBERZUG AUF ANFRAGE

D04	E02/E03/E04	I01
727 PTS	787 PTS	847 PTS

FRAME / CADRE / GESTELL

	Chrome frame Cadre chromé Verchromtes Gestell	FSC24	=
	Powder coated frame in silver Cadre verni alu Gestell Aluminium lackiert	FSG24	=
	Powder coated frame in white Cadre verni blanc Gestell Weiß lackiert	FSB24	=
	Powder coated frame in anthracite Cadre verni gris ombre Gestell Dunkelgrau lackiert	FST24	=

ON REQUEST ONLY / SUR REQUETE / AUF ANFRAGE

	Gold powder coated frame Structure vernie or Gestell Gold lackiert	OR	+95 PTS
	Bronze powder coated frame Structure vernie bronze Gestell Bronze lackiert	BR	+127 PTS
	Corten powder coated frame Structure vernie corten Gestell Corten lackiert	CO	+127 PTS
	Powder coated frame in a special finish, 6-unit minimum order Cadre en coloris spéciaux, à partir de 6 pièces Gestell: Sonderlackierung nach Kundenwunsch, ab 6 Stück <small>Price on request for special varnish finishes / Pour vernis spécifiques, devis sur requête / Sonderlackfarben auf Anfrage</small>	VERN	+85 PTS

Compasso chair
Chaise Compasso
Stuhl Compasso

COMPASSO

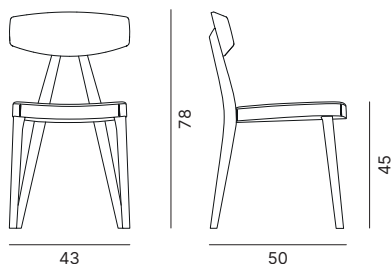

Cod. OCOMPV01

Frame in natural varnished solid ash wood; seat in veneered ash plywood; back in veneered variable-thickness ash plywood, curved; anti-vibration glides with felt pad or runner for hard floors.

Structure en frêne massif verni naturel; assise en multi-plis placage frêne; dossier en multi-plis placage frêne à épaisseur variable, courbe; patins feutrés anti-vibration ou avec patins pour sol dur

Gestell aus massiver Esche, naturfarben lackiert; Sitz aus mehrschichtigem Eschenholz furniert; Rückenlehne aus mehrschichtigem Eschenholz furniert mit veränderlichen Stärken, gebogen; Vibrerschutzzüße mit Filz oder Kufe für harte Fußböden.

1 box
2 u. x box
0,280 M³



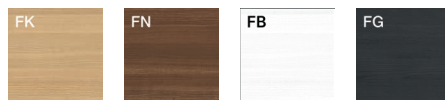

9,40
12,40
KG





For the total price sum together back, seat and frame
Pour le prix total additionner dossier, assise et piètement
Für den Gesamtpreis Rückenlehne, Sitz und Gestell zusammenaddieren

CATAS EN 16139 Level 1



FRAME / CADRE / GESTELL

	Oak varnished solid ash wood Frêne massif verni chêne Esche massiv Eiche hell lackiert	FSFK6	467 PTS
	Walnut varnished solid ash wood Frêne massif verni noyer canaletto Esche massiv Nussbaum Kanaletto lackiert	FSFN6	467 PTS
	White varnished solid ash wood Frêne massif verni blanc Massive Esche weiß lackiert	FSFB6	478 PTS
	Anthracite varnished solid ash wood Frêne massif verni gris ombre Esche massiv Dunkelgrau lackiert	FSFG6	478 PTS

SEAT & BACK FINISH OPTIONS / FINITION ASSISE ET DOSSIER / SITZ- UND RÜCKENLEHNENAUSFÜHRUNG

	Oak varnished solid ash wood Frêne massif verni chêne Esche massiv Eiche hell lackiert	FK	+159 PTS
	Walnut varnished solid ash wood Frêne massif verni noyer canaletto Esche massiv Nussbaum Kanaletto lackiert	FN	+159 PTS
	White varnished solid ash wood Frêne massif verni blanc Massive Esche weiß lackiert	FB	+170 PTS
	Anthracite varnished solid ash wood Frêne massif verni gris ombre Esche massiv Dunkelgrau lackiert	FG	+170 PTS

ON REQUEST ONLY / SUR REQUETE / AUF ANFRAGE

	<p>Powder coated frame in a special finish, 6-unit minimum order Cadre en coloris spéciaux, à partir de 6 pièces <i>Gestell: Sonderlackierung nach Kundenwunsch, ab 6 Stück</i></p>	<p>VERN</p>	<p>+48 PTS</p>
<p><small>Price on request for special varnish finishes / Pour vernis spécifiques, devis sur requête / Sonderlackfarben auf Anfrage</small></p>			
	<p>Powder coated seat and back in a special finish, 6-unit minimum order Peinture assise et dossier personnalisée, minimum 6 pièces <i>Lackierung Sitz und Rückenlehne nach Kundenwunsch, mindestens 6 Stück</i></p>	<p>VERN</p>	<p>+37 PTS</p>
<p><small>Price on request for special varnish finishes / Pour vernis spécifiques, devis sur requête / Sonderlackfarben auf Anfrage</small></p>			

ACCESSORIES / ACCESSOIRES / ZUBEHÖR

	<p>Felt pads Patins de feutre <i>Filzgleiter</i></p>	<p>ACC20</p>	<p>+8 PTS</p>
---	---	---------------------	----------------------

Compasso chair with padded seat

Chaise Compasso avec assise rembourré

Stuhl Compasso mit Sitz gepolstert

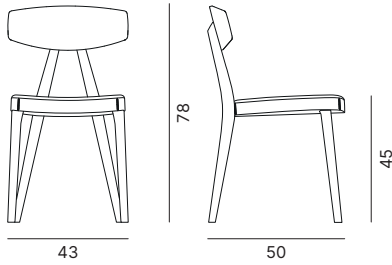

Cod. OCOMPV11

Frame in natural varnished solid ash wood; inner plywood seat; slab polyurethane foam seat padding; back in veneered variable-thickness ash plywood, curved; anti-vibration glides with felt pad or runner for hard floors.

Structure en frêne massif verni naturel; assise interne en multi-plis; rembourrage assise en polyuréthane expansé à blocs; dossier en multi-plis placage frêne à épaisseur variable, courbe; patins feutrés anti-vibration ou avec patins pour sol dur

Gestell aus massiver Esche, naturfarben lackiert; interner Sitz aus mehrschichtigem Holz; Polsterung des Sitzes aus Polyurethanschaum, in Block geschnitten; Rückenlehne aus mehrschichtigem Eschenholz furniert mit veränderlichen Stärken, gebogen; Vibrierschutzfüße mit Filz oder Kufe für harte Fußböden.

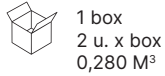

1 box
2 u. x box
0,280 M³



9,60
12,60

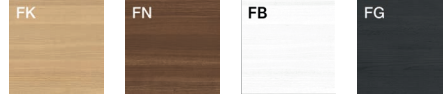





For the total price sum together back, seat and frame

Pour le prix total additionner dossier, assise et piètement





Für den Gesamtpreis Rückenlehne, Sitz und Gestell zusammenaddieren

CATAS EN 16139 Level 1

FRAME / CADRE / GESTELL

	Oak varnished solid ash wood Frêne massif verni chêne <i>Esche massiv Eiche hell lackiert</i>	FSFK6	467 PTS
	Walnut varnished solid ash wood Frêne massif verni noyer canaletto <i>Esche massiv Nussbaum Kanaletto lackiert</i>	FSFN6	467 PTS
	White varnished solid ash wood Frêne massif verni blanc <i>Massive Esche weiß lackiert</i>	FSFB6	478 PTS
	Anthracite varnished solid ash wood Frêne massif verni gris ombre <i>Esche massiv Dunkelgrau lackiert</i>	FSFG6	478 PTS

BACKREST FINISH OPTIONS / FINITION DOSSIER / RÜCKENLEHNENAUSFÜHRUNG

	Oak varnished solid ash wood Frêne massif verni chêne <i>Esche massiv Eiche hell lackiert</i>	FK	+117 PTS
	Walnut varnished solid ash wood Frêne massif verni noyer canaletto <i>Esche massiv Nussbaum Kanaletto lackiert</i>	FN	+117 PTS
	White varnished solid ash wood Frêne massif verni blanc <i>Massive Esche weiß lackiert</i>	FB	+127 PTS
	Anthracite varnished solid ash wood Frêne massif verni gris ombre <i>Esche massiv Dunkelgrau lackiert</i>	FG	+127 PTS



SEAT UPHOLSTERY / REVETEMENT ASSISE / ÜBERZUG SITZ

B03	C05	D02/D03/D05	E01	P01
+35 PTS	+40 PTS	+46 PTS	+56 PTS	+69 PTS

SEAT UPHOLSTERY ON REQUEST / REVETEMENT ASSISE SUR REQUETE / ÜBERZUG SITZ AUF ANFRAGE

D04	E02/E03/E04	I01/I02
+46 PTS	+56 PTS	+85 PTS

ON REQUEST ONLY / SUR REQUETE / AUF ANFRAGE

	<p>Powder coated frame in a special finish, 6-unit minimum order Cadre en coloris spéciaux, à partir de 6 pièces <i>Gestell: Sonderlackierung nach Kundenwunsch, ab 6 Stück</i></p> <p><small>Price on request for special varnish finishes / Pour vernis spécifiques, devis sur requête / Sonderlackfarben auf Anfrage</small></p>	VERN	+48 PTS
	<p>Powder coated seat and back in a special finish, 6-unit minimum order Peinture assise et dossier personnalisée, minimum 6 pièces <i>Lackierung Sitz und Rückenlehne nach Kundenwunsch, mindestens 6 Stück</i></p> <p><small>Price on request for special varnish finishes / Pour vernis spécifiques, devis sur requête / Sonderlackfarben auf Anfrage</small></p>	VERN	+37 PTS

ACCESSORIES / ACCESSOIRES / ZUBEHÖR

	<p>Felt pads Patins de feutre <i>Filzgleiter</i></p>	ACC20	+8 PTS
---	---	--------------	--------

Code wooden chair, 4 metal legs

Chaise Code bois, 4 pieds métal

Stuhl Code Holz, 4 Metallbeine

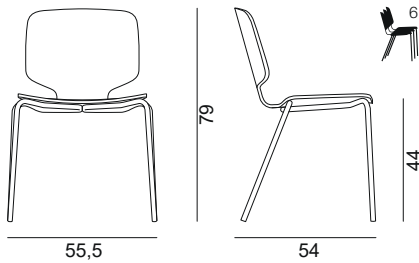

Cod. OCODEV01

Beech plywood shell finished in lacquer or veneered and varnished in oak or walnut. 4-leg metal frame made from 2mm thick 18mmØ steel tube, in chrome or epoxy powder coated. Polypropylene glides.

Coque laquée en multi-plis de hêtre ou bois placage finition frêne verni chêne ou noyer. Structure 4 pieds en tube d'acier D18mm ép.2mm chromé ou verni à poudre époxy. Patins en polypropylène.

Sitzschale aus Buchensperrholz lackiert oder aus Eschenfurnier Eiche hell- oder Nussbaumfarbig-lackiert. 4-Bein Gestell aus Stahlrohr Ø 18mm 2mm stark verchromt oder epoxydpuverbeschichtet. Füße aus Polypropylen.

1 box
2 u. x box
0,174 M³

10,40
13,40



Depending on the surface the color may vary slightly from the reference (RAL / NCS) provided.
En fonction de la surface, la couleur peut varier légèrement par rapport à la référence (RAL / NCS) fournie.
Je nach Oberfläche kann die Farbe in Bezug auf die RAL/NCS Referenz abweichen.

FINISH OPTIONS / FINITION / AUSFÜHRUNG

FK	FN	LB	NW	LH	LO
303 PTS	303 PTS	283 PTS	283 PTS	283 PTS	283 PTS

FRAME / CADRE / GESTELL

	Chrome frame Cadre chromé Verchromtes Gestell	FSC25	=
	Powder coated frame in anthracite Cadre verni gris ombre Gestell Dunkelgrau lackiert	FST25	=

ACCESSORIES / ACCESSOIRES / ZUBEHÖR

	Set of silent anti-scratch felt pads and glides Kit de patins de feutres et patins anti-rayures et anti-bruit Kit kratzfesten und geräuschkämpfenden Filzgleiter.	ACC13	+19 PTS
--	--	--------------	---------

ON REQUEST ONLY / SUR REQUETE / AUF ANFRAGE

	Bronze powder coated frame Structure vernie bronze Gestell Bronze lackiert	BR	+131 PTS
	Gold powder coated frame Structure vernie or Gestell Gold lackiert	OR	+131 PTS
	Corten powder coated frame Structure vernie corten Gestell Corten lackiert	CO	+131 PTS
	Powder coated shell in a special finish, 8-unit minimum order Coque en coloris spéciaux, à partir de 8 pièces Sitzschale: Sonderlackierung nach Kundenwunsch, ab 8 Stück <small>Price on request for special varnish finishes / Pour vernis spécifiques, devis sur requête / Sonderlackfarben auf Anfrage</small>	VERN	+28 PTS
	Powder coated frame in a special finish, 6-unit minimum order Cadre en coloris spéciaux, à partir de 6 pièces Gestell: Sonderlackierung nach Kundenwunsch, ab 6 Stück <small>Price on request for special varnish finishes / Pour vernis spécifiques, devis sur requête / Sonderlackfarben auf Anfrage</small>	VERN	+83 PTS

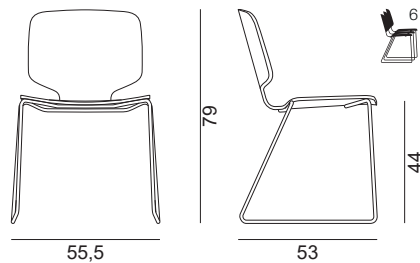

1 box
2 u. x box
0,174 M³



15,00
18,00

Cod. OCODEV02

Beech plywood shell finished in lacquer or veneered and varnished in oak or walnut. Sled base made from 12mmØ chromed steel rod. Polyethylene glides.

Coque laquée en multi-plis de hêtre ou bois placage finition frêne verni chêne ou noyer. Structure en tube d'acier D12 chromé. Patins en polyéthylène.

Sitzschale aus Buchensperrholz lackiert oder aus Eschenfurnier Eiche hell- oder Nussbaumfarbig-lackiert. Gestell aus Stahlrohr Ø 12 mm verchromt. Füße aus Polypropylen.



Depending on the surface the color may vary slightly from the reference (RAL / NCS) provided.
En fonction de la surface, la couleur peut varier légèrement par rapport à la référence (RAL / NCS) fournie.
Je nach Oberfläche kann die Farbe in Bezug auf die RAL/NCS Referenz abweichen.





FINISH OPTIONS / FINITION / AUSFÜHRUNG

FK	FN	LB	NW	LH	LO
307 PTS	307 PTS	290 PTS	290 PTS	290 PTS	290 PTS

FRAME / CADRE / GESTELL

	Chrome frame Cadre chromé Verchromtes Gestell	FSC26	=
---	--	-------	---

ON REQUEST ONLY / SUR REQUETE / AUF ANFRAGE

	Bronze powder coated frame Structure vernie bronze Gestell Bronze lackiert	BR	+131 PTS
	Gold powder coated frame Structure vernie or Gestell Gold lackiert	OR	+131 PTS
	Corten powder coated frame Structure vernie corten Gestell Corten lackiert	CO	+131 PTS
	Powder coated shell in a special finish, 8-unit minimum order Coque en coloris spéciaux, à partir de 8 pièces Sitzschale: Sonderlackierung nach Kundenwunsch, ab 8 Stück <small>Price on request for special varnish finishes / Pour vernis spécifiques, devis sur requête / Sonderlackfarben auf Anfrage</small>	VERN	+28 PTS
	Powder coated frame in a special finish, 6-unit minimum order Cadre en coloris spéciaux, à partir de 6 pièces Gestell: Sonderlackierung nach Kundenwunsch, ab 6 Stück <small>Price on request for special varnish finishes / Pour vernis spécifiques, devis sur requête / Sonderlackfarben auf Anfrage</small>	VERN	+83 PTS

Code wooden chair, 4 wooden legs

Chaise Code bois, 4 pieds bois

Stuhl Code Holz, 4 Holzbeine

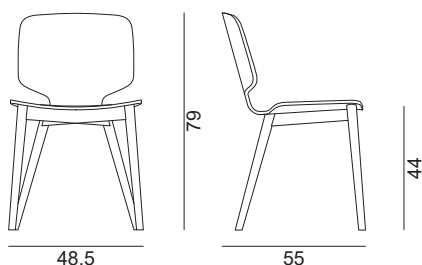

Cod. OCODEV03

Beech plywood shell finished in lacquer or veneered and varnished in oak or walnut. 4-leg frame made from tapered ash solid wood, 36mm \varnothing max/24mm \varnothing min. Varnished in oak or walnut finish or lacquered in the shown colours. Polypropylene glides.

Coque laquée en multi-plis de hêtre ou bois placage finition frêne verni chêne ou noyer. Structure en frêne massif diamètre variable da D36 à D24mm. Verni chêne ou dans les coloris indiqués. Patins en polypropylène.

Sitzschale aus Buchensperrholz lackiert oder aus Eschenfurnier Eiche hell- oder Nussbaumfarbig-lackiert. Gestell aus massivem Eschenholz mit variablem Durchmesser, der sich von \varnothing 36 auf \varnothing 24 mm verjüngt. Eiche hell Lackiert oder in den angegebenen Farben. FüÙe aus Polypropylen.

1 box
2 u. x box
0,174 M³

8,00
11,00

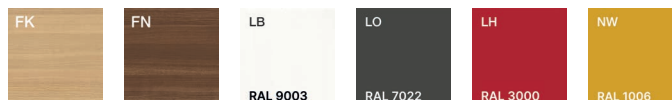

Depending on the surface the color may vary slightly from the reference (RAL / NCS) provided.

En fonction de la surface, la couleur peut varier légèrement par rapport à la référence (RAL / NCS) fournie.







Je nach Oberfläche kann die Farbe in Bezug auf die RAL/NCS Referenz abweichen.

CATAS EN 16139 Level 2 (Extreme use)

FINISH OPTIONS / FINITION / AUSFÜHRUNG

FK	FN	LB	NW	LH	LO
430 PTS	430 PTS	409 PTS	409 PTS	409 PTS	409 PTS



FRAME / CADRE / GESTELL

	Oak varnished solid ash wood Frêne massif verni chêne Esche massiv Eiche hell lackiert	FSFK5	=
	Walnut varnished solid ash wood Frêne massif verni noyer canaletto Esche massiv Nussbaum Kanaletto lackiert	FSFN5	=
	White varnished solid beech wood Hêtre massif verni blanc Buche massiv Weiss lackiert	FSBA5	=
	Anthracite varnished solid beech wood Hêtre massif verni gris ombre Buche massiv Dunkelgrau lackiert	FSGO5	=
	Red varnished solid beech wood Hêtre massif verni rouge Buche massiv Rot lackiert	FSRS5	=
	Ochre varnished solid beech wood Hêtre massif verni ocre Buche massiv Ocker lackiert	FSOC5	=

ACCESSORIES / ACCESSOIRES / ZUBEHÖR

	Nylon feet supplied with felt pads for wooden flooring Patins de feutres en nylon NylonfüÙe mit Filzgleiter	ACC10	+8 PTS
--	--	-------	--------

ON REQUEST ONLY / SUR REQUETE / AUF ANFRAGE

	<p>Powder coated shell in a special finish, 8-unit minimum order Coque en coloris spéciaux, à partir de 8 pièces Sitzschale: Sonderlackierung nach Kundenwunsch, ab 8 Stück</p> <p><small>Price on request for special varnish finishes / Pour vernis spécifiques, devis sur requête / Sonderlackfarben auf Anfrage</small></p>	<p>VERN</p>	<p>+28 PTS</p>
	<p>Powder coated frame in a special finish, 2-unit minimum order Cadre en coloris spéciaux, à partir de 2 pièces Gestell: Sonderlackierung nach Kundenwunsch, ab 2 Stück</p> <p><small>Price on request for special varnish finishes / Pour vernis spécifiques, devis sur requête / Sonderlackfarben auf Anfrage</small></p>	<p>VERN</p>	<p>+83 PTS</p>

Code wooden stool, 750mm high seat

Tabouret Code bois, H 75

Barhocker Code, H 75

CODE

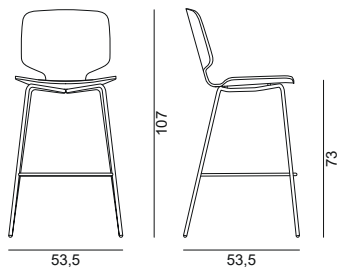

Cod. OCODES01

Beech plywood shell finished in lacquer or veneered and varnished in oak or walnut. 4-leg metal frame made from 2mm thick 16mmØ steel tube, in chrome. Polypropylene glides.

Coque laquée en multi-plis de hêtre ou bois placage finition frêne verni chêne ou noyer. Structure en tube d'acier D16mm ép.2mm chromé. Patins en polypropylène.

Sitzschale aus Buchensperrholz lackiert oder aus Eschenfurnier Eiche hell- oder Nussbaumfarbig-lackiert. Verchromter Ø 16mm 2mm starj Stahlrohrgestell. FüÙe aus Polypropylen.



1 box
1 u. x box
0,350 M³

6,50
10,00
KG

Depending on the surface the color may vary slightly from the reference (RAL / NCS) provided.
En fonction de la surface, la couleur peut varier légèrement par rapport à la référence (RAL / NCS) fournie.
Je nach Oberfläche kann die Farbe in Bezug auf die RAL/NCS Referenz abweichen.

FINISH OPTIONS / FINITION / AUSFÜHRUNG

FK	FN	LB	NW	LH	LO
358 PTS	358 PTS	338 PTS	338 PTS	338 PTS	338 PTS

FRAME / CADRE / GESTELL

	Chrome frame Cadre chromé Verchromtes Gestell	FSC21	=
--	--	-------	---

ACCESSORIES / ACCESSOIRES / ZUBEHÖR

	Set of silent anti-scratch felt pads and glides Kit de patins de feutres et patins anti-rayures et anti-bruit Kit kratzfesten und geräuschkämpfenden Filzgleiter.	ACC12	+19 PTS
--	--	-------	---------

ON REQUEST ONLY / SUR REQUETE / AUF ANFRAGE

	Bronze powder coated frame Structure vernie bronze Gestell Bronze lackiert	BR	+131 PTS
	Gold powder coated frame Structure vernie or Gestell Gold lackiert	OR	+131 PTS
	Corten powder coated frame Structure vernie corten Gestell Corten lackiert	CO	+131 PTS
	Powder coated shell in a special finish, 8-unit minimum order Coque en coloris spéciaux, à partir de 8 pièces Sitzschale: Sonderlackierung nach Kundenwunsch, ab 8 Stück Price on request for special varnish finishes / Pour vernis spécifiques, devis sur requête / Sonderlackfarben auf Anfrage	VERN	+28 PTS
	Powder coated frame in a special finish, 2-unit minimum order Cadre en coloris spéciaux, à partir de 2 pièces Gestell: Sonderlackierung nach Kundenwunsch, ab 2 Stück Price on request for special varnish finishes / Pour vernis spécifiques, devis sur requête / Sonderlackfarben auf Anfrage	VERN	+83 PTS

CODE

Code wooden chair, upholstered seat, 4 metal legs Chaise Code bois, assise tapissée, 4 pieds métal Code Stuhl Holz, gepolsterter Sitz, 4 Metallbeine

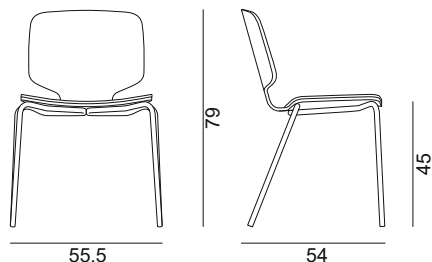

Cod. OCODEV11

Beech plywood shell finished in lacquer or veneered and varnished in oak or walnut. Fixed upholstered seat pad made from 20mm highly elastic cut-to-size polyurethane foam sheet. 4-leg metal frame made from 2mm thick 18mmØ steel tube, in chrome or epoxy powder coated. Polypropylene glides.

Coque laquée en multi-plis de hêtre ou bois placage finition frêne verni chêne ou noyer. Assise en polyuréthane expansée sélectionné par un bloc hautement élastique, ép. 20mm. Structure 4 pieds en tube d'acier D18mm ép.2mm chromé ou verni à poudre époxy. Patins en polypropylène.

Sitzschale aus Buchensperrholz lackiert oder aus Eschenfurnier Eiche hell- oder Nussbaumfarbig-lackiert. Sitz gepolstert mit hochelastischem Polyurethanschaum, der durch einen Block geteilt wird, Stärke 20 mm. 4 Bein-Gestell aus Stahlrohr Ø 18mm 2mm stark verchromt oder epoxydpulverbeschichtet. Füße aus Polypropylen.

1 box
2 u. x box
0,174 M³

KG 10,80
13,80

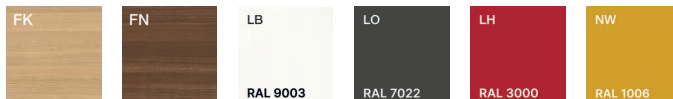

Depending on the surface the color may vary slightly from the reference (RAL / NCS) provided.

En fonction de la surface, la couleur peut varier légèrement par rapport à la référence (RAL / NCS) fournie.
Je nach Oberfläche kann die Farbe in Bezug auf die RAL/NCS Referenz abweichen.

UPHOLSTERY / REVETEMENT / BEZUG

B01/B03	C01/C05	D02/D03/D05	E01	P01
335 PTS	342 PTS	347 PTS	356 PTS	374 PTS

UPHOLSTERY ON REQUEST / REVETEMENT SUR REQUETE / ÜBERZUG AUF ANFRAGE

D04/D06	E02/E03/E04	I01/I02
347 PTS	356 PTS	384 PTS

FINISH OPTIONS / FINITION / AUSFÜHRUNG

FK	FN	LB	NW	LH	LO
+20 PTS	+20 PTS	=	=	=	=

FRAME / CADRE / GESTELL

	Chrome frame Cadre chromé Verchromtes Gestell	FSC25	=
	Powder coated frame in anthracite Cadre verni gris ombre Gestell Dunkelgrau lackiert	FST25	=





ACCESSORIES / ACCESSOIRES / ZUBEHÖR

	Set of silent anti-scratch felt pads and glides Kit de patins de feutres et patins anti-rayures et anti-bruit Kit kratzfesten und geräuschkämpfenden Filzgleiter.	ACC13	+19 PTS
---	--	-------	---------

Code wooden chair, upholstered seat, 4 metal legs

Chaise Code bois, assise tapissée, 4 pieds métal

Code Stuhl Holz, gepolsterter Sitz, 4 Metallbeine

ON REQUEST ONLY / SUR REQUETE / AUF ANFRAGE		
	Bronze powder coated frame Structure vernie bronze Gestell Bronze lackiert	BR +131 PTS
	Gold powder coated frame Structure vernie or Gestell Gold lackiert	OR +131 PTS
	Corten powder coated frame Structure vernie corten Gestell Corten lackiert	CO +131 PTS
	Powder coated shell in a special finish, 8-unit minimum order Coque en coloris spéciaux, à partir de 8 pièces Sitzschale: Sonderlackierung nach Kundenwunsch, ab 8 Stück <small>Price on request for special varnish finishes / Pour vernis spécifiques, devis sur requête / Sonderlackfarben auf Anfrage</small>	VERN +28 PTS
	Powder coated frame in a special finish, 6-unit minimum order Cadre en coloris spéciaux, à partir de 6 pièces Gestell: Sonderlackierung nach Kundenwunsch, ab 6 Stück <small>Price on request for special varnish finishes / Pour vernis spécifiques, devis sur requête / Sonderlackfarben auf Anfrage</small>	VERN +83 PTS

CODE

Code wooden chair, upholstered seat, sled base in metal Chaise Code bois, assise tapissée, luge métal Code-Stuhl Holz, gepolsterter Sitz, Metallschlitzen

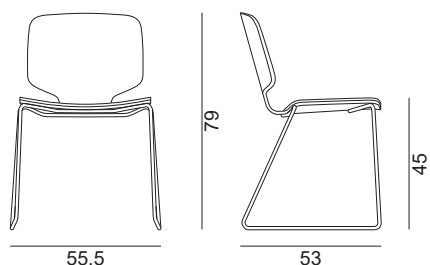

1 box
2 u. x box
0,174 M³

KG 15,40
18,40

Cod. OCODEV12

Beech plywood shell finished in lacquer or veneered and varnished in oak or walnut. Fixed upholstered seat pad made from 20mm highly elastic cut-to-size polyurethane foam sheet. Sled base made from 12mmØ chromed steel rod. Polyethylene glides.

Coque laquée en multi-plis de hêtre ou bois placage finition frêne verni chêne ou noyer. Assise en polyuréthane expansée sélectionné par un bloc hautement élastique, ép. 20mm. Structure en tube d'acier D12 chromé. Patins en polyéthylène.

Sitzschale aus Buchensperrholz lackiert oder aus Eschenfurnier Eiche hell- oder Nussbaumfarbig-lackiert. Sitz gepolstert mit hochelastischem Polyurethanschaum, der durch einen Block geteilt wird, Stärke 20 mm. Verchromter Ø 12 mm Stahlgestell. FüÙe aus Polyethylen.

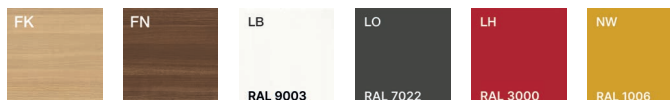

Depending on the surface the color may vary slightly from the reference (RAL / NCS) provided.
En fonction de la surface, la couleur peut varier légèrement par rapport à la référence (RAL / NCS) fournie.
Je nach Oberfläche kann die Farbe in Bezug auf die RAL/NCS Referenz abweichen.

UPHOLSTERY / REVETEMENT / BEZUG

B01/B03	C01/C05	D02/D03/D05	E01	P01
339 PTS	343 PTS	353 PTS	360 PTS	383 PTS

UPHOLSTERY ON REQUEST / REVETEMENT SUR REQUETE / ÜBERZUG AUF ANFRAGE

D04/D06	E02/E03/E04	I01/I02
353 PTS	360 PTS	388 PTS



FINISH OPTIONS / FINITION / AUSFÜHRUNG

FK	FN	LB	NW	LH	LO
+20 PTS	+20 PTS	=	=	=	=

FRAME / CADRE / GESTELL

	Chrome frame Cadre chromé Verchromtes Gestell	FSC26	=
---	--	-------	---



ON REQUEST ONLY / SUR REQUETE / AUF ANFRAGE

	Bronze powder coated frame Structure vernie bronze Gestell Bronze lackiert	BR	+131 PTS
	Gold powder coated frame Structure vernie or Gestell Gold lackiert	OR	+131 PTS
	Corten powder coated frame Structure vernie corten Gestell Corten lackiert	CO	+131 PTS

Code wooden chair, upholstered seat, sled base in metal

Chaise Code bois, assise tapissée, luge métal

Code-Stuhl Holz, gepolsterter Sitz, Metallschlitten

ON REQUEST ONLY / SUR REQUETE / AUF ANFRAGE		
	<p>Powder coated shell in a special finish, 8-unit minimum order Coque en coloris spéciaux, à partir de 8 pièces Sitzschale: Sonderlackierung nach Kundenwunsch, ab 8 Stück</p> <p><small>Price on request for special varnish finishes / Pour vernis spécifiques, devis sur requête / Sonderlackfarben auf Anfrage</small></p>	<p>VERN +28 PTS</p>
	<p>Powder coated frame in a special finish, 6-unit minimum order Cadre en coloris spéciaux, à partir de 6 pièces Gestell: Sonderlackierung nach Kundenwunsch, ab 6 Stück</p> <p><small>Price on request for special varnish finishes / Pour vernis spécifiques, devis sur requête / Sonderlackfarben auf Anfrage</small></p>	<p>VERN +83 PTS</p>

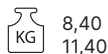
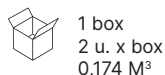
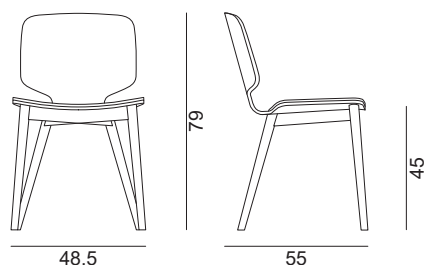

Cod. OCODEV13

Beech plywood shell finished in lacquer or veneered and varnished in oak or walnut. Fixed upholstered seat pad made from 20mm highly elastic cut-to-size polyurethane foam sheet. 4-leg frame made from tapered ash solid wood, 36mmØ max/24mmØ min. varnished in oak or walnut finish or lacquered in the shown colours. Polypropylene glides.

Coque laquée en multi-plis de hêtre ou bois placage finition frêne verni chêne ou noyer. Assise en polyuréthane expansée sélectionné par un bloc hautement élastique, ép. 20mm. Structure en frêne massif diamètre variable da D36 à D24mm. verni chêne ou dans les coloris indiqués. Patins en polypropylène.

Sitzschale aus Buchensperrholz lackiert oder aus Eiche hell- oder Nussbaumfarbig-lackiert. Sitz gepolstert mit hochelastischem Polyurethanschaum, der durch einen Block geteilt wird, Stärke 20 mm. Gestell aus massivem Eschenholz mit variablem Durchmesser, der sich von Ø 36 auf Ø 24 mm verjüngt. Natur Lackiert oder in den angegebenen Farben. Füße aus Polypropylen.

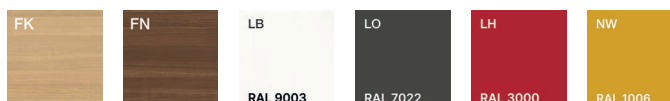

Depending on the surface the color may vary slightly from the reference (RAL / NCS) provided.
En fonction de la surface, la couleur peut varier légèrement par rapport à la référence (RAL / NCS) fournie.
Je nach Oberfläche kann die Farbe in Bezug auf die RAL/NCS Referenz abweichen.

CATAS EN 16139 Level 2 (Extreme use)

UPHOLSTERY / REVETEMENT / BEZUG

B01/B03	C01/C05	D02/D03/D05	E01	P01
461 PTS	467 PTS	472 PTS	481 PTS	500 PTS





UPHOLSTERY ON REQUEST / REVETEMENT SUR REQUETE / ÜBERZUG AUF ANFRAGE

D04/D06	E02/E03/E04	I01/I02
472 PTS	481 PTS	510 PTS

FINISH OPTIONS / FINITION / AUSFÜHRUNG

FK	FN	LB	NW	LH	LO
+20 PTS	+20 PTS	=	=	=	=





FRAME / CADRE / GESTELL

	Oak varnished solid ash wood Frêne massif verni chêne Esche massiv Eiche hell lackiert	FSFK5	=
	Walnut varnished solid ash wood Frêne massif verni noyer canaletto Esche massiv Nussbaum Kanaletto lackiert	FSFN5	=
	White varnished solid beech wood Hêtre massif verni blanc Buche massiv Weiss lackiert	FSBA5	=
	Anthracite varnished solid beech wood Hêtre massif verni gris ombre Buche massiv Dunkelgrau lackiert	FSGO5	=

Code wooden chair, upholstered seat, 4 wooden legs

Chaise Code bois, assise tapissée, 4 pieds bois

Code Stuhl Holz, gepolsterter Sitz, 4 Holzbeine

FRAME / CADRE / GESTELL			
	Red varnished solid beech wood Hêtre massif verni rouge <i>Buche massiv Rot lackiert</i>	FSRS5	=
	Ochre varnished solid beech wood Hêtre massif verni ocre <i>Buche massiv Ocker lackiert</i>	FSOC5	=
ACCESSORIES / ACCESSOIRES / ZUBEHÖR			
	Nylon feet supplied with felt pads for wooden flooring Patins de feutres en nylon <i>Nylonfüße mit Filzgleiter</i>	ACC10	+8 PTS
ON REQUEST ONLY / SUR REQUETE / AUF ANFRAGE			
	Powder coated shell in a special finish, 8-unit minimum order Coque en coloris spéciaux, à partir de 8 pièces <i>Sitzschale: Sonderlackierung nach Kundenwunsch, ab 8 Stück</i> <small>Price on request for special varnish finishes / Pour vernis spécifiques, devis sur requête / Sonderlackfarben auf Anfrage</small>	VERN	+28 PTS
	Powder coated frame in a special finish, 2-unit minimum order Cadre en coloris spéciaux, à partir de 2 pièces <i>Gestell: Sonderlackierung nach Kundenwunsch, ab 2 Stück</i> <small>Price on request for special varnish finishes / Pour vernis spécifiques, devis sur requête / Sonderlackfarben auf Anfrage</small>	VERN	+83 PTS

CODE

Code wooden stool, upholstered seat, 750mm high seat Tabouret Code bois, assise tapissée, H 75 Barhocker Code, gepolsterter Sitz, H 75

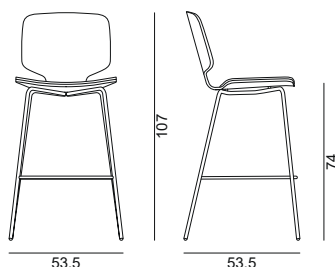

1 box
1 u. x box
0,350 M³



6,70
10,20

Cod. OCODES11

Beech plywood shell finished in lacquer or veneered and varnished in oak or walnut. Fixed upholstered seat pad made from 20mm highly elastic cut-to-size polyurethane foam sheet. 4-leg metal frame made from 2mm thick 16mmØ steel tube, in chrome. Polypropylene glides.

Coque laquée en multi-plis de hêtre ou bois placage finition frêne verni chêne ou noyer. Assise en polyuréthane expansée sélectionné par un bloc hautement élastique, ép. 20mm. Structure en tube d'acier D16mm ép.2mm chromé. Patins en polypropylène.

Sitzschale aus Buchensperrholz lackiert oder aus Eschenfurnier Eiche hell- oder Nussbaumfarbig-lackiert. Sitz gepolstert mit hochelastischem Polyurethanschaum, der durch einen Block geteilt wird, Stärke 20 mm. Verchromter Stahlrohrgestell Ø 16mm 2mm stark. FüÙe aus Polypropylen.

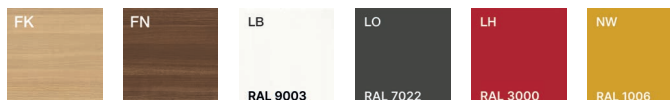

Depending on the surface the color may vary slightly from the reference (RAL / NCS) provided.
En fonction de la surface, la couleur peut varier légèrement par rapport à la référence (RAL / NCS) fournie.
Je nach Oberfläche kann die Farbe in Bezug auf die RAL/NCS Referenz abweichen.

UPHOLSTERY / REVETEMENT / BEZUG

B01/B03	C01/C05	D02/D03/D05	E01	P01
389 PTS	398 PTS	402 PTS	409 PTS	431 PTS

UPHOLSTERY ON REQUEST / REVETEMENT SUR REQUETE / ÜBERZUG AUF ANFRAGE

D04/D06	E02/E03/E04	I01/I02
402 PTS	409 PTS	437 PTS

FINISH OPTIONS / FINITION / AUSFÜHRUNG

FK	FN	LB	NW	LH	LO
+20 PTS	+20 PTS	=	=	=	=

FRAME / CADRE / GESTELL

	Chrome frame Cadre chromé Verchromtes Gestell	FSC21	=
---	--	-------	---

ACCESSORIES / ACCESSOIRES / ZUBEHÖR

	Set of silent anti-scratch felt pads and glides Kit de patins de feutres et patins anti-rayures et anti-bruit Kit kratzfesten und geräuschkämpfenden Filzgleiter.	ACC12	+19 PTS
---	--	-------	---------



ON REQUEST ONLY / SUR REQUETE / AUF ANFRAGE

	Bronze powder coated frame Structure vernie bronze Gestell Bronze lackiert	BR	+131 PTS
---	---	----	----------

Code wooden stool, upholstered seat, 750mm high seat

Tabouret Code bois, assise tapissée, H 75

Barhocker Code, gepolsterter Sitz, H 75

ON REQUEST ONLY / SUR REQUETE / AUF ANFRAGE			
	Gold powder coated frame Structure vernie or Gestell Gold lackiert	OR	+131 PTS
	Corten powder coated frame Structure vernie corten Gestell Corten lackiert	CO	+131 PTS
	Powder coated shell in a special finish, 8-unit minimum order Coque en coloris spéciaux, à partir de 8 pièces Sitzschale: Sonderlackierung nach Kundenwunsch, ab 8 Stück <small>Price on request for special varnish finishes / Pour vernis spécifiques, devis sur requête / Sonderlackfarben auf Anfrage</small>	VERN	+28 PTS
	Powder coated frame in a special finish, 2-unit minimum order Cadre en coloris spéciaux, à partir de 2 pièces Gestell: Sonderlackierung nach Kundenwunsch, ab 2 Stück <small>Price on request for special varnish finishes / Pour vernis spécifiques, devis sur requête / Sonderlackfarben auf Anfrage</small>	VERN	+83 PTS

COVE

FULL POLYPROPYLENE SHELL
COQUE EN POLYPROPYLÈNE
SCHALE AUS POLYPROPYLEN

Cove polypropylene chair, 4 metal legs
Chaise en polypropylène Cove, 4 pieds métal
Cove Stuhl Polypropylen, 4-Fuß Gestell Metall

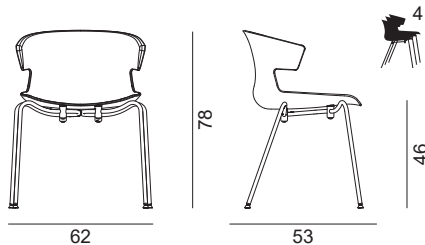

1 box
2 u. x box
0,170 M³

KG 10,00
12,00

Cod. OCOVEV01

8mm polypropylene shell; frame made from Ø16mm highly resilient steel tube; polyethylene glides; spacers on the underside of the seat covered with protective rubber for stacking.

Coque en polypropylène ép. 8mm; cadre en tube d'acier à haute résistance Ø16mm; patins en polyéthylène; entretoises de protection en caoutchouc pour empilabilité.

Schale aus Polypropylen, Stärke 8 mm; Rahmen aus hochfestem Stahlrohr, Ø16 mm; Füße aus Polyethylen; Abstandshalter mit Schutzgummi für Stapelbarkeit.

BA RAL 9003	BG NCS S 4010 Y30R	GR PANTONE 421	GO RAL 7022	OC NSC S 2060 Y20R	AB NCS S 4040 Y50R	VD NCS S 6020 G70Y	BT NCS S 5030 R80B
TM RAL 8014							

Depending on the surface the color may vary slightly from the reference (RAL / NCS) provided.
En fonction de la surface, la couleur peut varier légèrement par rapport à la référence (RAL / NCS) fournie.
Je nach Oberfläche kann die Farbe in Bezug auf die RAL/NCS Referenz abweichen.

CATAS UNI EN 16139 Level 1, UNI EN 1022, UNI EN 1728

FRAME / CADRE / GESTELL

	Chrome frame Cadre chromé Verchromtes Gestell	FSC11	166 PTS
	Powder coated frame in silver Cadre verni alu Gestell Aluminium lackiert	FSG11	166 PTS
	Powder coated frame in white Cadre verni blanc Gestell Weiß lackiert	FSB11	166 PTS
	Powder coated frame in anthracite Cadre verni gris ombre Gestell Dunkelgrau lackiert	FST11	166 PTS







ACCESSORIES / ACCESSOIRES / ZUBEHÖR

	B01/B03 fabric/faux leather upholstered small soft pad in the shown colors Coussin revêtu en tissu/textile enduit B01/B03 (dans les revêtements indiqués) Gepolstertes Kissen mit Stoff/Kunstleder Kat. B01/B03 bezogen (in den angegebenen Farben)	CU1B	+46 PTS			
<p>B01: 009 / 010 / 012 / 013 / 018 / 023 / 027 / 028 / 222 B03: 138 / 175 / 176 / 180 / 183 / 184 / 185 / 186</p> <p>B01 & B03 finishes which do not show are available on request, 12 unit minimum order: further +17 pts upcharge / Les revêtements B01 et B03 non indiqués, sont disponibles sur requête, min. 12 pièces: +17 pts / Die Farben aus der Kategorie B01 bzw. B03, die hier nicht angegeben sind, sind auf Anfrage erhältlich, ab 12 Stück: + 17 Pkte</p>						
	Upholstered large soft pad Assise rembourrée Gepolsterter Sitz	B01/B03 CU2B	C01/C05 CU2C	D02/D03 CU2D	E01 CU2E	P01 CU2P
		+113 PTS	+123 PTS	+144 PTS	+157 PTS	+177 PTS
	Padded seat, upholstery on request Assise rembourrée, revêtement sur demande Gepolsterter Sitz; Überzug auf Anfrage		D04/D06 CU2D	E02/E03 CU2E	I01/102 CU2I	M02/M03 CU2M
			+144 PTS	+157 PTS	+204 PTS	+231 PTS
	Articulating adjustable feet complete with felt pads Patins feutrés dénoués Gelenkfüße mit Filzgleiter	PD001	+20 PTS			

Cove polypropylene chair, 4 metal legs
 Chaise en polypropylène Cove, 4 pieds métal
 Cove Stuhl Polypropylen, 4-Fuß Gestell Metall

COVE

FULL POLYPROPYLENE SHELL
 COQUE EN POLYPROPYLENE
 SCHALE AUS POLYPROPYLEN

ACCESSORIES / ACCESSOIRES / ZUBEHÖR		
	<p>Set of silent anti-scratch felt pads and glides Kit de patins de feutres et patins anti-rayures et anti-bruit Kit kratzfesten und geräuschdämpfenden Filzgleiter.</p>	<p>ACC12 +17 PTS</p>
ON REQUEST ONLY / SUR REQUETE / AUF ANFRAGE		
	<p>Fire retardant shell, 300-unit minimum order in one color Version non-feu, à partir de 300 pièces Feuerfeste Ausführung, mindestens 300 Schalen pro Farbe</p>	<p>IGNI +28 PTS</p>
	<p>Gold powder coated frame Structure vernie or Gestell Gold lackiert</p>	<p>OR +131 PTS</p>
	<p>Bronze powder coated frame Structure vernie bronze Gestell Bronze lackiert</p>	<p>BR +131 PTS</p>
	<p>Corten powder coated frame Structure vernie corten Gestell Corten lackiert</p>	<p>CO +131 PTS</p>
	<p>Powder coated frame in a special finish, 6-unit minimum order Cadre en coloris spéciaux, à partir de 6 pièces Gestell: Sonderlackierung nach Kundenwunsch, ab 6 Stück Price on request for special varnish finishes / Pour vernis spécifiques, devis sur requête / Sonderlackfarben auf Anfrage</p>	<p>VERN +83 PTS</p>

COVE

FULL POLYPROPYLENE SHELL
COQUE EN POLYPROPYLÈNE
SCHALE AUS POLYPROPYLEN

Cove polypropylene chair, sled metal base Chaise en polypropylène Cove, luge métal Cove Stuhl Polypropylen, Schlittengestell Metall

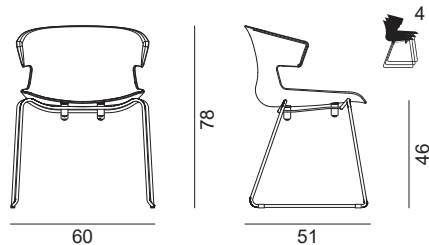

1 box
2 u. x box
0,170 M³

KG 12,00
14,00

Cod. OCOVEV02

8mm polypropylene shell; frame made from Ø11mm steel tube; polyethylene glides; spacers on the underside of the seat covered with protective rubber for stacking.

Coque en polypropylène ép.8 mm; cadre en tube d'acier Ø11mm; patins en polyéthylène; entretoises de protection en caoutchouc pour empilabilité.

8 mm Stärker Polypropylenmantel; Stahlrohrrahmen Ø11 mm; Polyethylenfüße; Abstandhalter mit Schutzdichtungen für Stapelbarkeit.

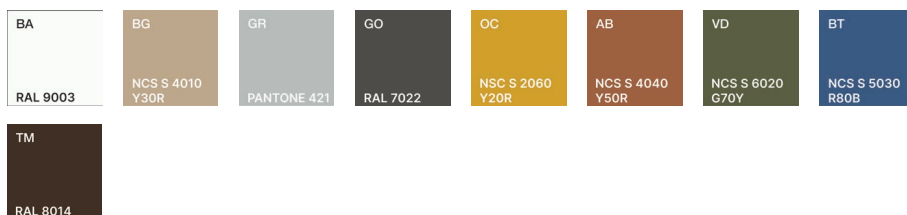

Depending on the surface the color may vary slightly from the reference (RAL / NCS) provided.
En fonction de la surface, la couleur peut varier légèrement par rapport à la référence (RAL / NCS) fournie.
Je nach Oberfläche kann die Farbe in Bezug auf die RAL/NCS Referenz abweichen.

FRAME / CADRE / GESTELL

	Chrome frame Cadre chromé Verchromtes Gestell	FSC12	183 PTS
	Powder coated frame in silver Cadre verni alu Gestell Aluminium lackiert	FSG12	183 PTS
	Powder coated frame in white Cadre verni blanc Gestell Weiß lackiert	FSB12	183 PTS
	Powder coated frame in anthracite Cadre verni gris ombre Gestell Dunkelgrau lackiert	FST12	183 PTS





ACCESSORIES / ACCESSOIRES / ZUBEHÖR

	B01/B03 fabric/faux leather upholstered small soft pad in the shown colors Coussin revêtu en tissu/textile enduit B01/B03 (dans les revêtements indiqués) Gepolstertes Kissen mit Stoff/Kunstleder Kat. B01/B03 bezogen (in den angegebenen Farben)	CU1B	+46 PTS										
<p>B01: 009 / 010 / 012 / 013 / 018 / 023 / 027 / 028 / 222 B03: 138 / 175 / 176 / 180 / 183 / 184 / 185 / 186</p> <p><small>B01 & B03 finishes which do not show are available on request, 12 unit minimum order: further +17 pts upcharge / Les revêtements B01 et B03 non indiqués, sont disponibles sur requête, min. 12 pièces: +17 pts / Die Farben aus der Kategorie B01 bzw. B03, die hier nicht angegeben sind, sind auf Anfrage erhältlich, ab 12 Stück: + 17 Pkte</small></p>													
	Upholstered large soft pad Assise rembourrée Gepolsterter Sitz	<table border="1"> <tr> <td>B01/B03 CU2B</td> <td>C01/C05 CU2C</td> <td>D02/D03 CU2D</td> <td>E01 CU2E</td> <td>P01 CU2P</td> </tr> <tr> <td>+113 PTS</td> <td>+123 PTS</td> <td>+144 PTS</td> <td>+157 PTS</td> <td>+177 PTS</td> </tr> </table>	B01/B03 CU2B	C01/C05 CU2C	D02/D03 CU2D	E01 CU2E	P01 CU2P	+113 PTS	+123 PTS	+144 PTS	+157 PTS	+177 PTS	
B01/B03 CU2B	C01/C05 CU2C	D02/D03 CU2D	E01 CU2E	P01 CU2P									
+113 PTS	+123 PTS	+144 PTS	+157 PTS	+177 PTS									
	Padded seat, upholstery on request Assise rembourrée, revêtement sur demande Gepolsterter Sitz; Überzug auf Anfrage	<table border="1"> <tr> <td>D04/D06 CU2D</td> <td>E02/E03 CU2E</td> <td>I01/I02 CU2I</td> <td>M02/M03 CU2M</td> </tr> <tr> <td>+144 PTS</td> <td>+157 PTS</td> <td>+204 PTS</td> <td>+231 PTS</td> </tr> </table>	D04/D06 CU2D	E02/E03 CU2E	I01/I02 CU2I	M02/M03 CU2M	+144 PTS	+157 PTS	+204 PTS	+231 PTS			
D04/D06 CU2D	E02/E03 CU2E	I01/I02 CU2I	M02/M03 CU2M										
+144 PTS	+157 PTS	+204 PTS	+231 PTS										
	Linking device Accrochage pour chaises Verbinder für Stühle	ACC07	+2 PTS										

Cove polypropylene chair, sled metal base
 Chaise en polypropylène Cove, luge métal
 Cove Stuhl Polypropylen, Schlittengestell Metall

COVE

FULL POLYPROPYLENE SHELL
 COQUE EN POLYPROPYLENE
 SCHALE AUS POLYPROPYLEN

ON REQUEST ONLY / SUR REQUETE / AUF ANFRAGE		
	Fire retardant shell, 300-unit minimum order in one color Version non-feu, à partir de 300 pièces Feuerfeste Ausführung, mindestens 300 Schalen pro Farbe	IGNI +28 PTS
	Gold powder coated frame Structure vernie or Gestell Gold lackiert	OR +131 PTS
	Bronze powder coated frame Structure vernie bronze Gestell Bronze lackiert	BR +131 PTS
	Corten powder coated frame Structure vernie corten Gestell Corten lackiert	CO +131 PTS
	Powder coated frame in a special finish, 6-unit minimum order Cadre en coloris spéciaux, à partir de 6 pièces Gestell: Sonderlackierung nach Kundenwunsch, ab 6 Stück <small>Price on request for special varnish finishes / Pour vernis spécifiques, devis sur requête / Sonderlackfarben auf Anfrage</small>	VERN +83 PTS

COVE

FULL POLYPROPYLENE SHELL
COQUE EN POLYPROPYLÈNE
SCHALE AUS POLYPROPYLEN

Cove polypropylene chair, 4 wooden legs
Chaise en polypropylène Cove, 4 pieds bois
Cove Stuhl Polypropylen, 4-Fuß Gestell aus Holz

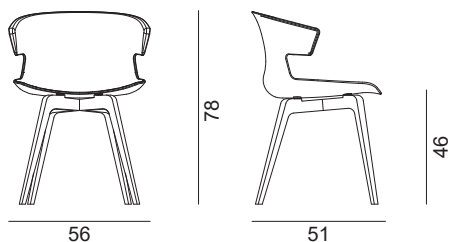

Cod. OCOVEV03

8mm polypropylene shell; base made from varnished solid beech wood; nylon glides.

Coque en polypropylène ép. 8mm; structure en hêtre massif verni; patins en nylon.

Polypropylenschale, Stärke 8mm; Rahmen aus lackierter massiver Buche; Füße aus Nylon.

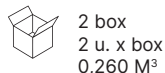

2 box
2 u. x box
0,260 M³



10,00
12,00



Depending on the surface the color may vary slightly from the reference (RAL / NCS) provided.

En fonction de la surface, la couleur peut varier légèrement par rapport à la référence (RAL / NCS) fournie.





Je nach Oberfläche kann die Farbe in Bezug auf die RAL/NCS Referenz abweichen.

CATAS EN 16139 Level 1

FRAME / CADRE / GESTELL

	Oak varnished solid ash wood Frêne massif verni chêne Esche massiv Eiche hell lackiert	FSFK1	335 PTS
	Walnut varnished solid ash wood Frêne massif verni noyer canaletto Esche massiv Nussbaum Kanaletto lackiert	FSFN1	335 PTS

ACCESSORIES / ACCESSOIRES / ZUBEHÖR

	B01/B03 fabric/faux leather upholstered small soft pad in the shown colors Coussin revêtu en tissu/textile enduit B01/B03 (dans les revêtements indiqués) Gepolstertes Kissen mit Stoff/Kunstleder Kat. B01/B03 bezogen (in den angegebenen Farben)	CU1B	+46 PTS			
	B01: 009 / 010 / 012 / 013 / 018 / 023 / 027 / 028 / 222 B03: 138 / 175 / 176 / 180 / 183 / 184 / 185 / 186	<small>B01 & B03 finishes which do not show are available on request, 12 unit minimum order: further +17 pts upcharge / Les revêtements B01 et B03 non indiqués, sont disponibles sur requête, min. 12 pièces: +17 pts / Die Farben aus der Kategorie B01 bzw. B03, die hier nicht angegeben sind, sind auf Anfrage erhältlich, ab 12 Stück: + 17 Pkte</small>				
	Upholstered large soft pad Assise rembourrée Gepolsterter Sitz	B01/B03 CU2B	C01/C05 CU2C	D02/D03 CU2D	E01 CU2E	P01 CU2P
		+113 PTS	+123 PTS	+144 PTS	+157 PTS	+177 PTS
	Padded seat, upholstery on request Assise rembourrée, revêtement sur demande Gepolsterter Sitz; Überzug auf Anfrage	D04/D06 CU2D	E02/E03 CU2E	I01/102 CU2I	M02/M03 CU2M	
		+144 PTS	+157 PTS	+204 PTS	+231 PTS	
	Nylon feet supplied with felt pads for wooden flooring Patins de feutres en nylon Nylonfüße mit Filzgleiter	ACC10	+8 PTS			

ON REQUEST ONLY / SUR REQUETE / AUF ANFRAGE

	Powder coated frame in a special finish, 10-unit minimum order Cadre en coloris spéciaux, à partir de 10 pièces Gestell: Sonderlackierung nach Kundenwunsch, ab 10 Stück	VERN	+41 PTS
	<small>Price on request for special varnish finishes / Pour vernis spécifiques, devis sur requête / Sonderlackfarben auf Anfrage</small>		

Cove polypropylene chair, spider swivel frame

Chaise en polypropylène Cove, piètement étoile pivotant

Cove Stuhl Polypropylen, 4-Fuß Designgestell, drehbar

FULL POLYPROPYLENE SHELL
COQUE EN POLYPROPYLÈNE
SCHALE AUS POLYPROPYLEN

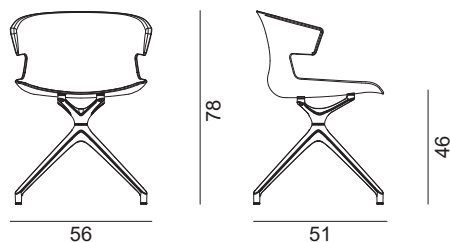

Cod. OCOVEV04

8mm polypropylene shell; Ø700mm powder coated die-cast aluminium swivel frame; no gas lift; silent nylon glides for carpet or hard flooring.

Coque en polypropylène ép.8 mm; piètement Ø700mm en alu verni; vérin pivotant sans lift; patins en nylon avec accessoire de glissement sur moquette inclus.

Sitzschale aus Polypropylen, Stärke 8 mm; Sockel Ø700 mm aus lackiertem Aluminiumdruckguss; Drehlift ohne Höhenverstellung; Nylonfüße mit Zubehör zum Aufschieben auf Teppiche inklusive.

2 box
2 u. x box
0,250 M³

14,00
16,00

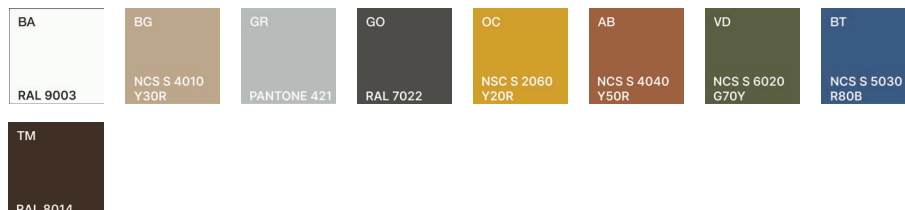

Depending on the surface the color may vary slightly from the reference (RAL / NCS) provided.
En fonction de la surface, la couleur peut varier légèrement par rapport à la référence (RAL / NCS) fournie.
Je nach Oberfläche kann die Farbe in Bezug auf die RAL/NCS Referenz abweichen.

BASE / BASE / GESTELL

	Powder coated aluminium spider base in silver Piètement 4 branches en alu verni alu avec plaque en teinte 4-Sternfußkreuz Alu pulverbeschichtet mit Unterplatte in gleicher Farbe	BAA08	356 PTS
	Powder coated aluminium spider base in white Piètement 4 branches en alu verni blanc avec plaque en teinte 4-Sternfußkreuz Weiß pulverbeschichtet mit Unterplatte in gleicher Farbe	BAA09	356 PTS
	Powder coated aluminium spider base in anthracite Piètement 4 branches en alu verni gris ombre avec plaque en teinte 4-Sternfußkreuz Dunkelgrau pulverbeschichtet mit Unterplatte in gleicher Farbe	BAA14	356 PTS

ACCESSORIES / ACCESSOIRES / ZUBEHÖR

	B01/B03 fabric/faux leather upholstered small soft pad in the shown colors Coussin revêtu en tissu/textile enduit B01/B03 (dans les revêtements indiqués) Gepolstertes Kissen mit Stoff/Kunstleder Kat. B01/B03 bezogen (in den angegebenen Farben)	CU1B	+46 PTS										
<p>B01: 009 / 010 / 012 / 013 / 018 / 023 / 027 / 028 / 222 B03: 138 / 175 / 176 / 180 / 183 / 184 / 185 / 186</p> <p><small>B01 & B03 finishes which do not show are available on request, 12 unit minimum order: furter +17 pts upcharge / Les revêtements B01 et B03 non indiqués, sont disponibles sur requête, min. 12 pièces: +17 pts / Die Farben aus der Kategorie B01 bzw. B03, die hier nicht angegeben sind, sind auf Anfrage erhältlich, ab 12 Stück: +17 Pkte</small></p>													
	Upholstered large soft pad Assise rembourrée Gepolsterter Sitz	<table border="1"> <tr> <td>B01/B03 CU2B</td> <td>C01/C05 CU2C</td> <td>D02/D03 CU2D</td> <td>E01 CU2E</td> <td>P01 CU2P</td> </tr> <tr> <td>+113 PTS</td> <td>+123 PTS</td> <td>+144 PTS</td> <td>+157 PTS</td> <td>+177 PTS</td> </tr> </table>	B01/B03 CU2B	C01/C05 CU2C	D02/D03 CU2D	E01 CU2E	P01 CU2P	+113 PTS	+123 PTS	+144 PTS	+157 PTS	+177 PTS	
B01/B03 CU2B	C01/C05 CU2C	D02/D03 CU2D	E01 CU2E	P01 CU2P									
+113 PTS	+123 PTS	+144 PTS	+157 PTS	+177 PTS									
	Padded seat, upholstery on request Assise rembourrée, revêtement sur demande Gepolsterter Sitz; Überzug auf Anfrage	<table border="1"> <tr> <td>D04/D06 CU2D</td> <td>E02/E03 CU2E</td> <td>I01/102 CU2I</td> <td>M02/M03 CU2M</td> </tr> <tr> <td>+144 PTS</td> <td>+157 PTS</td> <td>+204 PTS</td> <td>+231 PTS</td> </tr> </table>	D04/D06 CU2D	E02/E03 CU2E	I01/102 CU2I	M02/M03 CU2M	+144 PTS	+157 PTS	+204 PTS	+231 PTS			
D04/D06 CU2D	E02/E03 CU2E	I01/102 CU2I	M02/M03 CU2M										
+144 PTS	+157 PTS	+204 PTS	+231 PTS										
	Felt pads Patins de feutre Filzgleiter	ACC14	+2 PTS										

ON REQUEST ONLY / SUR REQUETE / AUF ANFRAGE

	Fire retardant shell, 300-unit minimum order in one color Version non-feu, à partir de 300 pièces Feuerfeste Ausführung, mindestens 300 Schalen pro Farbe	IGNI	+28 PTS
--	--	-------------	---------

COVE

FULL POLYPROPYLENE SHELL
COQUE EN POLYPROPYLÈNE
SCHALE AUS POLYPROPYLEN

Cove polypropylene chair, 5-star swivel frame on castors Chaise en polypropylène Cove, base pivotante 5 branches sur roulettes Cove Stuhl Polypropylen, 5 Sternfuß auf Rollen

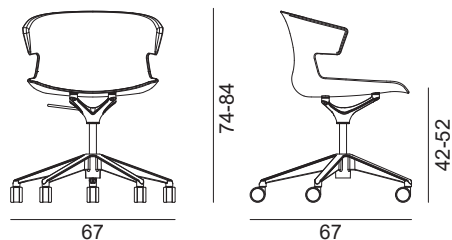

Cod. OCOVEA01

8mm polypropylene shell; aluminium plate under the seat; gas lift.

Coque en polypropylène ép. 8mm; plaque en alu; gas lift.

Sitzschale aus Polypropylen, Stärke 8 mm; Aluminiumplatte; Gasfeder.



1 box
1 u. x box
0,150 M³

7,00
9,00

Depending on the surface the color may vary slightly from the reference (RAL / NCS) provided.

En fonction de la surface, la couleur peut varier légèrement par rapport à la référence (RAL / NCS) fournie.

Je nach Oberfläche kann die Farbe in Bezug auf die RAL/NCS Referenz abweichen.

CATAS EN 16139 Level 1

BASE / BASE / GESTELL

	Powder coated aluminium 5-star base, silver finish Piètement 5 branches en alu avec plaque en teinte 5-Sternfußkreuz aus Aluminium, Ausführung Silber pulverbeschichtet	BAA10	321 PTS
	Powder coated aluminium 5-star base, white finish Piètement 5 branches en alu verni blanc avec plaque en teinte 5-Sternfußkreuz aus Aluminium, Ausführung Weiß pulverbeschichtet	BAA11	321 PTS
	Powder coated aluminium 5-star base, anthracite finish Piètement 5 branches en alu verni gris ombre avec plaque en teinte 5-Sternfußkreuz aus Aluminium, Ausführung Dunkelgrau pulverbeschichtet	BAA15	321 PTS

ACCESSORIES / ACCESSOIRES / ZUBEHÖR

	B01/B03 fabric/faux leather upholstered small soft pad in the shown colors Coussin revêtu en tissu/textile enduit B01/B03 (dans les revêtements indiqués) Gepolstertes Kissen mit Stoff/Kunstleder Kat. B01/B03 bezogen (in den angegebenen Farben)	CU1B	+46 PTS										
B01: 009 / 010 / 012 / 013 / 018 / 023 / 027 / 028 / 222 B03: 138 / 175 / 176 / 180 / 183 / 184 / 185 / 186		B01 & B03 finishes which do not show are available on request, 12 unit minimum order: further +17 pts upcharge / Les revêtements B01 et B03 non indiqués, sont disponibles sur requête, min. 12 pièces: +17 pts / Die Farben aus der Kategorie B01 bzw. B03, die hier nicht angegeben sind, sind auf Anfrage erhältlich, ab 12 Stück: + 17 Pkte											
	Upholstered large soft pad Assise rembourrée Gepolsterter Sitz	<table border="1"> <tr> <td>B01/B03 CU2B</td> <td>C01/C05 CU2C</td> <td>D02/D03 CU2D</td> <td>E01 CU2E</td> <td>P01 CU2P</td> </tr> <tr> <td>+113 PTS</td> <td>+123 PTS</td> <td>+144 PTS</td> <td>+157 PTS</td> <td>+177 PTS</td> </tr> </table>	B01/B03 CU2B	C01/C05 CU2C	D02/D03 CU2D	E01 CU2E	P01 CU2P	+113 PTS	+123 PTS	+144 PTS	+157 PTS	+177 PTS	
B01/B03 CU2B	C01/C05 CU2C	D02/D03 CU2D	E01 CU2E	P01 CU2P									
+113 PTS	+123 PTS	+144 PTS	+157 PTS	+177 PTS									
	Padded seat, upholstery on request Assise rembourrée, revêtement sur demande Gepolsterter Sitz; Überzug auf Anfrage	<table border="1"> <tr> <td>D04/D06 CU2D</td> <td>E02/E03 CU2E</td> <td>I01/102 CU2I</td> <td>M02/M03 CU2M</td> </tr> <tr> <td>+144 PTS</td> <td>+157 PTS</td> <td>+204 PTS</td> <td>+231 PTS</td> </tr> </table>	D04/D06 CU2D	E02/E03 CU2E	I01/102 CU2I	M02/M03 CU2M	+144 PTS	+157 PTS	+204 PTS	+231 PTS			
D04/D06 CU2D	E02/E03 CU2E	I01/102 CU2I	M02/M03 CU2M										
+144 PTS	+157 PTS	+204 PTS	+231 PTS										
	65mmØ twin wheel brake unloaded hard black castors Roulettes standard Ø65mm- autofreinées Standard-Rollen Ø65mm - selbstbremsend	RG06	=										
	65mmØ twin wheel brake unloaded soft black castors Roulettes sol dur Ø65mm - autofreinées Gummirollen Ø65mm - selbstbremsend	RG02	+25 PTS										







Cove polypropylene chair, 5-star swivel frame on castors

Chaise en polypropylène Cove, base pivotante 5 branches sur roulettes

Cove Stuhl Polypropylen, 5 Sternfuß auf Rollen

COVE

FULL POLYPROPYLENE SHELL
COQUE EN POLYPROPYLENE
SCHALE AUS POLYPROPYLEN

ACCESSORIES / ACCESSOIRES / ZUBEHÖR			
	60mmØ twin wheel unbraked white soft castors Roulettes sol dur blanches Ø60mm - libres Weiße Gummirollen Ø60mm	RG07	+33 PTS
	60mmØ twin wheel unbraked silver soft castors Roulettes sol dur alu Ø60mm - libres Aluminium-Gummirollen Ø60mm	RG08	+33 PTS
	65mmØ twin wheel brake unloaded ring-shaped white soft castors Roulettes "ring" sol dur blanches Ø65mm - autofreinées Weiß gummierte "Ring"-Rollen Ø65mm - selbstbremsend	RG09	+51 PTS
	65mmØ twin wheel brake unloaded ring-shaped soft silver castors Roulettes "ring" sol dur alu Ø65mm - autofreinées Gummierte Aluminium "Ring"-Rollen Ø65mm - selbstbremsend	RG10	+51 PTS
	65mmØ twin wheel brake unloaded ring-shaped soft black castors Roulettes "ring" sol dur noires Ø65mm - autofreinées Schwarz gummierte "Ring"-Rollen Ø65mm - selbstbremsend	RG12	+51 PTS
	65mmØ twin wheel brake unloaded ring-shaped soft black/chrome castors - chrome metal hood Roulettes "ring" sol dur chromées/noires Ø65mm - autofreinées Verchromte/schwarze Gummirollen Ø65mm - selbstbremsend	RG11	+56 PTS
ON REQUEST ONLY / SUR REQUETE / AUF ANFRAGE			
	Fire retardant shell, 300-unit minimum order in one color Version non-feu, à partir de 300 pièces Feuerfeste Ausführung, mindestens 300 Schalen pro Farbe	IGNI	+28 PTS

COVE

FULL POLYPROPYLENE SHELL
COQUE EN POLYPROPYLÈNE
SCHALE AUS POLYPROPYLEN

Cove polypropylene 750mm high stool, 4 metal legs Tabouret Cove polypropylène, 4 pieds métal, H 75cm Cove, Barhocker 4-Fuß Gestell Metall, Polypropylen, Sitzhöhe 75 Cm

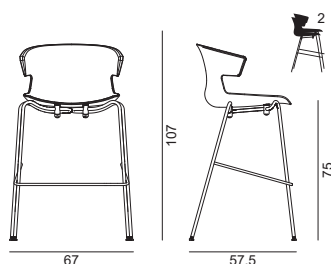

1 box
2 u. x box
0,340 M³

KG 15,00
18,00

Cod. OCOVES01

8mm polypropylene shell; frame made from Ø16mm highly resilient chromed steel tube; polyethylene glides; spacers on the underside of the seat covered with protective rubber for stacking.

Coque en polypropylène ép. 8mm; cadre en tube d'acier à haute résistance Ø16mm chromé; patins en polyéthylène; entretoises de protection en caoutchouc pour empilabilité.

Schale aus Polypropylen, Stärke 8mm; Rahmen aus hochfestem Stahlrohr Ø16mm verchromt; Füße aus Polyethylen; Abstandhalter mit Schutzgummi für Stapelbarkeit.

BA RAL 9003	BG NCS S 4010 Y30R	GR PANTONE 421	GO RAL 7022	OC NCS S 2060 Y20R	AB NCS S 4040 Y50R	VD NCS S 6020 G70Y	BT NCS S 5030 R80B
TM RAL 8014							

Depending on the surface the color may vary slightly from the reference (RAL / NCS) provided.
En fonction de la surface, la couleur peut varier légèrement par rapport à la référence (RAL / NCS) fournie.
Je nach Oberfläche kann die Farbe in Bezug auf die RAL/NCS Referenz abweichen.

CATAS EN 16139 Level 1

FRAME / CADRE / GESTELL



Chrome frame
Cadre chromé
Verchromtes Gestell

FSC13

235 PTS

ACCESSORIES / ACCESSOIRES / ZUBEHÖR



B01/B03 fabric/faux leather upholstered small soft pad in the shown colors
Coussin revêtu en tissu/textile enduit B01/B03 (dans les revêtements indiqués)
Gepolstertes Kissen mit Stoff/Kunstleder Kat. B01/B03 bezogen (in den angegebenen Farben)

CU1B

+46 PTS

B01: 009 / 010 / 012 / 013 / 018 / 023 / 027 / 028 / 222
B03: 138 / 175 / 176 / 180 / 183 / 184 / 185 / 186

B01 & B03 finishes which do not show are available on request, 12 unit minimum order: further +17 pts upcharge / Les revêtements B01 et B03 non indiqués, sont disponibles sur requête, min. 12 pièces: +17 pts / Die Farben aus der Kategorie B01 bzw. B03, die hier nicht angegeben sind, sind auf Anfrage erhältlich, ab 12 Stück: + 17 Pkte



Upholstered large soft pad
Assise rembourrée
Gepolsterter Sitz

B01/B03
CU2B
+113 PTS

C01/C05
CU2C
+123 PTS

D02/D03
CU2D
+144 PTS

E01
CU2E
+157 PTS

P01
CU2P
+177 PTS



Padded seat, upholstery on request
Assise rembourrée, revêtement sur demande
Gepolsterter Sitz; Überzug auf Anfrage

D04/D06
CU2D
+144 PTS

E02/E03
CU2E
+157 PTS

I01/I02
CU2I
+204 PTS

M02/M03
CU2M
+231 PTS



Set of silent anti-scratch felt pads and glides
Kit de patins de feutres et patins anti-rayures et anti-bruit
Kit kratzfesten und geräuschkämpfenden Filzgleiter.

ACC12

+17 PTS



Articulating adjustable feet complete with felt pads
Patins feutrés dénoués
Gelenkfüße mit Filzgleiter

PD001

+20 PTS

ON REQUEST ONLY / SUR REQUETE / AUF ANFRAGE



Fire retardant shell, 300-unit minimum order in one color
Version non-feu, à partir de 300 pièces
Feuerfeste Ausführung, mindestens 300 Schalen pro Farbe

IGNI

+28 PTS

Cove polypropylene 750mm high stool, 4 metal legs
Tabouret Cove polypropylène, 4 pieds métal, H 75cm
Cove, Barhocker 4-Fuß Gestell Metall, Polypropylen, Sitzhöhe 75 Cm

COVE

FULL POLYPROPYLENE SHELL
 COQUE EN POLYPROPYLÈNE
 SCHALE AUS POLYPROPYLEN

ON REQUEST ONLY / SUR REQUÊTE / AUF ANFRAGE		
	Gold powder coated frame Structure vernie or Gestell Gold lackiert	OR +131 PTS
	Bronze powder coated frame Structure vernie bronze Gestell Bronze lackiert	BR +131 PTS
	Corten powder coated frame Structure vernie corten Gestell Corten lackiert	CO +131 PTS
	Powder coated frame in a special finish, 2-unit minimum order Cadre en coloris spéciaux, à partir de 2 pièces Gestell: Sonderlackierung nach Kundenwunsch, ab 2 Stück Price on request for special varnish finishes / Pour vernis spécifiques, devis sur requête / Sonderlackfarben auf Anfrage	VERN +83 PTS

COVE

FULL POLYPROPYLENE SHELL
COQUE EN POLYPROPYLÈNE
SCHALE AUS POLYPROPYLEN

Cove polypropylene 650mm high stool, 4 metal legs Tabouret Cove polypropylène, 4 pieds métal, H 65cm Cove, Barhocker 4-Fuß Gestell Metall, Polypropylen, Sitzhöhe 65 Cm

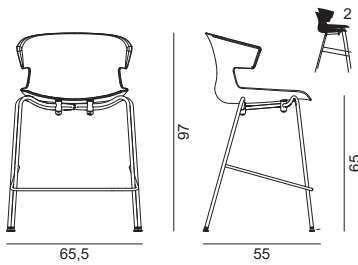

1 box
2 u. x box
0,340 M³

KG 14,00
17,00

Cod. OCOVES02

8mm polypropylene shell; frame made from Ø16mm highly resilient chromed steel tube; polyethylene glides; spacers on the underside of the seat covered with protective rubber for stacking.

Coque en polypropylène ép. 8mm; cadre en tube d'acier à haute résistance Ø16mm chromé; patins en polyéthylène; entretoises de protection en caoutchouc pour empilabilité.

Schale aus Polypropylen, Stärke 8mm; Rahmen aus hochfestem Stahlrohr Ø16mm verchromt; Füße aus Polyethylen; Abstandhalter mit Schutzgummi für Stapelbarkeit.

BA RAL 9003	BG NCS S 4010 Y30R	GR PANTONE 421	GO RAL 7022	OC NCS S 2060 Y20R	AB NCS S 4040 Y50R	VD NCS S 6020 G70Y	BT NCS S 5030 R80B
TM RAL 8014							

Depending on the surface the color may vary slightly from the reference (RAL / NCS) provided.
En fonction de la surface, la couleur peut varier légèrement par rapport à la référence (RAL / NCS) fournie.
Je nach Oberfläche kann die Farbe in Bezug auf die RAL/NCS Referenz abweichen.

CATAS EN 16139 Level 1

FRAME / CADRE / GESTELL



Chrome frame
Cadre chromé
Verchromtes Gestell

FSC14

235 PTS

ACCESSORIES / ACCESSOIRES / ZUBEHÖR



B01/B03 fabric/faux leather upholstered small soft pad in the shown colors
Coussin revêtu en tissu/textile enduit B01/B03 (dans les revêtements indiqués)
Gepolstertes Kissen mit Stoff/Kunstleder Kat. B01/B03 bezogen (in den angegebenen Farben)

CU1B

+46 PTS

B01: 009 / 010 / 012 / 013 / 018 / 023 / 027 / 028 / 222
B03: 138 / 175 / 176 / 180 / 183 / 184 / 185 / 186

B01 & B03 finishes which do not show are available on request, 12 unit minimum order: further +17 pts upcharge / Les revêtements B01 et B03 non indiqués, sont disponibles sur requête, min. 12 pièces: +17 pts / Die Farben aus der Kategorie B01 bzw. B03, die hier nicht angegeben sind, sind auf Anfrage erhältlich, ab 12 Stück: + 17 Pkte



Upholstered large soft pad
Assise rembourrée
Gepolsterter Sitz

B01/B03
CU2B

C01/C05
CU2C

D02/D03
CU2D

E01
CU2E

P01
CU2P

+113 PTS

+123 PTS

+144 PTS

+157 PTS

+177 PTS



Padded seat, upholstery on request
Assise rembourrée, revêtement sur demande
Gepolsterter Sitz; Überzug auf Anfrage

D04/D06
CU2D

E02/E03
CU2E

I01/102
CU2I

M02/M03
CU2M

+144 PTS

+157 PTS

+204 PTS

+231 PTS



Set of silent anti-scratch felt pads and glides
Kit de patins de feutres et patins anti-rayures et anti-bruit
Kit kratzfesten und geräuschkämpfenden Filzgleiter.

ACC12

+17 PTS



Articulating adjustable feet complete with felt pads
Patins feutrés dénoués
Gelenkfüße mit Filzgleiter

PD001

+20 PTS

ON REQUEST ONLY / SUR REQUETE / AUF ANFRAGE



Fire retardant shell, 300-unit minimum order in one color
Version non-feu, à partir de 300 pièces
Feuerfeste Ausführung, mindestens 300 Schalen pro Farbe

IGNI

+28 PTS

Cove polypropylene 650mm high stool, 4 metal legs
 Tabouret Cove polypropylène, 4 pieds métal, H 65cm
 Cove, Barhocker 4-Fuß Gestell Metall, Polypropylen, Sitzhöhe 65 Cm

COVE

FULL POLYPROPYLENE SHELL
 COQUE EN POLYPROPYLENE
 SCHALE AUS POLYPROPYLEN

ON REQUEST ONLY / SUR REQUETE / AUF ANFRAGE		
	Gold powder coated frame Structure vernie or Gestell Gold lackiert	OR +131 PTS
	Bronze powder coated frame Structure vernie bronze Gestell Bronze lackiert	BR +131 PTS
	Corten powder coated frame Structure vernie corten Gestell Corten lackiert	CO +131 PTS
	Powder coated frame in a special finish, 2-unit minimum order Cadre en coloris spéciaux, à partir de 2 pièces Gestell: Sonderlackierung nach Kundenwunsch, ab 2 Stück Price on request for special varnish finishes / Pour vernis spécifiques, devis sur requête / Sonderlackfarben auf Anfrage	VERN +83 PTS

COVE

FULL POLYPROPYLENE SHELL
COQUE EN POLYPROPYLÈNE
SCHALE AUS POLYPROPYLEN

Cove polypropylene stool, height adjustable swivel base Tabouret Cove polypropylène, base pivotante et vérin Cove, Barhocker, Dreh- Und Höhenverstellbar

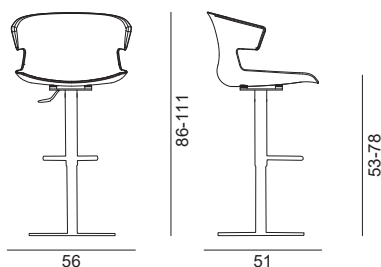

1 box
1 u. x box
0,350 M³

21,00
24,00

Cod. OCOVES03

8mm polypropylene shell; steel plate; gas lift; weighted base covered with chrome steel sheet metal with height adjustable footrest.

Coque en polypropylène ép. 8 mm; plaque en acier; vérin à gaz lift; piètement avec vérin recouvert en tôle d'acier chromé avec appuie-pieds à élévation.

Sitzschale aus Polypropylen, Stärke 8 mm; Stahlplatte; Gasfeder; Sockel mit Ballast, abgedeckt aus verchromtem Stahlblech mit Fußstütze in der Höhe.

BA RAL 9003	BG NCS S 4010 Y30R	GR PANTONE 421	GO RAL 7022	OC NCS S 2060 Y20R	AB NCS S 4040 Y50R	VD NCS S 6020 G70Y	BT NCS S 5030 R80B
TM RAL 8014							

Depending on the surface the color may vary slightly from the reference (RAL / NCS) provided.
En fonction de la surface, la couleur peut varier légèrement par rapport à la référence (RAL / NCS) fournie.
Je nach Oberfläche kann die Farbe in Bezug auf die RAL/NCS Referenz abweichen.

BASE / BASE / GESTELL



Chrome weighted flat base with height adjustable footrest
Piètement chromé avec appuie-pieds et lift
Gestell verchromt, inkl. Fußstütze höhenverstellbar

BAC03

523 PTS

ACCESSORIES / ACCESSOIRES / ZUBEHÖR



B01/B03 fabric/faux leather upholstered small soft pad in the shown colors
Coussin revêtu en tissu/textile enduit B01/B03 (dans les revêtements indiqués)
Gepolstertes Kissen mit Stoff/Kunstleder Kat. B01/B03 bezogen (in den angegebenen Farben)

CU1B

+46 PTS

B01: 009 / 010 / 012 / 013 / 018 / 023 / 027 / 028 / 222
B03: 138 / 175 / 176 / 180 / 183 / 184 / 185 / 186

B01 & B03 finishes which do not show are available on request, 12 unit minimum order: further +17 pts upcharge / Les revêtements B01 et B03 non indiqués, sont disponibles sur requête, min. 12 pièces: +17 pts / Die Farben aus der Kategorie B01 bzw. B03, die hier nicht angegeben sind, sind auf Anfrage erhältlich, ab 12 Stück: +17 Pkte



Upholstered large soft pad
Assise rembourrée
Gepolsterter Sitz

B01/B03
CU2B
+113 PTS

C01/C05
CU2C
+123 PTS

D02/D03
CU2D
+144 PTS

E01
CU2E
+157 PTS

P01
CU2P
+177 PTS



Padded seat, upholstery on request
Assise rembourrée, revêtement sur demande
Gepolsterter Sitz; Überzug auf Anfrage

D04/D06
CU2D
+144 PTS

E02/E03
CU2E
+157 PTS

I01/102
CU2I
+204 PTS

M02/M03
CU2M
+231 PTS

ON REQUEST ONLY / SUR REQUETE / AUF ANFRAGE



Fire retardant shell, 300-unit minimum order in one color
Version non-feu, à partir de 300 pièces
Feuerfeste Ausführung, mindestens 300 Schalen pro Farbe

IGNI

+28 PTS

Cove polypropylene stool, 5-star swivel base

Tabouret Cove polypropylène, base pivotante 5 branches

Cove, Barhocker Dreh- Und Höhenverstellbar 5-Sterne Fußkreuz

COVE

FULL POLYPROPYLENE SHELL
COQUE EN POLYPROPYLÈNE
SCHALE AUS POLYPROPYLEN

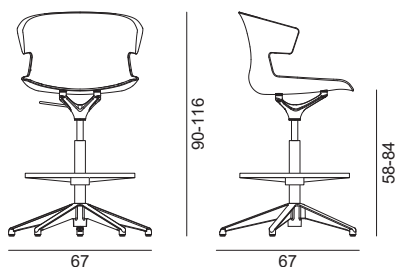

Cod. OCOVES04

8mm polypropylene shell; gaslift; aluminium plate; height adjustable footrest.

Coque en polypropylène ép. 8mm; liftgas; plaque en alu; appuie-pieds réglable en hauteur.

Sitzschale aus Polypropylen, Stärke 8 mm; Gasfeder; Aluminiumplatte; höhenverstellbare Fußstütze.

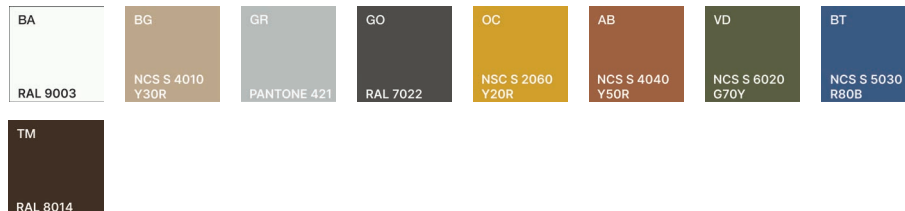

1 box
1 u. x box
0,190 M³

8,00
10,00
KG

Depending on the surface the color may vary slightly from the reference (RAL / NCS) provided.
En fonction de la surface, la couleur peut varier légèrement par rapport à la référence (RAL / NCS) fournie.
Je nach Oberfläche kann die Farbe in Bezug auf die RAL/NCS Referenz abweichen.

BASE / BASE / GESTELL

	Powder coated aluminium 5-star base, silver finish Piètement 5 branches en alu avec plaque en teinte 5-Sternfußkreuz aus Aluminium, Ausführung Silber pulverbeschichtet	BAA10	427 PTS
	Powder coated aluminium 5-star base, white finish Piètement 5 branches en alu verni blanc avec plaque en teinte 5-Sternfußkreuz aus Aluminium, Ausführung Weiß pulverbeschichtet	BAA11	427 PTS

ACCESSORIES / ACCESSOIRES / ZUBEHÖR

	B01/B03 fabric/faux leather upholstered small soft pad in the shown colors Coussin revêtu en tissu/textile enduit B01/B03 (dans les revêtements indiqués) Gepolstertes Kissen mit Stoff/Kunstleder Kat. B01/B03 bezogen (in den angegebenen Farben)	CU1B	+46 PTS										
<p>B01: 009 / 010 / 012 / 013 / 018 / 023 / 027 / 028 / 222 B03: 138 / 175 / 176 / 180 / 183 / 184 / 185 / 186</p> <p><small>B01 & B03 finishes which do not show are available on request, 12 unit minimum order: furter +17 pts upcharge / Les revêtements B01 et B03 non indiqués, sont disponibles sur requête, min. 12 pièces: +17 pts / Die Farben aus der Kategorie B01 bzw. B03, die hier nicht angegeben sind, sind auf Anfrage erhältlich, ab 12 Stück: + 17 Pkte</small></p>													
	Upholstered large soft pad Assise rembourrée Gepolsterter Sitz	<table border="1"> <tr> <td>B01/B03 CU2B</td> <td>C01/C05 CU2C</td> <td>D02/D03 CU2D</td> <td>E01 CU2E</td> <td>P01 CU2P</td> </tr> <tr> <td>+113 PTS</td> <td>+123 PTS</td> <td>+144 PTS</td> <td>+157 PTS</td> <td>+177 PTS</td> </tr> </table>	B01/B03 CU2B	C01/C05 CU2C	D02/D03 CU2D	E01 CU2E	P01 CU2P	+113 PTS	+123 PTS	+144 PTS	+157 PTS	+177 PTS	
B01/B03 CU2B	C01/C05 CU2C	D02/D03 CU2D	E01 CU2E	P01 CU2P									
+113 PTS	+123 PTS	+144 PTS	+157 PTS	+177 PTS									
	Padded seat, upholstery on request Assise rembourrée, revêtement sur demande Gepolsterter Sitz; Überzug auf Anfrage	<table border="1"> <tr> <td>D04/D06 CU2D</td> <td>E02/E03 CU2E</td> <td>I01/102 CU2I</td> <td>M02/M03 CU2M</td> </tr> <tr> <td>+144 PTS</td> <td>+157 PTS</td> <td>+204 PTS</td> <td>+231 PTS</td> </tr> </table>	D04/D06 CU2D	E02/E03 CU2E	I01/102 CU2I	M02/M03 CU2M	+144 PTS	+157 PTS	+204 PTS	+231 PTS			
D04/D06 CU2D	E02/E03 CU2E	I01/102 CU2I	M02/M03 CU2M										
+144 PTS	+157 PTS	+204 PTS	+231 PTS										

ON REQUEST ONLY / SUR REQUETE / AUF ANFRAGE

	Fire retardant shell, 300-unit minimum order in one color Version non-feu, à partir de 300 pièces Feuerfeste Ausführung, mindestens 300 Schalen pro Farbe	IGNI	+28 PTS
--	--	-------------	---------

COVE

FULL POLYPROPYLENE SHELL
COQUE EN POLYPROPYLENE
SCHALE AUS POLYPROPYLEN

Cove 2-person polypropylene beam seat Poutre Cove polypropylène, 2 places Cove, 2er Bank

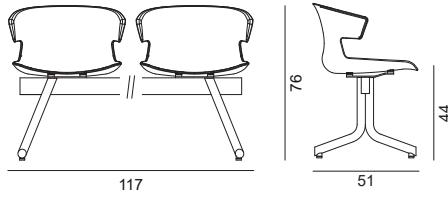

1 box
3 u. x box
0,170 M³

KG 16,00
19,00

Cod. OCOVE201

8mm polypropylene shell; 80×40×2mm beam made from powder coated steel tube; 400×2mm powder coated steel legs; polyethylene adjustable levelling feet.

Coque interne en polypropylène ép. 8mm; poutre en acier 80×40×2 verni à poudre époxy; pieds en tube d'acier 40×2 vernis à poudre époxy; patins réglables en polyéthylène.

Körper aus Polypropylen, Stärke 8 mm; Stahlträger 80×40×2 epoxidpulverbeschichtet; Beine aus Stahlrohr 40×2 epoxidpulverbeschichtet; verstellbare Füße aus Polyethylen.

BA RAL 9003	BG NCS S 4010 Y30R	GR PANTONE 421	GO RAL 7022	OC NCS S 2060 Y20R	AB NCS S 4040 Y50R	VD NCS S 6020 G70Y	BT NCS S 5030 R80B
TM RAL 8014							

Depending on the surface the color may vary slightly from the reference (RAL / NCS) provided.
En fonction de la surface, la couleur peut varier légèrement par rapport à la référence (RAL / NCS) fournie.
Je nach Oberfläche kann die Farbe in Bezug auf die RAL/NCS Referenz abweichen.

BASE / BASE / GESTELL

	Powder coated frame and beam in silver Piètement verni alu; poutre en teinte <i>Untergestell Metall Alu pulverbeschichtet. Traverse in gleicher Farbe</i>	STR06VA	617 PTS
--	--	----------------	---------

ACCESSORIES / ACCESSOIRES / ZUBEHÖR

	B01/B03 fabric/faux leather upholstered small soft pad in the shown colors Coussin revêtu en tissu/textile enduit B01/B03 (dans les revêtements indiqués) <i>Gepolstertes Kissen mit Stoff/Kunstleder Kat. B01/B03 bezogen (in den angegebenen Farben)</i>	CU1B	+46 PTS			
B01: 009 / 010 / 012 / 013 / 018 / 023 / 027 / 028 / 222 B03: 138 / 175 / 176 / 180 / 183 / 184 / 185 / 186	B01 & B03 finishes which do not show are available on request, 12 unit minimum order: further +17 pts upcharge / Les revêtements B01 et B03 non indiqués, sont disponibles sur requête, min. 12 pièces: +17 pts / Die Farben aus der Kategorie B01 bzw. B03, die hier nicht angegeben sind, sind auf Anfrage erhältlich, ab 12 Stück: + 17 Pkte					
	Upholstered large soft pad Assise rembourrée <i>Gepolsterter Sitz</i>	B01/B03 CU2B	C01/C05 CU2C	D02/D03 CU2D	E01 CU2E	P01 CU2P
		+113 PTS	+123 PTS	+144 PTS	+157 PTS	+177 PTS
	Padded seat, upholstery on request Assise rembourrée, revêtement sur demande <i>Gepolsterter Sitz; Überzug auf Anfrage</i>		D04/D06 CU2D	E02/E03 CU2E	I01/102 CU2I	M02/M03 CU2M
			+144 PTS	+157 PTS	+204 PTS	+231 PTS
	White MFC table Table blanche en mélamine <i>Couchtisch aus weißem Melamin</i> Takes the place of one seat / Chaque tablette remplace une assise / Jede Tischplatte ersetzt einen Sitzplatz	TAV07	-22 PTS			

ON REQUEST ONLY / SUR REQUETE / AUF ANFRAGE

	Powder coated frame in a special finish, 2-unit minimum order Cadre en coloris spéciaux, à partir de 2 pièces <i>Gestell: Sonderlackierung nach Kundenwunsch, ab 2 Stück</i> Price on request for special varnish finishes / Pour vernis spécifiques, devis sur requête / Sonderlackfarben auf Anfrage	VERN	+165 PTS
	Fire retardant shell, 300-unit minimum order in one color Version non-feu, à partir de 300 pièces <i>Feuerfeste Ausführung, mindestens 300 Schalen pro Farbe</i>	IGNI	+52 PTS

Cove 3-person polypropylene beam seat
Poutre Cove polypropylène, 3 places
Cove, 3erBank

COVE

FULL POLYPROPYLENE SHELL
 COQUE EN POLYPROPYLÈNE
 SCHALE AUS POLYPROPYLEN

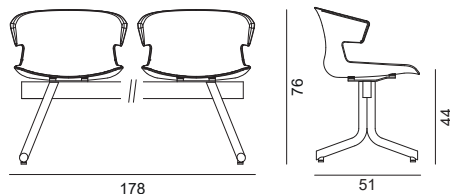

Cod. OCOVE301

8mm polypropylene shell; 80×40×2mm beam made from powder coated steel tube; 400×2mm powder coated steel legs; polyethylene adjustable levelling feet.

Coque interne en polypropylène ép. 8mm; poutre en acier 80×40×2 verni à poudre époxy; pieds en tube d'acier 40×2 vernis à poudre époxy; patins réglables en polyéthylène.

Körper aus Polypropylen, Stärke 8 mm; Stahlträger 80×40×2 epoxidpulverbeschichtet; Beine aus Stahlrohr 40×2 epoxidpulverbeschichtet; verstellbare FüÙe aus Polyethylen.

1 box
 3 u. x box
 0,180 M³

KG
 26,00
 31,00

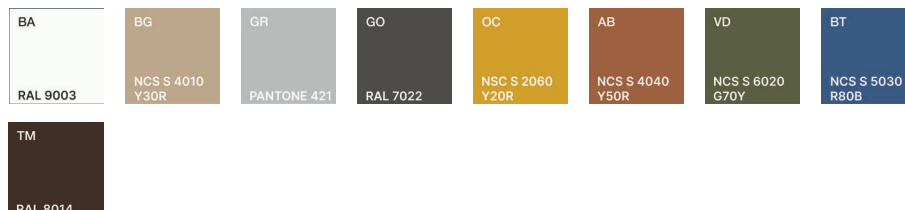

Depending on the surface the color may vary slightly from the reference (RAL / NCS) provided.
 En fonction de la surface, la couleur peut varier légèrement par rapport à la référence (RAL / NCS) fournie.
 Je nach Oberfläche kann die Farbe in Bezug auf die RAL/NCS Referenz abweichen.

BASE / BASE / GESTELL

	Powder coated frame and beam in silver Piètement verni alu; poutre en teinte Untergestell Metall Alu pulverbeschichtet. Traverse in gleicher Farbe	STR06VA	761 PTS
--	---	----------------	---------

ACCESSORIES / ACCESSOIRES / ZUBEHÖR

	B01/B03 fabric/faux leather upholstered small soft pad in the shown colors Coussin revêtu en tissu/textile enduit B01/B03 (dans les revêtements indiqués) Gepolstertes Kissen mit Stoff/Kunstleder Kat. B01/B03 bezogen (in den angegebenen Farben)	CU1B	+46 PTS										
B01: 009 / 010 / 012 / 013 / 018 / 023 / 027 / 028 / 222 B03: 138 / 175 / 176 / 180 / 183 / 184 / 185 / 186		B01 & B03 finishes which do not show are available on request, 12 unit minimum order: furter +17 pts upcharge / Les revêtements B01 et B03 non indiqués, sont disponibles sur requête, min. 12 pièces: +17 pts / Die Farben aus der Kategorie B01 bzw. B03, die hier nicht angegeben sind, sind auf Anfrage erhältlich, ab 12 Stück: + 17 Pkte											
	Upholstered large soft pad Assise rembourrée Gepolsterter Sitz	<table border="1"> <tr> <td>B01/B03 CU2B</td> <td>C01/C05 CU2C</td> <td>D02/D03 CU2D</td> <td>E01 CU2E</td> <td>P01 CU2P</td> </tr> <tr> <td>+113 PTS</td> <td>+123 PTS</td> <td>+144 PTS</td> <td>+157 PTS</td> <td>+177 PTS</td> </tr> </table>	B01/B03 CU2B	C01/C05 CU2C	D02/D03 CU2D	E01 CU2E	P01 CU2P	+113 PTS	+123 PTS	+144 PTS	+157 PTS	+177 PTS	
B01/B03 CU2B	C01/C05 CU2C	D02/D03 CU2D	E01 CU2E	P01 CU2P									
+113 PTS	+123 PTS	+144 PTS	+157 PTS	+177 PTS									
	Padded seat, upholstery on request Assise rembourrée, revêtement sur demande Gepolsterter Sitz; Überzug auf Anfrage	<table border="1"> <tr> <td>D04/D06 CU2D</td> <td>E02/E03 CU2E</td> <td>I01/I02 CU2I</td> <td>M02/M03 CU2M</td> </tr> <tr> <td>+144 PTS</td> <td>+157 PTS</td> <td>+204 PTS</td> <td>+231 PTS</td> </tr> </table>	D04/D06 CU2D	E02/E03 CU2E	I01/I02 CU2I	M02/M03 CU2M	+144 PTS	+157 PTS	+204 PTS	+231 PTS			
D04/D06 CU2D	E02/E03 CU2E	I01/I02 CU2I	M02/M03 CU2M										
+144 PTS	+157 PTS	+204 PTS	+231 PTS										
	White MFC table Table blanche en mélamine Couchtisch aus weißem Melamin Takes the place of one seat / Chaque tablette remplace une assise / Jede Tischplatte ersetzt einen Sitzplatz	TAV07	-22 PTS										

ON REQUEST ONLY / SUR REQUETE / AUF ANFRAGE

	Powder coated frame in a special finish, 2-unit minimum order Cadre en coloris spéciaux, à partir de 2 pièces Gestell: Sonderlackierung nach Kundenwunsch, ab 2 Stück Price on request for special varnish finishes / Pour vernis spécifiques, devis sur requête / Sonderlackfarben auf Anfrage	VERN	+165 PTS
	Fire retardant shell, 300-unit minimum order in one color Version non-feu, à partir de 300 pièces Feuerfeste Ausführung, mindestens 300 Schalen pro Farbe	IGNI	+81 PTS

COVE

FULL POLYPROPYLENE SHELL
COQUE EN POLYPROPYLÈNE
SCHALE AUS POLYPROPYLEN

Cove 4-person polypropylene beam seat Poutre Cove polypropylène, 4 places Cove, 4er Bank

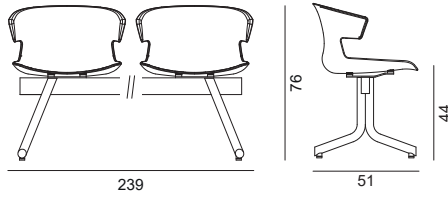

1 box
3 u. x box
0,320 M³

33,00
38,00

Cod. OCOVE401

8mm polypropylene shell; 80×40×2mm beam made from powder coated steel tube; 400×2mm powder coated steel legs; polyethylene adjustable levelling feet.

Coque interne en polypropylène ép. 8mm; poutre en acier 80×40×2 verni à poudre époxy; pieds en tube d'acier 40×2 vernis à poudre époxy; patins réglables en polyéthylène.

Körper aus Polypropylen, Stärke 8 mm; Stahlträger 80×40×2 epoxidpulverbeschichtet; Beine aus Stahlrohr 40×2 epoxidpulverbeschichtet; verstellbare Füße aus Polyethylen.

BA RAL 9003	BG NCS S 4010 Y30R	GR PANTONE 421	GO RAL 7022	OC NCS S 2060 Y20R	AB NCS S 4040 Y50R	VD NCS S 6020 G70Y	BT NCS S 5030 R80B
TM RAL 8014							

Depending on the surface the color may vary slightly from the reference (RAL / NCS) provided.
En fonction de la surface, la couleur peut varier légèrement par rapport à la référence (RAL / NCS) fournie.
Je nach Oberfläche kann die Farbe in Bezug auf die RAL/NCS Referenz abweichen.

BASE / BASE / GESTELL

	Powder coated frame and beam in silver Piètement verni alu; poutre en teinte <i>Untergestell Metall Alu pulverbeschichtet. Traverse in gleicher Farbe</i>	STR06VA	916 PTS
--	--	----------------	---------

ACCESSORIES / ACCESSOIRES / ZUBEHÖR

	B01/B03 fabric/faux leather upholstered small soft pad in the shown colors Coussin revêtu en tissu/textile enduit B01/B03 (dans les revêtements indiqués) <i>Gepolstertes Kissen mit Stoff/Kunstleder Kat. B01/B03 bezogen (in den angegebenen Farben)</i>	CU1B	+46 PTS			
B01: 009 / 010 / 012 / 013 / 018 / 023 / 027 / 028 / 222 B03: 138 / 175 / 176 / 180 / 183 / 184 / 185 / 186	B01 & B03 finishes which do not show are available on request, 12 unit minimum order: furter +17 pts upcharge / Les revêtements B01 et B03 non indiqués, sont disponibles sur requête, min. 12 pièces: +17 pts / Die Farben aus der Kategorie B01 bzw. B03, die hier nicht angegeben sind, sind auf Anfrage erhältlich, ab 12 Stück: + 17 Pkte					
	Upholstered large soft pad Assise rembourrée <i>Gepolsterter Sitz</i>	B01/B03 CU2B	C01/C05 CU2C	D02/D03 CU2D	E01 CU2E	P01 CU2P
		+113 PTS	+123 PTS	+144 PTS	+157 PTS	+177 PTS
	Padded seat, upholstery on request Assise rembourrée, revêtement sur demande <i>Gepolsterter Sitz; Überzug auf Anfrage</i>	D04/D06 CU2D	E02/E03 CU2E	I01/102 CU2I	M02/M03 CU2M	
		+144 PTS	+157 PTS	+204 PTS	+231 PTS	
	White MFC table Table blanche en mélamine <i>Couchtisch aus weißem Melamin</i> Takes the place of one seat / Chaque tablette remplace une assise / Jede Tischplatte ersetzt einen Sitzplatz	TAV07	-22 PTS			

ON REQUEST ONLY / SUR REQUETE / AUF ANFRAGE

	Powder coated frame in a special finish, 2-unit minimum order Cadre en coloris spéciaux, à partir de 2 pièces <i>Gestell: Sonderlackierung nach Kundenwunsch, ab 2 Stück</i> Price on request for special varnish finishes / Pour vernis spécifiques, devis sur requête / Sonderlackfarben auf Anfrage	VERN	+165 PTS
	Fire retardant shell, 300-unit minimum order in one color Version non-feu, à partir de 300 pièces <i>Feuerfeste Ausführung, mindestens 300 Schalen pro Farbe</i>	IGNI	+107 PTS

Cove fully upholstered chair, 4 metal legs
 Chaise tapissée Cove, 4 pieds métal
 Cove Stuhl gepolstert, 4-Fuß Gestell Metall

COVE

FULLY UPHOLSTERED SHELL
 COQUE TAPISSÉE
 GEPOLSTERTE SCHALE

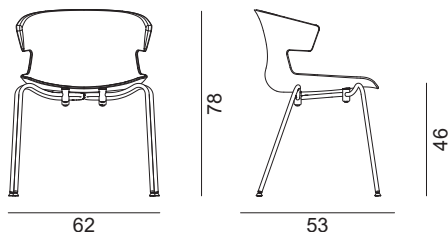

Cod. OCOVEV21

8mm polypropylene shell; injection moulded polyurethane foam; frame made from Ø16mm highly resilient steel tube; polyethylene glides.

Coque interne en polypropylène ép.8 mm; rembourrage en polyuréthane expansée à mousse; cadre en tube d'acier à haute résistance Ø16mm; patins en polyéthylène.

Innenkörper aus 8 mm starkem Polypropylen; Polsterung aus geschäumtem Polyurethan; Gestell aus 16 mm starkem Stahlrohr; Füße aus Polyethylen.

CATAS UNI EN 16139 Level 1, UNI EN 1022, UNI EN 1728 1IM fire retardant B01 fabric upholstered shell

1 box
 1 u. x box
 0,170 M³

5,50
 7,50

UPHOLSTERY / REVETEMENT / BEZUG

B01/B03	C01/C05	D02/D03	E01	P01
476 PTS	520 PTS	547 PTS	594 PTS	608 PTS

UPHOLSTERY ON REQUEST / REVETEMENT SUR REQUETE / ÜBERZUG AUF ANFRAGE

D04	E02/E03	I01/I02	M02/M03
547 PTS	594 PTS	748 PTS	828 PTS

FRAME / CADRE / GESTELL

	Chrome frame Cadre chromé Verchromtes Gestell	FSC11	=
	Powder coated frame in silver Cadre verni alu Gestell Aluminium lackiert	FSG11	=
	Powder coated frame in white Cadre verni blanc Gestell Weiß lackiert	FSB11	=
	Powder coated frame in anthracite Cadre verni gris ombre Gestell Dunkelgrau lackiert	FST11	=

ACCESSORIES / ACCESSOIRES / ZUBEHÖR

	Articulating adjustable feet complete with felt pads Patins feutrés dénoués Gelenkfüße mit Filzgleiter	PD001	+20 PTS
	Set of silent anti-scratch felt pads and glides Kit de patins de feutres et patins anti-rayures et anti-bruit Kit kratzfesten und geräuschkämpfenden Filzgleiter.	ACC12	+17 PTS

ON REQUEST ONLY / SUR REQUETE / AUF ANFRAGE



	Gold powder coated frame Structure vernie or Gestell Gold lackiert	OR	+131 PTS
--	---	----	----------

COVE

FULLY UPHOLSTERED SHELL
COQUE TAPISSÉE
GEPOLSTERTE SCHALE

Cove fully upholstered chair, 4 metal legs
Chaise tapissée Cove, 4 pieds métal
Cove Stuhl gepolstert, 4-Fuß Gestell Metall

ON REQUEST ONLY / SUR REQUÊTE / AUF ANFRAGE

	Bronze powder coated frame Structure vernie bronze Gestell Bronze lackiert	BR	+131 PTS
	Corten powder coated frame Structure vernie corten Gestell Corten lackiert	CO	+131 PTS
	Powder coated frame in a special finish, 6-unit minimum order Cadre en coloris spéciaux, à partir de 6 pièces Gestell: Sonderlackierung nach Kundenwunsch, ab 6 Stück <small>Price on request for special varnish finishes / Pour vernis spécifiques, devis sur requête / Sonderlackfarben auf Anfrage</small>	VERN	+83 PTS

Cove fully upholstered chair, sled metal base

Chaise tapissée Cove, luge métal

Cove Stuhl gepolstert, Schlittengestell Metall

COVE

FULLY UPHOLSTERED SHELL
COQUE TAPISSÉE
GEPOLSTERTE SCHALE

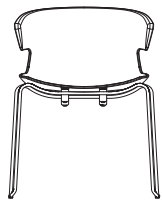

60

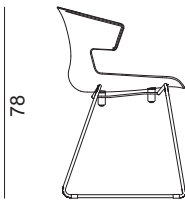

51

78

46

Cod. OCOVEV22

8mm polypropylene shell; injection moulded polyurethane foam; frame made from Ø11mm steel tube; polyethylene glides.

Coque en polypropylène ép. 8mm; rembourrage avec mousse en polyuréthane expansée; cadre en métal Ø 11mm; patins en polyéthylène.

Innenschale aus 8 mm starkem Polypropylen; Polsterung aus geschäumtem Polyurethan; Rahmen aus Stahlrohr Ø11 mm; FüÙe aus Polyethylen.



1M fire retardant B01 fabric upholstered shell



1 box
1 u. x box
0,170 M³



6,50
8,50

UPHOLSTERY / REVETEMENT / BEZUG

B01/B03	C01/C05	D02/D03	E01	P01
494 PTS	540 PTS	565 PTS	612 PTS	623 PTS

UPHOLSTERY ON REQUEST / REVETEMENT SUR REQUETE / ÜBERZUG AUF ANFRAGE

D04	E02/E03	I01/I02	M02/M03
565 PTS	612 PTS	765 PTS	845 PTS

FRAME / CADRE / GESTELL

	Chrome frame Cadre chromé Verchromtes Gestell	FSC12	=
	Powder coated frame in silver Cadre verni alu Gestell Aluminium lackiert	FSG12	=
	Powder coated frame in white Cadre verni blanc Gestell Weiß lackiert	FSB12	=
	Powder coated frame in anthracite Cadre verni gris ombre Gestell Dunkelgrau lackiert	FST12	=

ACCESSORIES / ACCESSOIRES / ZUBEHÖR

	Linking device Accrochage pour chaises Verbinder für Stühle	ACC07	+2 PTS
---	--	-------	--------

ON REQUEST ONLY / SUR REQUETE / AUF ANFRAGE

	Gold powder coated frame Structure vernie or Gestell Gold lackiert	OR	+131 PTS
	Bronze powder coated frame Structure vernie bronze Gestell Bronze lackiert	BR	+131 PTS

COVE

FULLY UPHOLSTERED SHELL
COQUE TAPISSÉE
GEPOLSTERTE SCHALE

Cove fully upholstered chair, sled metal base
Chaise tapissée Cove, luge métal
Cove Stuhl gepolstert, Schlittengestell Metall

ON REQUEST ONLY / SUR REQUETE / AUF ANFRAGE



Corten powder coated frame
Structure vernie corten
Gestell Corten lackiert

CO

+131 PTS



Powder coated frame in a special finish, 6-unit minimum order
Cadre en coloris spéciaux, à partir de 6 pièces
Gestell: Sonderlackierung nach Kundenwunsch, ab 6 Stück

Price on request for special varnish finishes / Pour vernis spécifiques, devis sur requête / Sonderlackfarben auf Anfrage

VERN

+83 PTS

Cove fully upholstered chair, 4 wooden legs
 Chaise tapissée Cove, 4 pieds bois
 Cove Stuhl gepolstert, 4-Fuß Gestell aus Holz

COVE

FULLY UPHOLSTERED SHELL
 COQUE TAPISSÉE
 GEPOLSTERTE SCHALE

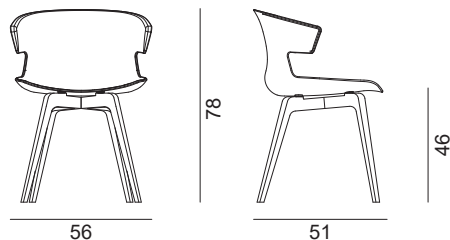

Cod. OCOVEV23

8mm polypropylene shell; injection moulded polyurethane foam; base made from varnished solid beech wood; nylon glides.

Coque en polypropylène ép. 8mm; rembourrage avec mousse en polyuréthane expansée; cadre en hêtre massif verni; patins en nylon.

Innenschale aus 8 mm starkem Polypropylen; Polsterung aus geschäumtem Polyurethan; Rahmen aus lackierter massiver Buche; Füße aus Nylon.



1M fire retardant B01 fabric upholstered shell **CATAS** EN 16139 Level 1

2 box
 3 u. x box
 0,410 M³

5,50
 7,50

UPHOLSTERY / REVETEMENT / BEZUG

B01/B03	C01/C05	D02/D03	E01	P01
644 PTS	690 PTS	716 PTS	762 PTS	776 PTS

UPHOLSTERY ON REQUEST / REVETEMENT SUR REQUETE / ÜBERZUG AUF ANFRAGE

D04	E02/E03	I01/I02	M02/M03
716 PTS	762 PTS	916 PTS	996 PTS

FRAME / CADRE / GESTELL

	Oak varnished solid ash wood Frêne massif verni chêne Esche massiv Eiche hell lackiert	FSFK1	=
	Walnut varnished solid ash wood Frêne massif verni noyer canaletto Esche massiv Nussbaum Kanaletto lackiert	FSFN1	=

ACCESSORIES / ACCESSOIRES / ZUBEHÖR

	Nylon feet supplied with felt pads for wooden flooring Patins de feutres en nylon Nylonfüße mit Filzgleiter	ACC10	+8 PTS
--	--	-------	--------

ON REQUEST ONLY / SUR REQUETE / AUF ANFRAGE

	Powder coated frame in a special finish, 10-unit minimum order Cadre en coloris spéciaux, à partir de 10 pièces Gestell: Sonderlackierung nach Kundenwunsch, ab 10 Stück Price on request for special varnish finishes / Pour vernis spécifiques, devis sur requête / Sonderlackfarben auf Anfrage	VERN	+41 PTS
---	--	------	---------

COVE

FULLY UPHOLSTERED SHELL
COQUE TAPISSÉE
GEPOLSTERTE SCHALE

Cove fully upholstered chair, spider swivel frame Chaise tapissée Cove, piètement étoile pivotant Cove Stuhl gepolstert, 4-Fuß Designgestell, drehbar

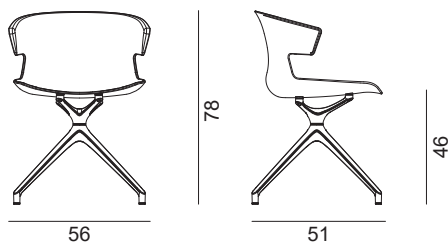

Cod. OCOVEV24

8mm polypropylene shell; injection moulded polyurethane foam; Ø700mm powder coated die-cast aluminium swivel frame; no gas lift; silent nylon glides for carpet or hard flooring.

Coque interne en polypropylène ép.8 mm; rembourrage en polyuréthane expansée à mousse; piètement Ø700mm en alu verni; vérin pivotant sans lift; patins en nylon avec accessoire de glissement sur moquette inclus.

Innenschale aus 8 mm starkem Polypropylen; Polsterung aus geschäumtem Polyurethan; Sockel Ø700 mm aus lackiertem Aluminiumdruckguss; Schwenklift ohne Anhebung; Nylonfüße mit Zubehör zum Aufschieben auf Teppiche im Lieferumfang enthalten.



11M fire retardant B01 fabric upholstered shell



2 box
3 u. x box
0,390 M³



7,00
10,00



UPHOLSTERY / REVETEMENT / BEZUG

B01/B03	C01/C05	D02/D03	E01	P01
664 PTS	708 PTS	736 PTS	781 PTS	795 PTS

UPHOLSTERY ON REQUEST / REVETEMENT SUR REQUETE / ÜBERZUG AUF ANFRAGE

D04	E02/E03	I01/I02	M02/M03
736 PTS	781 PTS	936 PTS	1015 PTS

BASE / BASE / GESTELL

	Powder coated aluminium spider base in silver Piètement 4 branches en alu verni alu avec plaque en teinte 4-Sternfußkreuz Alu pulverbeschichtet mit Unterplatte in gleicher Farbe	BAA08	=
	Powder coated aluminium spider base in white Piètement 4 branches en alu verni blanc avec plaque en teinte 4-Sternfußkreuz Weiß pulverbeschichtet mit Unterplatte in gleicher Farbe	BAA09	=
	Powder coated aluminium spider base in anthracite Piètement 4 branches en alu verni gris ombre avec plaque en teinte 4-Sternfußkreuz Dunkelgrau pulverbeschichtet mit Unterplatte in gleicher Farbe	BAA14	=

ACCESSORIES / ACCESSOIRES / ZUBEHÖR

	Felt pads Patins de feutre Filzgleiter	ACC14	+2 PTS
---	---	--------------	--------

Cove fully upholstered chair, 5-star swivel frame on castors
 Chaise tapissée Cove, base pivotante 5 branches sur roulettes
 Cove Stuhl gepolstert, 5 Sternfuß auf Rollen

COVE

FULLY UPHOLSTERED SHELL
 COQUE TAPISSÉE
 GEPOLSTERTE SCHALE

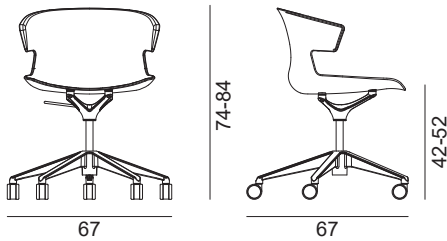

Cod. OCOVEA21

8mm polypropylene shell; injection moulded polyurethane foam; aluminium plate under the seat; gas lift.

Coque en polypropylène ép. 8mm; rembourrage avec mousse en polyuréthane expansée à mousse; plaque en alu; vérin à gaz lift.

Innenschale aus 8 mm starkem Polypropylen; Polsterung aus geschäumtem Polyurethan; Aluminiumplatte; Gasfeder.



11M fire retardant B01 fabric upholstered shell **CATAS** EN 16139 Level 1

1 box
 1 u. x box
 0,190 M³

8,00
 10,00
 KG

UPHOLSTERY / REVETEMENT / BEZUG

B01/B03	C01/C05	D02/D03	E01	P01
631 PTS	677 PTS	702 PTS	749 PTS	761 PTS

UPHOLSTERY ON REQUEST / REVETEMENT SUR REQUETE / ÜBERZUG AUF ANFRAGE

D04	E02/E03	I01/I02	M02/M03
702 PTS	749 PTS	903 PTS	983 PTS



BASE / BASE / GESTELL

	Powder coated aluminium 5-star base, silver finish Piètement 5 branches en alu avec plaque en teinte 5-Sternfußkreuz aus Aluminium, Ausführung Silber pulverbeschichtet	BAA10	=
	Powder coated aluminium 5-star base, white finish Piètement 5 branches en alu verni blanc avec plaque en teinte 5-Sternfußkreuz aus Aluminium, Ausführung Weiß pulverbeschichtet	BAA11	=
	Powder coated aluminium 5-star base, anthracite finish Piètement 5 branches en alu verni gris ombre avec plaque en teinte 5-Sternfußkreuz aus Aluminium, Ausführung Dunkelgrau pulverbeschichtet	BAA15	=

ACCESSORIES / ACCESSOIRES / ZUBEHÖR

	65mmØ twin wheel brake unloaded hard black castors Roulettes standard Ø65mm- autofreinées Standard-Rollen Ø65mm - selbstbremsend	RG06	=
	65mmØ twin wheel brake unloaded soft black castors Roulettes sol dur Ø65mm - autofreinées Gummirollen Ø65mm - selbstbremsend	RG02	+25 PTS
	60mmØ twin wheel unbraked white soft castors Roulettes sol dur blanches Ø60mm - libres Weiße Gummirollen Ø60mm	RG07	+33 PTS
	60mmØ twin wheel unbraked silver soft castors Roulettes sol dur alu Ø60mm - libres Aluminium-Gummirollen Ø60mm	RG08	+33 PTS
	65mmØ twin wheel brake unloaded ring-shaped white soft castors Roulettes "ring" sol dur blanches Ø65mm - autofreinées Weiß gummierte "Ring"-Rollen Ø65mm - selbstbremsend	RG09	+51 PTS

ACCESSORIES / ACCESSOIRES / ZUBEHÖR

	65mmØ twin wheel brake unloaded ring-shaped soft silver castors Roulettes "ring" sol dur alu Ø65mm - autofreinées Gummierte Aluminium "Ring"-Rollen Ø65mm - selbstbremsend	RG10	+51 PTS
	65mmØ twin wheel brake unloaded ring-shaped soft black castors Roulettes "ring" sol dur noires Ø65mm - autofreinées Schwarz gummierte "Ring"-Rollen Ø65mm - selbstbremsend	RG12	+51 PTS
	65mmØ twin wheel brake unloaded ring-shaped soft black/chrome castors - chrome metal hood Roulettes "ring" sol dur chromées/noires Ø65mm - autofreinées Verchromte/schwarze Gummirellen Ø65mm - selbstbremsend	RG11	+56 PTS

Cove fully upholstered 750mm high stool, 4 metal legs

Tabouret Cove tapissé, 4 pieds métal, H 75cm

Cove, Barhocker 4-Fuß Gestell Metall, Gepolstert, Sitzhöhe 75 Cm

COVE

FULLY UPHOLSTERED SHELL
COQUE TAPISSÉE
GEPOLSTERTE SCHALE

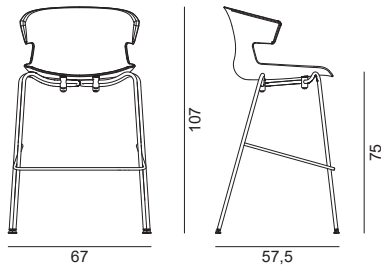

Cod. OCOVES21

8mm polypropylene shell; injection moulded polyurethane foam; frame made from Ø16mm highly resilient chromed steel tube; polyethylene glides.

Coque interne en polypropylène ép. 8mm; rembourrage en polyuréthane expansée; cadre en tube d'acier à haute résistance Ø16mm chromé; patins en polyéthylène.

Innenschale aus 8 mm starkem Polypropylen; Polsterung aus geschäumtem Polyurethan; Gestell aus hochfestem, verchromtem Stahlrohr mit 16 mm Durchmesser; Füße aus Polyethylen.



11M fire retardant B01 fabric upholstered shell **CATAS** EN 16139 Level 1



1 box
1 u. x box
0,340 M³



8,00
11,00

UPHOLSTERY / REVETEMENT / BEZUG

B01/B03	C01/C05	D02/D03	E01	P01
526 PTS	572 PTS	599 PTS	644 PTS	658 PTS

UPHOLSTERY ON REQUEST / REVETEMENT SUR REQUETE / ÜBERZUG AUF ANFRAGE

D04	E02/E03	I01/I02	M02/M03
599 PTS	644 PTS	798 PTS	878 PTS

FRAME / CADRE / GESTELL



Chrome frame
Cadre chromé
Verchromtes Gestell

FSC13

=

ACCESSORIES / ACCESSOIRES / ZUBEHÖR



Set of silent anti-scratch felt pads and glides
Kit de patins de feutres et patins anti-rayures et anti-bruit
Kit kratzfesten und geräuschkämpfenden Filzgleiter.

ACC12

+17 PTS



Articulating adjustable feet complete with felt pads
Patins feutrés dénoués
Gelenkfüße mit Filzgleiter

PD001

+20 PTS

ON REQUEST ONLY / SUR REQUETE / AUF ANFRAGE



Gold powder coated frame
Structure vernie or
Gestell Gold lackiert

OR

+131 PTS



Bronze powder coated frame
Structure vernie bronze
Gestell Bronze lackiert

BR

+131 PTS



Corten powder coated frame
Structure vernie corten
Gestell Corten lackiert

CO

+131 PTS



Powder coated frame in a special finish, 2-unit minimum order
Cadre en coloris spéciaux, à partir de 2 pièces
Gestell: Sonderlackierung nach Kundenwunsch, ab 2 Stück

VERN

+83 PTS

Price on request for special varnish finishes / Pour vernis spécifiques, devis sur requête / Sonderlackfarben auf Anfrage

COVE

FULLY UPHOLSTERED SHELL
COQUE TAPISSÉE
GEPOLSTERTE SCHALE

Cove fully upholstered 650mm high stool, 4 metal legs
Tabouret Cove tapissé, 4 pieds métal, H 65cm
Cove, Barhocker 4-Fuß Gestell Metall, Gepolstert, Sitzhöhe 65 Cm

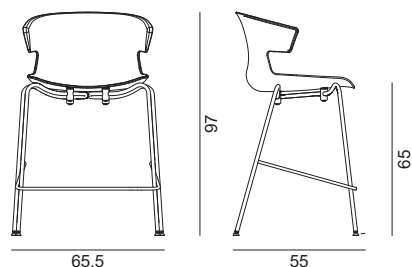

Cod. OCOVES22

8mm polypropylene shell; injection moulded polyurethane foam; frame made from Ø16mm highly resilient chromed steel tube; polyethylene glides.

Coque interne en polypropylène ép. 8mm; rembourrage en polyuréthane expansée; cadre en tube d'acier à haute résistance Ø16mm chromé; patins en polyéthylène.

Innenschale aus 8 mm starkem Polypropylen; Polsterung aus geschäumtem Polyurethan; Gestell aus hochfestem, verchromtem Stahlrohr mit 16 mm Durchmesser; Füße aus Polyethylen.



11M fire retardant B01 fabric upholstered shell **CATAS** EN 16139 Level 1



1 box
1 u. x box
0,340 M³



7,50
10,50

UPHOLSTERY / REVETEMENT / BEZUG

B01/B03	C01/C05	D02/D03	E01	P01
526 PTS	572 PTS	599 PTS	644 PTS	657 PTS



UPHOLSTERY ON REQUEST / REVETEMENT SUR REQUETE / ÜBERZUG AUF ANFRAGE

D04	E02/E03	I01/I02	M02/M03
599 PTS	644 PTS	798 PTS	878 PTS





FRAME / CADRE / GESTELL

	Chrome frame Cadre chromé Verchromtes Gestell	FSC14	=
---	--	--------------	---

ACCESSORIES / ACCESSOIRES / ZUBEHÖR

	Set of silent anti-scratch felt pads and glides Kit de patins de feutres et patins anti-rayures et anti-bruit Kit kratzfesten und geräuschdämpfenden Filzgleiter.	ACC12	+17 PTS
	Articulating adjustable feet complete with felt pads Patins feutrés dénoués Gelenkfüße mit Filzgleiter	PD001	+20 PTS

ON REQUEST ONLY / SUR REQUETE / AUF ANFRAGE

	Gold powder coated frame Structure vernie or Gestell Gold lackiert	OR	+131 PTS
	Bronze powder coated frame Structure vernie bronze Gestell Bronze lackiert	BR	+131 PTS
	Corten powder coated frame Structure vernie corten Gestell Corten lackiert	CO	+131 PTS
	Powder coated frame in a special finish, 2-unit minimum order Cadre en coloris spéciaux, à partir de 2 pièces Gestell: Sonderlackierung nach Kundenwunsch, ab 2 Stück Price on request for special varnish finishes / Pour vernis spécifiques, devis sur requête / Sonderlackfarben auf Anfrage	VERN	+83 PTS

Cove fully upholstered stool, height adjustable swivel base

Tabouret Cove tapissé, base pivotante et vérin

Cove, Barhocker Dreh- Und Höhenverstellbar Gepolstert

COVE

FULLY UPHOLSTERED SHELL
COQUE TAPISSÉE
GEPOLSTERTE SCHALE

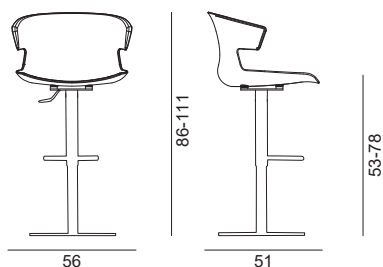

Cod. OCOVES23

8mm polypropylene shell; injection moulded polyurethane foam; steel plate; gas lift; weighted base covered with chrome steel sheet metal with height adjustable footrest.

Coque interne en polypropylène ép. 8mm; rembourrage en polyuréthane expansée; plaque en acier; vérin à gaz lift; piètement avec vérin recouvert en tôle d'acier chromé avec appuie-pieds à élévation.

Innenschale aus 8 mm starkem Polypropylen; Polsterung aus geschäumtem Polyurethan; Stahlplatte; Gasfeder; Sockel mit Schotter bedeckt mit verchromtem Stahlblech mit Fußstütze in Höhe.



1M fire retardant B01 fabric upholstered shell



1 box
1 u. x box
0,350 M³



21,50
24,50

UPHOLSTERY / REVETEMENT / BEZUG

B01/B03	C01/C05	D02/D03	E01	P01
832 PTS	878 PTS	903 PTS	950 PTS	962 PTS

UPHOLSTERY ON REQUEST / REVETEMENT SUR REQUETE / ÜBERZUG AUF ANFRAGE

D04	E02/E03	I01/I02	M02/M03
903 PTS	950 PTS	1103 PTS	1185 PTS

BASE / BASE / GESTELL



Chrome weighted flat base with height adjustable footrest
Piètement chromé avec appuie-pieds et lift
Gestell verchromt, inkl. Fußstütze höhenverstellbar

BAC03

=

COVE

FULLY UPHOLSTERED SHELL
COQUE TAPISSÉE
GEPOLSTERTE SCHALE

Cove fully upholstered stool, 5-star swivel base Tabouret Cove tapissé, base pivotante 5 branches Cove, Barhocker Dreh-Und Höhenverstellbar Gepolstert Mit 5-Sterne Fußkreuz

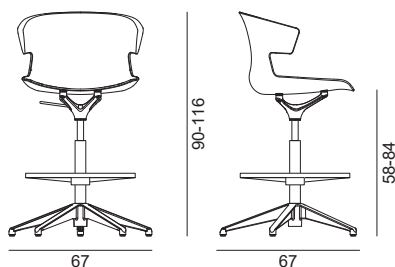

Cod. OCOVES24

8mm polypropylene shell; injection moulded polyurethane foam; gaslift; aluminium plate; height adjustable footrest.

Coque en polypropylène ép. 8mm; rembourrage avec mousse en polyuréthane expansée; piètement en fonte d'aluminium; appuie-pieds réglable en hauteur.

Innenschale aus 8 mm starkem Polypropylen; Polsterung aus geschäumtem Polyurethan; Aluminiumplatte; Fußstütze höhenverstellbar.



11M fire retardant B01 fabric upholstered shell



1 box
1 u. x box
0,190 M³



9,00
11,00

UPHOLSTERY / REVETEMENT / BEZUG

B01/B03	C01/C05	D02/D03	E01	P01
750 PTS	796 PTS	823 PTS	868 PTS	881 PTS

UPHOLSTERY ON REQUEST / REVETEMENT SUR REQUETE / ÜBERZUG AUF ANFRAGE

D04	E02/E03	I01/I02	M02/M03
823 PTS	868 PTS	1022 PTS	1101 PTS

BASE / BASE / GESTELL

	Powder coated aluminium 5-star base, silver finish Piètement 5 branches en alu avec plaque en teinte 5-Sternfußkreuz aus Aluminium, Ausführung Silber pulverbeschichtet	BAA10	=
	Powder coated aluminium 5-star base, white finish Piètement 5 branches en alu verni blanc avec plaque en teinte 5-Sternfußkreuz aus Aluminium, Ausführung Weiß pulverbeschichtet	BAA11	=

Cove fully upholstered 2-person beam seat

Poutre tapissée Cove, 2 places

Cove 2er Bank, gepolstert

COVE

FULLY UPHOLSTERED SHELL
COQUE TAPISSÉE
GEPOLSTERTE SCHALE

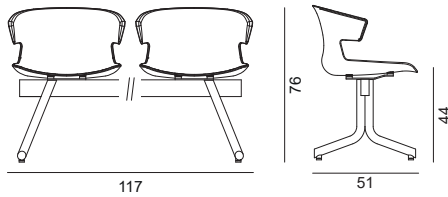

Cod. OCOVE203

8mm polypropylene shell; injection moulded polyurethane foam; 80×40×2mm beam made from powder coated steel tube; 400×2mm powder coated steel legs; polyethylene adjustable levelling feet.

Coque interne en polypropylène ép. 8mm; rembourrage en polyuréthane expansée; poutre en acier 80×40×2 verni à poudre époxy; pieds en tube d'acier 40×2 vernis à poudre époxy; patins réglables en polyéthylène.

Innenschale aus 8 mm starkem Polypropylen; Polsterung aus geschäumtem Polyurethan; Traverse aus 80×40×2 Stahl mit Epoxidpulverlackierung; Beine aus 40×2 Stahlrohr mit Epoxidpulverlackierung; verstellbare FüÙe aus Polyethylen.



1M fire retardant B01 fabric upholstered shell

 1 box
4 u. x box
0,350 M³

 17,00
20,00

UPHOLSTERY / REVETEMENT / BEZUG

B01/B03	C01/C05	D02/D03	E01	P01
1282 PTS	1373 PTS	1425 PTS	1518 PTS	1543 PTS

UPHOLSTERY ON REQUEST / REVETEMENT SUR REQUETE / ÜBERZUG AUF ANFRAGE

D04	E02/E03	I01/I02	M02/M03
1425 PTS	1518 PTS	1825 PTS	1986 PTS

BASE / BASE / GESTELL

	Powder coated frame and beam in silver Piètement verni alu; poutre en teinte Untergestell Metall Alu pulverbeschichtet. Traverse in gleicher Farbe	STR06VA	=
--	---	----------------	---

ACCESSORIES / ACCESSOIRES / ZUBEHÖR

	White MFC table Table blanche en mélamine Couchtisch aus weißem Melamin Takes the place of one seat / Chaque tablette remplace une assise / Jede Tischplatte ersetzt einen Sitzplatz	TAV07	-196 PTS
---	--	--------------	----------

ON REQUEST ONLY / SUR REQUETE / AUF ANFRAGE

	Powder coated frame in a special finish, 2-unit minimum order Cadre en coloris spéciaux, à partir de 2 pièces Gestell: Sonderlackierung nach Kundenwunsch, ab 2 Stück Price on request for special varnish finishes / Pour vernis spécifiques, devis sur requête / Sonderlackfarben auf Anfrage	VERN	+165 PTS
---	---	-------------	----------

COVE

FULLY UPHOLSTERED SHELL
COQUE TAPISSÉE
GEPOLSTERTE SCHALE

Cove fully upholstered 3-person beam seat Poutre tapissée Cove, 3 places Cove 3er Bank, gepolstert

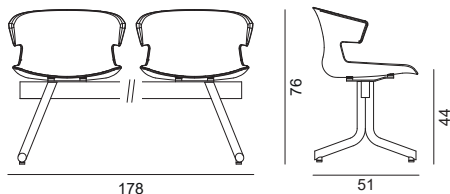

Cod. OCOVE303

8mm polypropylene shell; injection moulded polyurethane foam; 80×40×2mm beam made from powder coated steel tube; 400×2mm powder coated steel legs; polyethylene adjustable levelling feet.

Coque interne en polypropylène ép. 8mm; rembourrage en polyuréthane expansée; poutre en acier 80×40×2 verni à poudre époxy; pieds en tube d'acier 40×2 vernis à poudre époxy; patins réglables en polyéthylène.

Innenschale aus 8 mm starkem Polypropylen; Polsterung aus geschäumtem Polyurethan; Traverse aus 80×40×2 Stahl mit Epoxidpulverlackierung; Beine aus 40×2 Stahlrohr mit Epoxidpulverlackierung; verstellbare Füße aus Polyethylen.

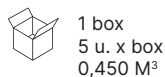

1 box
5 u. x box
0,450 M³



27,00
32,00



1M fire retardant B01 fabric upholstered shell

UPHOLSTERY / REVETEMENT / BEZUG

B01/B03	C01/C05	D02/D03	E01	P01
1748 PTS	1884 PTS	1964 PTS	2102 PTS	2141 PTS

UPHOLSTERY ON REQUEST / REVETEMENT SUR REQUETE / ÜBERZUG AUF ANFRAGE

D04	E02/E03	I01/I02	M02/M03
1964 PTS	2102 PTS	2563 PTS	2805 PTS

BASE / BASE / GESTELL

	Powder coated frame and beam in silver Piètement verni alu; poutre en teinte Untergestell Metall Alu pulverbeschichtet. Traverse in gleicher Farbe	STR06VA	=
--	---	---------	---

ACCESSORIES / ACCESSOIRES / ZUBEHÖR

	White MFC table Table blanche en mélamine Couchtisch aus weißem Melamin Takes the place of one seat / Chaque tablette remplace une assise / Jede Tischplatte ersetzt einen Sitzplatz	TAV07	-196 PTS
--	--	-------	----------

ON REQUEST ONLY / SUR REQUETE / AUF ANFRAGE

	Powder coated frame in a special finish, 2-unit minimum order Cadre en coloris spéciaux, à partir de 2 pièces Gestell: Sonderlackierung nach Kundenwunsch, ab 2 Stück Price on request for special varnish finishes / Pour vernis spécifiques, devis sur requête / Sonderlackfarben auf Anfrage	VERN	+165 PTS
--	---	------	----------

Cove fully upholstered 4-person beam seat

Poutre tapissée Cove, 4 places

Cove 4er Bank, gepolstert

COVE

FULLY UPHOLSTERED SHELL
COQUE TAPISSÉE
GEPOLSTERTE SCHALE

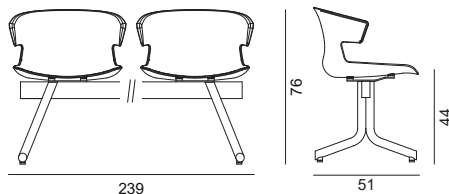

Cod. OCOVE403

8mm polypropylene shell; injection moulded polyurethane foam; 80×40×2mm beam made from powder coated steel tube; 400×2mm powder coated steel legs; polyethylene adjustable levelling feet.

Coque interne en polypropylène ép. 8mm; rembourrage en polyuréthane expansée; poutre en acier 80×40×2 verni à poudre époxy; pieds en tube d'acier 40×2 vernis à poudre époxy; patins réglables en polyéthylène.

Innenschale aus 8 mm starkem Polypropylen; Polsterung aus geschäumtem Polyurethan; Traverse aus 80×40×2 Stahl mit Epoxidpulverlackierung; Beine aus 40×2 Stahlrohr mit Epoxidpulverlackierung; verstellbare FüÙe aus Polyethylen.

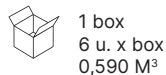

1 box
6 u. x box
0,590 M³



29,00
34,00



1M fire retardant B01 fabric upholstered shell

UPHOLSTERY / REVETEMENT / BEZUG

B01/B03	C01/C05	D02/D03	E01	P01
2226 PTS	2407 PTS	2512 PTS	2698 PTS	2752 PTS

UPHOLSTERY ON REQUEST / REVETEMENT SUR REQUETE / ÜBERZUG AUF ANFRAGE

D04	E02/E03	I01/I02	M02/M03
2512 PTS	2698 PTS	3314 PTS	3635 PTS

BASE / BASE / GESTELL

	Powder coated frame and beam in silver Piètement verni alu; poutre en teinte Untergestell Metall Alu pulverbeschichtet. Traverse in gleicher Farbe	STR06VA	=
--	---	---------	---

ACCESSORIES / ACCESSOIRES / ZUBEHÖR

	White MFC table Table blanche en mélamine Couchtisch aus weißem Melamin Takes the place of one seat / Chaque tablette remplace une assise / Jede Tischplatte ersetzt einen Sitzplatz	TAV07	-196 PTS
--	--	-------	----------

ON REQUEST ONLY / SUR REQUETE / AUF ANFRAGE

	Powder coated frame in a special finish, 2-unit minimum order Cadre en coloris spéciaux, à partir de 2 pièces Gestell: Sonderlackierung nach Kundenwunsch, ab 2 Stück Price on request for special varnish finishes / Pour vernis spécifiques, devis sur requête / Sonderlackfarben auf Anfrage	VERN	+165 PTS
--	---	------	----------

COVE

FULLY UPHOLSTERED SHELL
COQUE TAPISSÉE
GEPOLSTERTE SCHALE

Cove outdoor chair
Chaise Cove outdoor
Cove Stuhl Outdoor

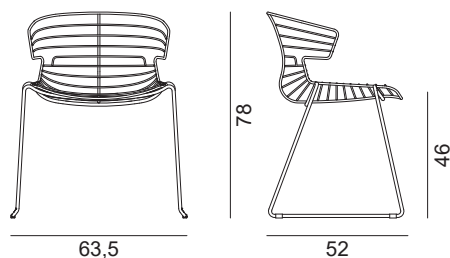

Cod. OCOVEO01

Frame made from Ø12, Ø8 and Ø6mm zinc plated steel rods; use for outdoor (except rain); polyethylene glides.

Structure en acier Ø12, Ø8 et Ø6 mm galvanisé verni pour l'extérieur; patins en polyéthylène.

Stahlrohrgestell Ø12, Ø8 und Ø6 lackiert verzinkt für den Outdoor-Bereich; Gleiter aus Polyethylen.

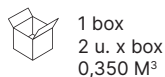

1 box
2 u. x box
0,350 M³



14,00
17,00

FRAME / CADRE / GESTELL

	Powder coated frame in white Cadre verni blanc Gestell Weiß lackiert	FSB12	371 PTS
	Powder coated frame in anthracite Cadre verni gris ombre Gestell Dunkelgrau lackiert	FST12	371 PTS

ACCESSORIES / ACCESSOIRES / ZUBEHÖR

	B03 simil leather upholstered large soft pad Assise rembourrée tapissée avec simili cuir B03 Gepolsterter Sitz, Kunstleder B03	CU2B	+113 PTS
---	---	-------------	----------

ON REQUEST ONLY / SUR REQUETE / AUF ANFRAGE

	Powder coated frame in a special finish, 50-unit minimum order Cadre en coloris spéciaux, à partir de 50 pièces Gestell: Sonderlackierung nach Kundenwunsch, ab 50 Stück	VERN	+41 PTS
---	---	-------------	---------

Price on request for special varnish finishes / Pour vernis spécifiques, devis sur requête / Sonderlackfarben auf Anfrage

Clue polypropylene chair, 4 metal legs
 Chaise en polypropylène Clue, 4 pieds métal
 Clue Stuhl, 4-Fuß Metallgestell

CLUE

FULL POLYPROPYLENE SHELL
 COQUE EN POLYPROPYLENE
 SCHALE AUS POLYPROPYLEN

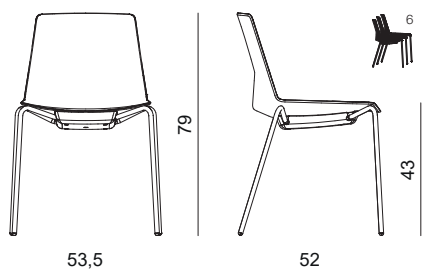

Cod. OCLUEV01

8mm polypropylene shell; frame made from Ø16mm highly resilient steel tube; polyethylene glides; polypropylene cover to the underside of the seat includes rubber spacers for stacking.

Coque interne en polypropylène ép. 8 mm; cadre en tube d'acier à haute résistance Ø16mm; patins en polyéthylène; sous-assise en polypropylène avec entretoises de protection en caoutchouc pour empilabilité.

Schale aus Polypropylen, Stärke 8 mm; Rahmen aus hochfestem Stahlrohr, Ø16 mm; FüÙe aus Polyethylen; Unterseite aus Polypropylen mit Schutzgummi für Stapelbarkeit.

1 box
 2 u. x box
 0,170 M³

KG
 10,00
 11,50

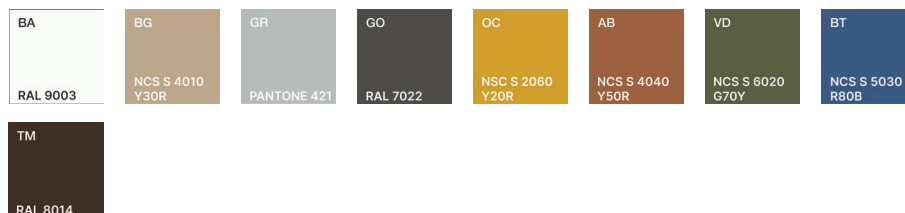

Grey polypropylene cover with BA and GO shell; anthracite with all other polypropylene finishes. Depending on the surface the color may vary slightly from the reference (RAL / NCS) provided.

Sous-assise grise par coque BA et GO; gris ombre dans tous autres cas. En fonction de la surface, la couleur peut varier légèrement par rapport à la référence (RAL / NCS) fournie.



Untere Platte in der Farbe grau für Sitzschale BA und GO; für alle anderen Fällen schattengrau. Je nach Oberfläche kann die Farbe in Bezug auf die RAL/NCS Referenz abweichen.

CATAS UNI EN 16139 Level 1





FRAME / CADRE / GESTELL			
	Chrome frame Cadre chromé Verchromtes Gestell	FSC18	155 PTS
	Powder coated frame in silver Cadre verni alu Gestell Aluminium lackiert	FSG18	155 PTS
	Powder coated frame in white Cadre verni blanc Gestell Weiß lackiert	FSB18	155 PTS
	Powder coated frame in anthracite Cadre verni gris ombre Gestell Dunkelgrau lackiert	FST18	155 PTS

ACCESSORIES / ACCESSOIRES / ZUBEHÖR						
	B01/B03 fabric/faux leather upholstered small soft pad in the shown colors Coussin revêtu en tissu/textile enduit B01/B03 (dans les revêtements indiqués) Gepolstertes Kissen mit Stoff/Kunstleder Kat. B01/B03 bezogen (in den angegebenen Farben)	CU4B	+46 PTS			
B01: 009 / 010 / 012 / 013 / 018 / 023 / 027 / 028 / 222 B03: 138 / 141 / 170 / 175 / 179 / 181 / 182 / 183		B01 & B03 finishes which do not show are available on request, 12 unit minimum order: furter +17 pts upcharge / Les revêtements B01 et B03 non indiqués, sont disponibles sur requête, min. 12 pièces: +17 pts / Die Farben aus der Kategorie B01 bzw. B03, die hier nicht angegeben sind, sind auf Anfrage erhältlich, ab 12 Stück: + 17 Pkte				
	Upholstered front of seat and back Rembourrage frontal fixe Feste Frontpolsterung	B01/B03 CU3B	C01/C05 CU3C	D02/D03 CU3D	E01 CU3E	P01 CU3P1
Non-stackable / Pas empilable / Nicht stapelbar		+173 PTS	+189 PTS	+199 PTS	+210 PTS	+299 PTS
	Fixed front padding, upholstery on request Rembourrage frontal fixe, revêtement sur demande Vordere Polsterung fest, Überzug auf Anfrage	D04/D06 CU3D	E02/E03/E04 CU3E	I01/I02 CU3I	M02/M03 CU3M	
Non-stackable / Pas empilable / Nicht stapelbar		+199 PTS	+210 PTS	+277 PTS	+311 PTS	

ACCESSORIES / ACCESSOIRES / ZUBEHÖR

	<p>Articulating adjustable feet complete with felt pads Patins feutrés dénoués <i>GelenkfüÙe mit Filzgleiter</i></p>	<p>PD001</p>	<p>+20 PTS</p>
	<p>Set of silent anti-scratch felt pads and glides Kit de patins de feutres et patins anti-rayures et anti-bruit <i>Kit kratzfesten und geräuscdämpfenden Filzgleiter.</i></p>	<p>ACC12</p>	<p>+17 PTS</p>

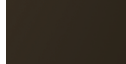
ON REQUEST ONLY / SUR REQUETE / AUF ANFRAGE

	<p>Fire retardant shell, 300-unit minimum order in one color Version non-feu, à partir de 300 pièces <i>Feuerfeste Ausführung, mindestens 300 Schalen pro Farbe</i></p>	<p>IGNI</p>	<p>+28 PTS</p>
	<p>Gold powder coated frame Structure vernie or <i>Gestell Gold lackiert</i></p>	<p>OR</p>	<p>+131 PTS</p>
	<p>Bronze powder coated frame Structure vernie bronze <i>Gestell Bronze lackiert</i></p>	<p>BR</p>	<p>+131 PTS</p>
	<p>Corten powder coated frame Structure vernie corten <i>Gestell Corten lackiert</i></p>	<p>CO</p>	<p>+131 PTS</p>
	<p>Powder coated frame in a special finish, 6-unit minimum order Cadre en coloris spéciaux, à partir de 6 pièces <i>Gestell: Sonderlackierung nach Kundenwunsch, ab 6 Stück</i></p> <p><small>Price on request for special varnish finishes / Pour vernis spécifiques, devis sur requête / Sonderlackfarben auf Anfrage</small></p>	<p>VERN</p>	<p>+83 PTS</p>

Clue polypropylene chair, 4 metal legs with integral arms
 Chaise en polypropylène Clue, 4 pieds métal avec accoudoirs
 Clue Stuhl, 4-Fuß Metallgestell mit Armlehnen

CLUE

FULL POLYPROPYLENE SHELL
 COQUE EN POLYPROPYLENE
 SCHALE AUS POLYPROPYLEN

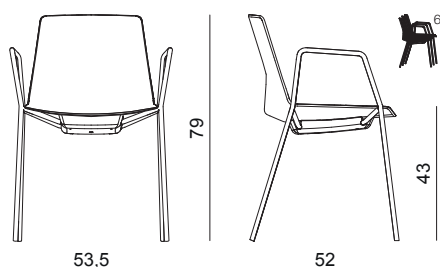

Cod. OCLUEV06

8mm polypropylene shell; frame made from Ø16mm highly resilient steel tube with integral arms; polyethylene glides; polypropylene cover to the underside of the seat includes rubber spacers for stacking.

Coque en polypropylène ép.8 mm; tube en acier à haute résistance Ø16mm avec accoudoirs; patins en polyéthylène; sous-assise en polypropylène avec entretoises de protection en caoutchouc pour empilabilité.

Schale aus Polypropylen, Stärke 8 mm; Rahmen aus hochfestem Stahlrohr, Ø16 mm, mit Armlehnen; Füße aus Polyethylen; untere Sitzplatte aus Polypropylen mit Schutzgummi für Stapelbarkeit.

1 box
 2 u. x box
 0,280 M³

11,00
 13,50

BA RAL 9003	BG NCS S 4010 Y30R	GR PANTONE 421	GO RAL 7022	OC NSC S 2060 Y20R	AB NCS S 4040 Y50R	VD NCS S 6020 G70Y	BT NCS S 5030 R80B
TM RAL 8014							

Grey polypropylene cover with BA and GO shell; anthracite with all other polypropylene finishes. Depending on the surface the color may vary slightly from the reference (RAL / NCS) provided.

Sous-assise grise par coque BA et GO; gris ombre dans tous autres cas. En fonction de la surface, la couleur peut varier légèrement par rapport à la référence (RAL / NCS) fournie.

Untere Platte in der Farbe grau für Sitzschale BA und GO; für alle anderen Fällen schattengrau. Je nach Oberfläche kann die Farbe in Bezug auf die RAL/NCS Referenz abweichen.



FRAME / CADRE / GESTELL

	Chrome frame with integral arms Cadre avec accoudoirs chromés Verchromtes Gestell mit Armlehnen	FSC19	249 PTS
	Frame with integral arms, powder coated in silver Cadre avec accoudoirs vernis en alu Gestell mit Armlehnen aus lackiertem Aluminium	FSG19	249 PTS
	Frame with integral arms, powder coated in white Cadre avec accoudoirs vernis en blanc Gestell mit weiß lackierten Armlehnen	FSB19	249 PTS
	Frame with integral arms, powder coated in anthracite Cadre avec accoudoirs vernis en gris ombre Gestell mit Armlehnen Dunkelgrau lackiert	FST19	249 PTS





ACCESSORIES / ACCESSOIRES / ZUBEHÖR

	B01/B03 fabric/faux leather upholstered small soft pad in the shown colors Coussin revêtu en tissu/textile enduit B01/B03 (dans les revêtements indiqués) Gepolstertes Kissen mit Stoff/Kunstleder Kat. B01/B03 bezogen (in den angegebenen Farben)	CU4B	+46 PTS			
<p>B01: 009 / 010 / 012 / 013 / 018 / 023 / 027 / 028 / 222 B03: 138 / 141 / 170 / 175 / 179 / 181 / 182 / 183</p> <p><small>B01 & B03 finishes which do not show are available on request, 12 unit minimum order: furter +17 pts upcharge / Les revêtements B01 et B03 non indiqués, sont disponibles sur requête, min. 12 pièces: +17 pts / Die Farben aus der Kategorie B01 bzw. B03, die hier nicht angegeben sind, sind auf Anfrage erhältlich, ab 12 Stück: + 17 Pkte</small></p>						
	Upholstered front of seat and back Rembourrage frontal fixe, revêtement sur demande Feste Frontpolsterung	B01/B03 CU3B	C01/C05 CU3C	D02/D03 CU3D	E01 CU3E	P01 CU3P1
	Non-stackable / Pas empilable / Nicht stapelbar	+173 PTS	+189 PTS	+199 PTS	+210 PTS	+299 PTS
	Fixed front padding, upholstery on request Rembourrage frontal fixe, revêtement sur demande Vordere Polsterung fest, Überzug auf Anfrage	D04/D06 CU3D	E02/E03/E04 CU3E	I01/I02 CU3I	M02/M03 CU3M	
	Non-stackable / Pas empilable / Nicht stapelbar	+199 PTS	+210 PTS	+277 PTS	+311 PTS	

ACCESSORIES / ACCESSOIRES / ZUBEHÖR

	<p>Articulating adjustable feet complete with felt pads Patins feutrés dénoués <i>Gelenkfüße mit Filzgleiter</i></p>	<p>PD001</p>	<p>+20 PTS</p>
	<p>Set of silent anti-scratch felt pads and glides Kit de patins de feutres et patins anti-rayures et anti-bruit <i>Kit kratzfesten und geräuschkämpfenden Filzgleiter.</i></p>	<p>ACC12</p>	<p>+17 PTS</p>

ON REQUEST ONLY / SUR REQUETE / AUF ANFRAGE

	<p>Fire retardant shell, 300-unit minimum order in one color Version non-feu, à partir de 300 pièces <i>Feuerfeste Ausführung, mindestens 300 Schalen pro Farbe</i></p>	<p>IGNI</p>	<p>+28 PTS</p>
	<p>Gold powder coated frame Structure vernie or <i>Gestell Gold lackiert</i></p>	<p>OR</p>	<p>+131 PTS</p>
	<p>Bronze powder coated frame Structure vernie bronze <i>Gestell Bronze lackiert</i></p>	<p>BR</p>	<p>+131 PTS</p>
	<p>Corten powder coated frame Structure vernie corten <i>Gestell Corten lackiert</i></p>	<p>CO</p>	<p>+131 PTS</p>
	<p>Powder coated frame in a special finish, 6-unit minimum order Cadre en coloris spéciaux, à partir de 6 pièces <i>Gestell: Sonderlackierung nach Kundenwunsch, ab 6 Stück</i></p> <p><small>Price on request for special varnish finishes / Pour vernis spécifiques, devis sur requête / Sonderlackfarben auf Anfrage</small></p>	<p>VERN</p>	<p>+83 PTS</p>

Clue polypropylene chair, sled metal base
 Chaise en polypropylène Clue, luge métal
 Clue Stuhl, Metallkufengestell

CLUE

FULL POLYPROPYLENE SHELL
 COQUE EN POLYPROPYLÈNE
 SCHALE AUS POLYPROPYLEN

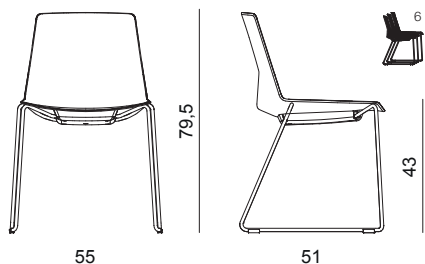

Cod. OCLUEV02

8mm polypropylene shell; frame made from Ø12mm steel tube; polyethylene glides; polypropylene cover to the underside of the seat includes rubber spacers for stacking.

Coque interne en polypropylène ép. 8 mm; cadre en tube d'acier Ø12mm; patins en polyéthylène; sous-assise en polypropylène avec entretoises de protection en caoutchouc pour empilabilité

8 mm Stärker Polypropylenmantel; Ø12 mm Stahlrohrrahmen; Polyethylenfüße; Polypropylenunterboden mit Schutzdichtungen für Stapelbarkeit.

1 box
 2 u. x box
 0,170 M³

14,00
 15,50

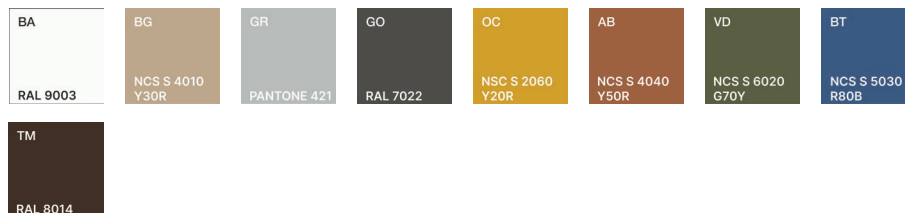

Grey polypropylene cover with BA and GO shell; anthracite with all other polypropylene finishes. Depending on the surface the color may vary slightly from the reference (RAL / NCS) provided.





Sous-assise grise par coque BA et GO; gris ombre dans tous autres cas. En fonction de la surface, la couleur peut varier légèrement par rapport à la référence (RAL / NCS) fournie.

Untere Platte in der Farbe grau für Sitzschale BA und GO; für alle anderen Fällen schattengrau. Je nach Oberfläche kann die Farbe in Bezug auf die RAL/NCS Referenz abweichen.

CATAS UNI EN 16139 Level 1, UNI EN 1022, UNI EN 1728

FRAME / CADRE / GESTELL						
	Chrome frame Cadre chromé Verchromtes Gestell		FSC20		183 PTS	
	Powder coated frame in silver Cadre verni alu Gestell Aluminium lackiert		FSG20		183 PTS	
	Powder coated frame in white Cadre verni blanc Gestell Weiß lackiert		FSB20		183 PTS	
	Powder coated frame in anthracite Cadre verni gris ombre Gestell Dunkelgrau lackiert		FST20		183 PTS	
ACCESSORIES / ACCESSOIRES / ZUBEHÖR						
	B01/B03 fabric/faux leather upholstered small soft pad in the shown colors Coussin revêtu en tissu/textile enduit B01/B03 (dans les revêtements indiqués) Gepolstertes Kissen mit Stoff/Kunstleder Kat. B01/B03 bezogen (in den angegebenen Farben)		CU4B		+46 PTS	
B01: 009 / 010 / 012 / 013 / 018 / 023 / 027 / 028 / 222 B03: 138 / 141 / 170 / 175 / 179 / 181 / 182 / 183		B01 & B03 finishes which do not show are available on request, 12 unit minimum order: further +17 pts upcharge / Les revêtements B01 et B03 non indiqués, sont disponibles sur requête, min. 12 pièces: +17 pts / Die Farben aus der Kategorie B01 bzw. B03, die hier nicht angegeben sind, sind auf Anfrage erhältlich, ab 12 Stück: + 17 Pkte				
	Upholstered front of seat and back Rembourrage frontal fixe Feste Frontpolsterung	B01/B03 CU3B	C01/C05 CU3C	D02/D03 CU3D	E01 CU3E	P01 CU3P1
Non-stackable / Pas empilable / Nicht stapelbar		+173 PTS	+189 PTS	+199 PTS	+210 PTS	+299 PTS
	Fixed front padding, upholstery on request Rembourrage frontal fixe, revêtement sur demande Vordere Polsterung fest, Überzug auf Anfrage		D04/D06 CU3D	E02/E03/E04 CU3E	I01/I02 CU3I	M02/M03 CU3M
Non-stackable / Pas empilable / Nicht stapelbar		+199 PTS	+210 PTS	+277 PTS	+311 PTS	

ON REQUEST ONLY / SUR REQUETE / AUF ANFRAGE

	<p>Fire retardant shell, 300-unit minimum order in one color Version non-feu, à partir de 300 pièces <i>Feuerfeste Ausführung, mindestens 300 Schalen pro Farbe</i></p>	IGNI	+28 PTS
	<p>Gold powder coated frame Structure vernie or <i>Gestell Gold lackiert</i></p>	OR	+131 PTS
	<p>Bronze powder coated frame Structure vernie bronze <i>Gestell Bronze lackiert</i></p>	BR	+131 PTS
	<p>Corten powder coated frame Structure vernie corten <i>Gestell Corten lackiert</i></p>	CO	+131 PTS
	<p>Powder coated frame in a special finish, 6-unit minimum order Cadre en coloris spéciaux, à partir de 6 pièces <i>Gestell: Sonderlackierung nach Kundenwunsch, ab 6 Stück</i></p> <p><small>Price on request for special varnish finishes / Pour vernis spécifiques, devis sur requête / Sonderlackfarben auf Anfrage</small></p>	VERN	+83 PTS

Clue polypropylene chair, 4 wooden legs
 Chaise en polypropylène Clue, 4 pieds bois
 Clue Stuhl, 4-Fuß Holzgestell

CLUE

FULL POLYPROPYLENE SHELL
 COQUE EN POLYPROPYLÈNE
 SCHALE AUS POLYPROPYLEN

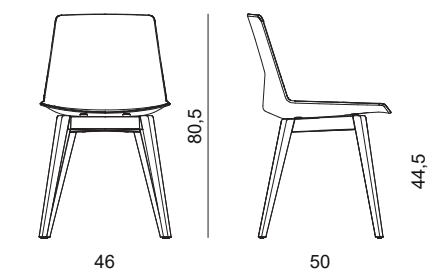

Cod. OCLUEV03

8mm polypropylene shell; base made from varnished solid ash wood; nylon glides.

Coque en polypropylène ép. 8mm; cadre en frêne massif verni; patins en nylon.

Polypropylenschale, Stärke 8mm; Rahmen aus lackierter massiver Esche; FüÙe aus Nylon.

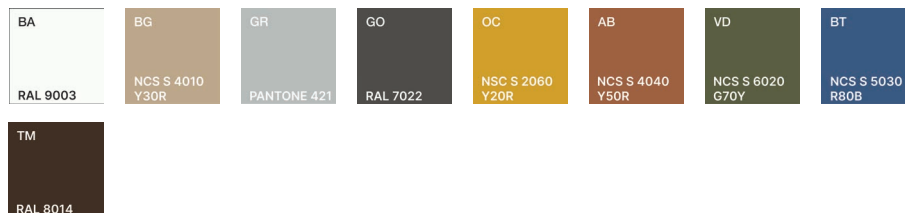

2 box
 2 u. x box
 0,240 M³

10,00
 12,00

Depending on the surface the color may vary slightly from the reference (RAL / NCS) provided.
 En fonction de la surface, la couleur peut varier légèrement par rapport à la référence (RAL / NCS) fournie.
 Je nach Oberfläche kann die Farbe in Bezug auf die RAL/NCS Referenz abweichen.

CATAS UNI EN 16139, UNI EN 1022, UNI EN 1728

FRAME / CADRE / GESTELL

	Oak varnished solid ash wood Frêne massif verni chêne Esche massiv Eiche hell lackiert	FSFK2	296 PTS
	Walnut varnished solid ash wood Frêne massif verni noyer canaletto Esche massiv Nussbaum Kanaletto lackiert	FSFN2	296 PTS

ACCESSORIES / ACCESSOIRES / ZUBEHÖR

	B01/B03 fabric/faux leather upholstered small soft pad in the shown colors Coussin revêtu en tissu/textile enduit B01/B03 (dans les revêtements indiqués) Gepolstertes Kissen mit Stoff/Kunstleder Kat. B01/B03 bezogen (in den angegebenen Farben)	CU4B	+46 PTS			
<small>B01 & B03 finishes which do not show are available on request, 12 unit minimum order: furter +17 pts upcharge / Les revêtements B01 et B03 non indiqués, sont disponibles sur requête, min. 12 pièces: +17 pts / Die Farben aus der Kategorie B01 bzw. B03, die hier nicht angegeben sind, sind auf Anfrage erhältlich, ab 12 Stück: + 17 Pkte</small>						
	Upholstered front of seat and back Rembourrage frontal fixe Feste Frontpolsterung	B01/B03 CU3B	C01/C05 CU3C	D02/D03 CU3D	E01 CU3E	P01 CU3P1
Non-stackable / Pas empilable / Nicht stapelbar		+173 PTS	+189 PTS	+199 PTS	+210 PTS	+299 PTS
	Fixed front padding, upholstery on request Rembourrage frontal fixe, revêtement sur demande Vordere Polsterung fest, Überzug auf Anfrage	D04/D06 CU3D	E02/E03/E04 CU3E	I01/I02 CU3I	M02/M03 CU3M	
Non-stackable / Pas empilable / Nicht stapelbar		+199 PTS	+210 PTS	+277 PTS	+311 PTS	
	Nylon feet supplied with felt pads for wooden flooring Patins de feutres en nylon NylonfüÙe mit Filzgleiter	ACC10	+8 PTS			

ON REQUEST ONLY / SUR REQUETE / AUF ANFRAGE

	Fire retardant shell, 300-unit minimum order in one color Version non-feu, à partir de 300 pièces Feuerfeste Ausführung, mindestens 300 Schalen pro Farbe	IGNI	+28 PTS
	Powder coated frame in a special finish, 10-unit minimum order Cadre en coloris spéciaux, à partir de 10 pièces Gestell: Sonderlackierung nach Kundenwunsch, ab 10 Stück	VERN	+41 PTS
<small>Price on request for special varnish finishes / Pour vernis spécifiques, devis sur requête / Sonderlackfarben auf Anfrage</small>			

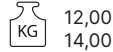
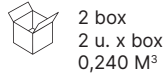
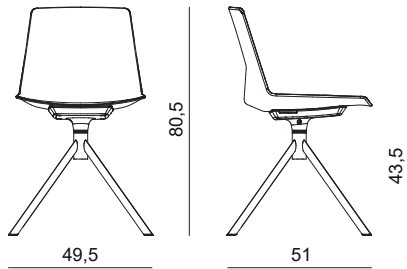

Cod. OCLUEV04

8mm polypropylene shell; steel reinforced nylon plate; spider base made from 2mm 30×15mm elliptical steel tube; polypropylene glides with felt pads.

Coque en polypropylène ép.8 mm; plaque en nylon et acier; piètement en tube elliptique d'acier 30×15 ép.2 mm; patins feutrés en polypropylène.

Polypropylenschale, Stärke 8mm; Nylonplatte verstärkt mit Stahl; Beine aus elliptischem Rohr aus 30×15 Stahl, Stärke 2mm; Füße aus Polypropylen mit Filzgleitern.



Depending on the surface the color may vary slightly from the reference (RAL / NCS) provided.
En fonction de la surface, la couleur peut varier légèrement par rapport à la référence (RAL / NCS) fournie.
Je nach Oberfläche kann die Farbe in Bezug auf die RAL/NCS Referenz abweichen.

BASE / BASE / GESTELL

	Chromed steel spider base, plate in silver Piètement en acier chromé, plaque en alu Verchromtes Stahlbockgestell, alufarbene Platte	BAF01	302 PTS
	Steel spider base, powder coated in silver, matching plate Piètement en acier verni alu, plaque en teinte Stahlbockgestell aus Stahl lackiertem Aluminium, Platte in gleicher Farbe	BAF02	302 PTS
	Steel spider base, powder coated in white, matching plate Piètement en acier verni blanc, plaque en teinte Stahlbockgestell aus weiß lackiertem Stahl, Platte in gleicher Farbe	BAF03	302 PTS
	Steel spider base, powder coated in anthracite, matching plate Piètement en acier verni gris ombre, plaque en teinte Stahlbockgestell aus stahlgrau lackiertem Schatten, Platte in gleicher Farbe	BAF04	302 PTS





ACCESSORIES / ACCESSOIRES / ZUBEHÖR

	B01/B03 fabric/faux leather upholstered small soft pad in the shown colors Coussin revêtu en tissu/textile enduit B01/B03 (dans les revêtements indiqués) Gepolstertes Kissen mit Stoff/Kunstleder Kat. B01/B03 bezogen (in den angegebenen Farben)	CU4B	+46 PTS			
<p>B01: 009 / 010 / 012 / 013 / 018 / 023 / 027 / 028 / 222 B03: 138 / 141 / 170 / 175 / 179 / 181 / 182 / 183</p> <p><small>B01 & B03 finishes which do not show are available on request, 12 unit minimum order: further +17 pts upcharge / Les revêtements B01 et B03 non indiqués, sont disponibles sur requête, min. 12 pièces: +17 pts / Die Farben aus der Kategorie B01 bzw. B03, die hier nicht angegeben sind, sind auf Anfrage erhältlich, ab 12 Stück: +17 Pkte</small></p>						
	Upholstered front of seat and back Rembourrage frontal fixe Feste Frontpolsterung	B01/B03 CU3B	C01/C05 CU3C	D02/D03 CU3D	E01 CU3E	P01 CU3P1
		+173 PTS	+189 PTS	+199 PTS	+210 PTS	+299 PTS
<small>Non-stackable / Pas empilable / Nicht stapelbar</small>						
	Fixed front padding, upholstery on request Rembourrage frontal fixe, revêtement sur demande Vordere Polsterung fest, Überzug auf Anfrage		D04/D06 CU3D	E02/E03/E04 CU3E	I01/I02 CU3I	M02/M03 CU3M
			+199 PTS	+210 PTS	+277 PTS	+311 PTS
<small>Non-stackable / Pas empilable / Nicht stapelbar</small>						
	Chrome steel armrest Accoudoir en acier chromé Verchromte Armlehne aus Stahl	BRF15CR	+134 PTS			

Clue polypropylene chair, spider metal frame
 Chaise en polypropylène Clue, piètement étoile pivotant métal
 Clue Stuhl, 4-Fuß Designgestell aus Stahl

CLUE

FULL POLYPROPYLENE SHELL
 COQUE EN POLYPROPYLENE
 SCHALE AUS POLYPROPYLEN

ACCESSORIES / ACCESSOIRES / ZUBEHÖR		
	Silver painted steel armrest Accoudoir en acier verni alu Armlehne aus Stahl Aluminium lackiert	BRF15VA +134 PTS
	White painted steel armrest Accoudoir en acier verni blanc Armlehne aus Stahl Weiß lackiert	BRF15VB +134 PTS
	Anthracite painted steel armrest Accoudoir en acier verni gris ombre Armlehne aus Stahl Dunkelgrau lackiert	BRF15VO +134 PTS
	Die-cast brushed aluminium armrest Accoudoir en alu brossé Armlehne aus gebürstetem Aluminiumdruckguss	BRF16 +156 PTS
ON REQUEST ONLY / SUR REQUETE / AUF ANFRAGE		
	Fire retardant shell, 300-unit minimum order in one color Version non-feu, à partir de 300 pièces Feuerfeste Ausführung, mindestens 300 Schalen pro Farbe	IGNI +28 PTS

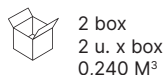
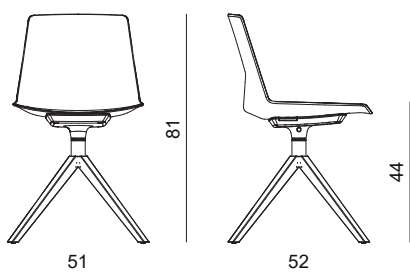

Cod. OCLUEV05

8mm polypropylene shell; steel reinforced nylon plate; powder coated steel swivel column; spider base made from varnished solid ash wood; nylon glides.

Coque en polypropylène ép.8 mm; plaque en nylon et acier; rotor en acier verni; piètement en frêne massif verni; patins en nylon.

Polypropylen-Schale, Stärke 8mm; Nylonplatte verstärkt mit Stahl; Rotor aus lackiertem Stahl; Beine aus lackierter massiver Esche; Füße aus Nylon.

BA RAL 9003	BG NCS S 4010 Y30R	GR PANTONE 421	GO RAL 7022	OC NSC S 2060 Y20R	AB NCS S 4040 Y50R	VD NCS S 6020 G70Y	BT NCS S 5030 R80B
TM RAL 8014							

Depending on the surface the color may vary slightly from the reference (RAL / NCS) provided.
En fonction de la surface, la couleur peut varier légèrement par rapport à la référence (RAL / NCS) fournie.
Je nach Oberfläche kann die Farbe in Bezug auf die RAL/NCS Referenz abweichen.

BASE / BASE / GESTELL

	Oak varnished solid ash wood legs, anthracite painted metal column with matching box under the seat Piètement en frêne verni chêne, rotor verni blanc avec plaque en teinte Gestell aus Eiche hell-lackierter Esche, Weiß lackierte Drehplatte Gestell Esche Eiche hell lackiert, Weiß lackierte Drehplatte	BAL05	524 PTS
	Oak varnished solid ash wood legs, white painted metal column with matching box under the seat Piètement en frêne verni chêne, rotor verni gris ombre avec plaque en teinte Gestell aus Eiche hell-lackierter Esche, Dunkelgrau lackierte Drehplatte Gestell Esche Eiche hell lackiert, Dunkelgrau lackierte Drehplatte	BAL06	524 PTS
	Walnut varnished solid ash wood legs, anthracite painted metal column with matching box under the seat Piètement en frêne verni noyer canaletto, rotor verni blanc avec plaque en teinte Gestell Esche Nußbaum Kanaletto lackiert, Weiß lackierte Drehplatte	BAL03	524 PTS
	Walnut varnished solid ash wood legs, white painted metal column with matching box under the seat Piètement en frêne verni noyer canaletto, rotor verni gris ombre avec plaque en teinte Gestell Esche Nußbaum Kanaletto lackiert, Dunkelgrau lackierte Drehplatte	BAL04	524 PTS

ACCESSORIES / ACCESSOIRES / ZUBEHÖR

	B01/B03 fabric/faux leather upholstered small soft pad in the shown colors Coussin revêtu en tissu/textile enduit B01/B03 (dans les revêtements indiqués) Gepolstertes Kissen mit Stoff/Kunstleder Kat. B01/B03 bezogen (in den angegebenen Farben)	CU4B	+46 PTS										
<p>B01: 009 / 010 / 012 / 013 / 018 / 023 / 027 / 028 / 222 B03: 138 / 141 / 170 / 175 / 179 / 181 / 182 / 183</p> <p>B01 & B03 finishes which do not show are available on request, 12 unit minimum order: further +17 pts upcharge / Les revêtements B01 et B03 non indiqués, sont disponibles sur requête, min. 12 pièces: +17 pts / Die Farben aus der Kategorie B01 bzw. B03, die hier nicht angegeben sind, sind auf Anfrage erhältlich, ab 12 Stück: + 17 Pkte</p>													
	Upholstered front of seat and back Rembourrage frontal fixe, revêtement sur demande Feste Frontpolsterung	<table border="1"> <tr> <td>B01/B03 CU3B</td> <td>C01/C05 CU3C</td> <td>D02/D03 CU3D</td> <td>E01 CU3E</td> <td>P01 CU3P1</td> </tr> <tr> <td>+173 PTS</td> <td>+189 PTS</td> <td>+199 PTS</td> <td>+210 PTS</td> <td>+299 PTS</td> </tr> </table>	B01/B03 CU3B	C01/C05 CU3C	D02/D03 CU3D	E01 CU3E	P01 CU3P1	+173 PTS	+189 PTS	+199 PTS	+210 PTS	+299 PTS	
B01/B03 CU3B	C01/C05 CU3C	D02/D03 CU3D	E01 CU3E	P01 CU3P1									
+173 PTS	+189 PTS	+199 PTS	+210 PTS	+299 PTS									
	Fixed front padding, upholstery on request Rembourrage frontal fixe, revêtement sur demande Vordere Polsterung fest, Überzug auf Anfrage	<table border="1"> <tr> <td>D04/D06 CU3D</td> <td>E02/E03/E04 CU3E</td> <td>I01/I02 CU3I</td> <td>M02/M03 CU3M</td> </tr> <tr> <td>+199 PTS</td> <td>+210 PTS</td> <td>+277 PTS</td> <td>+311 PTS</td> </tr> </table>	D04/D06 CU3D	E02/E03/E04 CU3E	I01/I02 CU3I	M02/M03 CU3M	+199 PTS	+210 PTS	+277 PTS	+311 PTS			
D04/D06 CU3D	E02/E03/E04 CU3E	I01/I02 CU3I	M02/M03 CU3M										
+199 PTS	+210 PTS	+277 PTS	+311 PTS										
	Chrome steel armrest Accoudoir en acier chromé Verchromte Armlehne aus Stahl	BRF15CR	+134 PTS										





Clue polypropylene chair, spider wooden frame

Chaise en polypropylène Clue, piètement étoile pivotant bois

Clue Stuhl, 4-Fuß Designgestell aus Holz

CLUE

FULL POLYPROPYLENE SHELL
COQUE EN POLYPROPYLENE
SCHALE AUS POLYPROPYLEN

ACCESSORIES / ACCESSOIRES / ZUBEHÖR		
	Silver painted steel armrest Accoudoir en acier verni alu <i>Armlehne aus Stahl Aluminium lackiert</i>	BRF15VA +134 PTS
	White painted steel armrest Accoudoir en acier verni blanc <i>Armlehne aus Stahl Weiß lackiert</i>	BRF15VB +134 PTS
	Anthracite painted steel armrest Accoudoir en acier verni gris ombre <i>Armlehne aus Stahl Dunkelgrau lackiert</i>	BRF15VO +134 PTS
	Die-cast brushed aluminium armrest Accoudoir en alu brossé <i>Armlehne aus gebürstetem Aluminiumdruckguss</i>	BRF16 +156 PTS
	Nylon feet supplied with felt pads for wooden flooring Patins de feutres en nylon <i>Nylonfüße mit Filzgleiter</i>	ACC10 +8 PTS

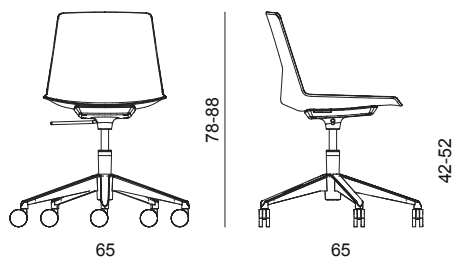

Cod. OCLUEA01

8mm polypropylene shell; steel reinforced nylon plate; gas lift.

Coque en polypropylène ép. 8 mm; plaque en nylon et acier; vérin à gaz lift.

Polypropylen-Schale, Stärke 8mm; Nylonplatte mit Stahlverstärkung; Gasfeder.



1 box
1 u. x box
0,140 M³

7,50
9,00

Depending on the surface the color may vary slightly from the reference (RAL / NCS) provided.

En fonction de la surface, la couleur peut varier légèrement par rapport à la référence (RAL / NCS) fournie.

Je nach Oberfläche kann die Farbe in Bezug auf die RAL/NCS Referenz abweichen.

BASE / BASE / GESTELL

	Powder coated aluminium 5-star base, silver finish Piètement 5 branches en alu avec plaque en teinte 5-Sternfußkreuz aus Aluminium, Ausführung Silber pulverbeschichtet	BAA10	296 PTS
	Powder coated aluminium 5-star base, white finish Piètement 5 branches en alu verni blanc avec plaque en teinte 5-Sternfußkreuz aus Aluminium, Ausführung Weiß pulverbeschichtet	BAA11	296 PTS
	Powder coated aluminium 5-star base, anthracite finish Piètement 5 branches en alu verni gris ombre avec plaque en teinte 5-Sternfußkreuz aus Aluminium, Ausführung Dunkelgrau pulverbeschichtet	BAA15	296 PTS

ACCESSORIES / ACCESSOIRES / ZUBEHÖR

	B01/B03 fabric/faux leather upholstered small soft pad in the shown colors Coussin revêtu en tissu/textile enduit B01/B03 (dans les revêtements indiqués) Gepolstertes Kissen mit Stoff/Kunstleder Kat. B01/B03 bezogen (in den angegebenen Farben)	CU4B	+46 PTS										
B01: 009 / 010 / 012 / 013 / 018 / 023 / 027 / 028 / 222 B03: 138 / 141 / 170 / 175 / 179 / 181 / 182 / 183		B01 & B03 finishes which do not show are available on request, 12 unit minimum order: further +17 pts upcharge / Les revêtements B01 et B03 non indiqués, sont disponibles sur requête, min. 12 pièces: +17 pts / Die Farben aus der Kategorie B01 bzw. B03, die hier nicht angegeben sind, sind auf Anfrage erhältlich, ab 12 Stück: + 17 Pkte											
	Upholstered front of seat and back Rembourrage frontal fixe Feste Frontpolsterung Non-stackable / Pas empilable / Nicht stapelbar	<table border="1"> <tr> <td>B01/B03 CU3B</td> <td>C01/C05 CU3C</td> <td>D02/D03 CU3D</td> <td>E01 CU3E</td> <td>P01 CU3P1</td> </tr> <tr> <td>+173 PTS</td> <td>+189 PTS</td> <td>+199 PTS</td> <td>+210 PTS</td> <td>+299 PTS</td> </tr> </table>	B01/B03 CU3B	C01/C05 CU3C	D02/D03 CU3D	E01 CU3E	P01 CU3P1	+173 PTS	+189 PTS	+199 PTS	+210 PTS	+299 PTS	
B01/B03 CU3B	C01/C05 CU3C	D02/D03 CU3D	E01 CU3E	P01 CU3P1									
+173 PTS	+189 PTS	+199 PTS	+210 PTS	+299 PTS									
	Fixed front padding, upholstery on request Rembourrage frontal fixe, revêtement sur demande Vordere Polsterung fest, Überzug auf Anfrage Non-stackable / Pas empilable / Nicht stapelbar	<table border="1"> <tr> <td>D04/D06 CU3D</td> <td>E02/E03/E04 CU3E</td> <td>I01/I02 CU3I</td> <td>M02/M03 CU3M</td> </tr> <tr> <td>+199 PTS</td> <td>+210 PTS</td> <td>+277 PTS</td> <td>+311 PTS</td> </tr> </table>	D04/D06 CU3D	E02/E03/E04 CU3E	I01/I02 CU3I	M02/M03 CU3M	+199 PTS	+210 PTS	+277 PTS	+311 PTS			
D04/D06 CU3D	E02/E03/E04 CU3E	I01/I02 CU3I	M02/M03 CU3M										
+199 PTS	+210 PTS	+277 PTS	+311 PTS										
	Chrome steel armrest Accoudoir en acier chromé Verchromte Armlehne aus Stahl	BRF15CR	+134 PTS										
	Silver painted steel armrest Accoudoir en acier verni alu Armlehne aus Stahl Aluminium lackiert	BRF15VA	+134 PTS										
	White painted steel armrest Accoudoir en acier verni blanc Armlehne aus Stahl Weiß lackiert	BRF15VB	+134 PTS										











Clue polypropylene chair, 5-star swivel frame on castors

Chaise en polypropylène Clue, base pivotante 5 branches sur roulettes

Clue Stuhl, 5 Sternfuß auf Rollen

CLUE

FULL POLYPROPYLENE SHELL
COQUE EN POLYPROPYLENE
SCHALE AUS POLYPROPYLEN

ACCESSORIES / ACCESSOIRES / ZUBEHÖR			
	Anthracite painted steel armrest Accoudoir en acier verni gris ombre <i>Armlehne aus Stahl Dunkelgrau lackiert</i>	BRF15VO	+134 PTS
	Die-cast brushed aluminium armrest Accoudoir en alu brossé <i>Armlehne aus gebürstetem Aluminiumdruckguss</i>	BRF16	+156 PTS
	65mmØ twin wheel brake unloaded hard black castors Roulettes standard Ø65mm - autofreinées <i>Standard-Rollen Ø65mm - selbstbremsend</i>	RG06	=
	65mmØ twin wheel brake unloaded soft black castors Roulettes sol dur Ø65mm - autofreinées <i>Gummirollen Ø65mm - selbstbremsend</i>	RG02	+25 PTS
	60mmØ twin wheel unbraked white soft castors Roulettes sol dur blanches Ø60mm - libres <i>Weiß GummRollen Ø60mm</i>	RG07	+33 PTS
	60mmØ twin wheel unbraked silver soft castors Roulettes sol dur alu Ø60mm - libres <i>Aluminium-Gummirollen Ø60mm</i>	RG08	+33 PTS
	65mmØ twin wheel brake unloaded ring-shaped white soft castors Roulettes "ring" sol dur blanches Ø65mm - autofreinées <i>Weiß gummierte "Ring"-Rollen Ø65mm - selbstbremsend</i>	RG09	+51 PTS
	65mmØ twin wheel brake unloaded ring-shaped soft silver castors Roulettes "ring" sol dur alu Ø65mm - autofreinées <i>Gummierte Aluminium "Ring"-Rollen Ø65mm - selbstbremsend</i>	RG10	+51 PTS
	65mmØ twin wheel brake unloaded ring-shaped soft black castors Roulettes "ring" sol dur noires Ø65mm - autofreinées <i>Schwarz gummierte "Ring"-Rollen Ø65mm - selbstbremsend</i>	RG12	+51 PTS
	65mmØ twin wheel brake unloaded ring-shaped soft black/chrome castors - chrome metal hood Roulettes "ring" sol dur chromées/noires Ø65mm - autofreinées <i>Verchromte/schwarze Gummirollen Ø65mm - selbstbremsend</i>	RG11	+56 PTS
	White HPL 360° swivel tablet; for left and right hand users. Tablette orbitale ergonomique en HPL en blanc <i>Ergonomischer Schreibtäbler in weißem HPL</i>	TAV14	+191 PTS

 UNI EN 16139 Level 2 Extreme use

ON REQUEST ONLY / SUR REQUETE / AUF ANFRAGE			
	Fire retardant shell, 300-unit minimum order in one color Version non-feu, à partir de 300 pièces <i>Feuerfeste Ausführung, mindestens 300 Schalen pro Farbe</i>	IGNI	+28 PTS

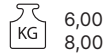
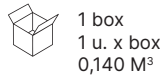
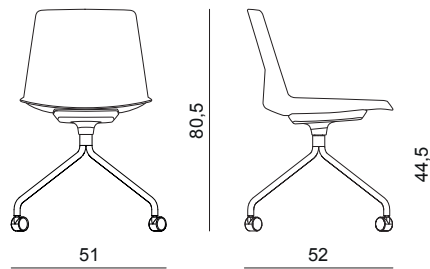

Cod. OCLUEA02

8mm polypropylene shell; steel reinforced nylon plate; frame made from Ø22mm chromed or powder coated steel tube.

Coque en polypropylène ép. 8 mm; plaque en nylon et acier; cadre en tube d'acier Ø22 chromé ou verni.

Polypropylen-Schale, Stärke 8mm; Nylonplatte verstärkt mit Stahl; Rahmen aus Stahlrohr Ø22, verchromt oder lackiert.



Depending on the surface the color may vary slightly from the reference (RAL / NCS) provided.
En fonction de la surface, la couleur peut varier légèrement par rapport à la référence (RAL / NCS) fournie.
Je nach Oberfläche kann die Farbe in Bezug auf die RAL/NCS Referenz abweichen.

BASE / BASE / GESTELL

	4-star base on castors, chromed, plate in silver Base 4 roulettes chromée avec plaque en alu 4-Sternfußkreuz verchromt mit Aluminium Unterplatte	BAF05	296 PTS
	4-star base on castors, powder coated in silver with matching plate Base 4 roulettes vernie alu avec plaque en teinte 4-Sternfußkreuz Alu pulverbeschichtet mit Unterplatte in gleicher Farbe	BAF06	296 PTS
	4-star base on castors, powder coated in white with matching plate Base 4 roulettes vernie en blanc avec plaque en teinte 4-Sternfußkreuz Weiß pulverbeschichtet mit Unterplatte in gleicher Farbe	BAF07	296 PTS
	4-star base on castors, powder coated in anthracite with matching plate Base 4 roulettes vernie en gris ombre avec plaque en teinte 4-Sternfußkreuz Dunkelgrau pulverbeschichtet mit Unterplatte in gleicher Farbe	BAF08	296 PTS













ACCESSORIES / ACCESSOIRES / ZUBEHÖR

	B01/B03 fabric/faux leather upholstered small soft pad in the shown colors Coussin revêtu en tissu/textile enduit B01/B03 (dans les revêtements indiqués) Gepolstertes Kissen mit Stoff/Kunstleder Kat. B01/B03 bezogen (in den angegebenen Farben)	CU4B	+46 PTS			
<p>B01: 009 / 010 / 012 / 013 / 018 / 023 / 027 / 028 / 222 B03: 138 / 141 / 170 / 175 / 179 / 181 / 182 / 183</p> <p><small>B01 & B03 finishes which do not show are available on request, 12 unit minimum order: further +17 pts upcharge / Les revêtements B01 et B03 non indiqués, sont disponibles sur requête, min. 12 pièces: +17 pts / Die Farben aus der Kategorie B01 bzw. B03, die hier nicht angegeben sind, sind auf Anfrage erhältlich, ab 12 Stück: +17 Pkte</small></p>						
	Upholstered front of seat and back Rembourrage frontal fixe Feste Frontpolsterung	B01/B03 CU3B	C01/C05 CU3C	D02/D03 CU3D	E01 CU3E	P01 CU3P1
	Non-stackable / Pas empilable / Nicht stapelbar	+173 PTS	+189 PTS	+199 PTS	+210 PTS	+299 PTS
	Fixed front padding, upholstery on request Rembourrage frontal fixe, revêtement sur demande Vordere Polsterung fest, Überzug auf Anfrage		D04/D06 CU3D	E02/E03/E04 CU3E	I01/I02 CU3I	M02/M03 CU3M
	Non-stackable / Pas empilable / Nicht stapelbar		+199 PTS	+210 PTS	+277 PTS	+311 PTS
	Chrome steel armrest Accoudoir en acier chromé Verchromte Armlehne aus Stahl	BRF15CR				+134 PTS

Clue polypropylene chair, 4-star base on castors
Chaise en polypropylène Clue, piètement 4 roulettes
Clue Stuhl, 4 Sternfuß auf Rollen

CLUE

FULL POLYPROPYLENE SHELL
 COQUE EN POLYPROPYLÈNE
 SCHALE AUS POLYPROPYLEN

ACCESSORIES / ACCESSOIRES / ZUBEHÖR			
	Silver painted steel armrest Accoudoir en acier verni alu <i>Armlehne aus Stahl Aluminium lackiert</i>	BRF15VA	+134 PTS
	White painted steel armrest Accoudoir en acier verni blanc <i>Armlehne aus Stahl Weiß lackiert</i>	BRF15VB	+134 PTS
	Anthracite painted steel armrest Accoudoir en acier verni gris ombre <i>Armlehne aus Stahl Dunkelgrau lackiert</i>	BRF15VO	+134 PTS
	Die-cast brushed aluminium armrest Accoudoir en alu brossé <i>Armlehne aus gebürstetem Aluminiumdruckguss</i>	BRF16	+156 PTS
	65mmØ twin wheel brake unloaded hard black castors Roulettes standard Ø65mm- autofreinées <i>Standard-Rollen Ø65mm - selbstbremsend</i>	RG06	=
	65mmØ twin wheel brake unloaded soft black castors Roulettes sol dur Ø65mm - autofreinées <i>Gummirollen Ø65mm - selbstbremsend</i>	RG02	+25 PTS
	60mmØ twin wheel unbraked white soft castors Roulettes sol dur blanches Ø60mm - libres <i>Weiß Gummiirollen Ø60mm</i>	RG07	+33 PTS
	60mmØ twin wheel unbraked silver soft castors Roulettes sol dur alu Ø60mm - libres <i>Aluminium-Gummiirollen Ø60mm</i>	RG08	+33 PTS
	65mmØ twin wheel brake unloaded ring-shaped white soft castors Roulettes "ring" sol dur blanches Ø65mm - autofreinées <i>Weiß gummierte "Ring"-Rollen Ø65mm - selbstbremsend</i>	RG09	+51 PTS
	65mmØ twin wheel brake unloaded ring-shaped soft silver castors Roulettes "ring" sol dur alu Ø65mm - autofreinées <i>Gummierte Aluminium "Ring"-Rollen Ø65mm - selbstbremsend</i>	RG10	+51 PTS
	65mmØ twin wheel brake unloaded ring-shaped soft black castors Roulettes "ring" sol dur noires Ø65mm - autofreinées <i>Schwarz gummierte "Ring"-Rollen Ø65mm - selbstbremsend</i>	RG12	+51 PTS
	65mmØ twin wheel brake unloaded ring-shaped soft black/chrome castors - chrome metal hood Roulettes "ring" sol dur chromées/noires Ø65mm - autofreinées <i>Verchromte/schwarze Gummiirollen Ø65mm - selbstbremsend</i>	RG11	+56 PTS

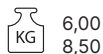
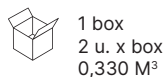
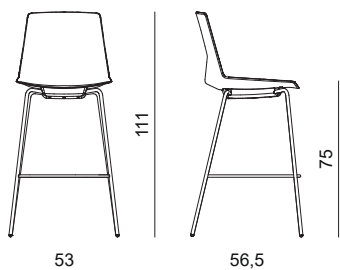

Cod. OCLUES01

8mm polypropylene shell; frame made from Ø16mm highly resilient chromed steel tube; polyethylene glides; polypropylene cover to the underside of the seat.

Coque en polypropylène ép. 8 mm; cadre en tube d'acier à haute résistance Ø16 chromé; patins en polyéthylène; sous-assise en polypropylène.

Schale aus Polypropylen, Stärke 8 mm; Rahmen aus hochfestem Stahlrohr Ø16 mm verchromt; Füße aus Polyethylen; unterer Sitz aus Polypropylen.

BA RAL 9003	BG NCS S 4010 Y30R	GR PANTONE 421	GO RAL 7022	OC NSC S 2060 Y20R	AB NCS S 4040 Y50R	VD NCS S 6020 G70Y	BT NCS S 5030 R80B
TM RAL 8014							

Depending on the surface the color may vary slightly from the reference (RAL / NCS) provided.
En fonction de la surface, la couleur peut varier légèrement par rapport à la référence (RAL / NCS) fournie.
Je nach Oberfläche kann die Farbe in Bezug auf die RAL/NCS Referenz abweichen.

FRAME / CADRE / GESTELL



Chrome frame
Cadre chromé
Verchromtes Gestell

FSC21

258 PTS

ACCESSORIES / ACCESSOIRES / ZUBEHÖR



B01/B03 fabric/faux leather upholstered small soft pad in the shown colors
Coussin revêtu en tissu/textile enduit B01/B03 (dans les revêtements indiqués)
Gepolstertes Kissen mit Stoff/Kunstleder Kat. B01/B03 bezogen (in den angegebenen Farben)

CU4B

+46 PTS

B01: 009 / 010 / 012 / 013 / 018 / 023 / 027 / 028 / 222
B03: 138 / 141 / 170 / 175 / 179 / 181 / 182 / 183

B01 & B03 finishes which do not show are available on request, 12 unit minimum order: further +17 pts upcharge / Les revêtements B01 et B03 non indiqués, sont disponibles sur requête, min. 12 pièces: +17 pts / Die Farben aus der Kategorie B01 bzw. B03, die hier nicht angegeben sind, sind auf Anfrage erhältlich, ab 12 Stück: + 17 Pkte



Upholstered front of seat and back
Rembourrage frontal fixe
Feste Frontpolsterung

Non-stackable / Pas empilable / Nicht stapelbar

B01/B03 CU3B	C01/C05 CU3C	D02/D03 CU3D	E01 CU3E	P01 CU3P1
+173 PTS	+189 PTS	+199 PTS	+210 PTS	+299 PTS



Fixed front padding, upholstery on request
Rembourrage frontal fixe, revêtement sur demande
Vordere Polsterung fest, Überzug auf Anfrage

Non-stackable / Pas empilable / Nicht stapelbar

D04/D06 CU3D	E02/E03/E04 CU3E	I01/I02 CU3I	M02/M03 CU3M
+199 PTS	+210 PTS	+277 PTS	+311 PTS



Articulating adjustable feet complete with felt pads
Patins feutrés dénoués
Gelenkfüße mit Filzgleiter

PD001

+20 PTS



Set of silent anti-scratch felt pads and glides
Kit de patins de feutres et patins anti-rayures et anti-bruit
Kit kratzfesten und geräuschkämpfenden Filzgleiter.

ACC12

+17 PTS

ON REQUEST ONLY / SUR REQUETE / AUF ANFRAGE



Fire retardant shell, 300-unit minimum order in one color
Version non-feu, à partir de 300 pièces
Feuerfeste Ausführung, mindestens 300 Schalen pro Farbe

IGNI

+28 PTS



Powder coated frame in a special finish, 2-unit minimum order
Cadre en coloris spéciaux, à partir de 2 pièces
Gestell: Sonderlackierung nach Kundenwunsch, ab 2 Stück

Price on request for special varnish finishes / Pour vernis spécifiques, devis sur requête / Sonderlackfarben auf Anfrage

VERN

+83 PTS

Clue polypropylene stool, height adjustable swivel base
Tabouret Clue polypropylène, base pivotante et vérin
Barhocker Clue Polypropylen, dreh- und höhenverstellbar

CLUE

FULL POLYPROPYLENE SHELL
 COQUE EN POLYPROPYLÈNE
 SCHALE AUS POLYPROPYLEN

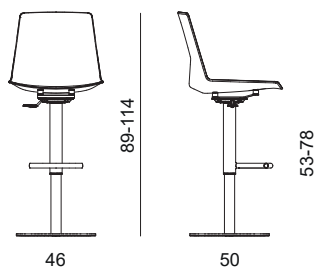

Cod. OCLUES03

8mm polypropylene shell; steel plate; gas lift; weighted base covered with chrome steel sheet metal with height adjustable footrest.

Coque en polypropylène ép. 8 mm; plaque en acier; vérin à gaz lift; piètement avec vérin recouvert en tôle d'acier chromé avec appuie-pieds à élévation.

Sitzschale aus Polypropylen, Stärke 8 mm; Stahlplatte; Gasfeder; Sockel mit Ballast, abgedeckt aus verchromtem Stahlblech mit Fußstütze in der Höhe.

1 box
 1 u. x box
 0,350 M³

18,50
 20,00

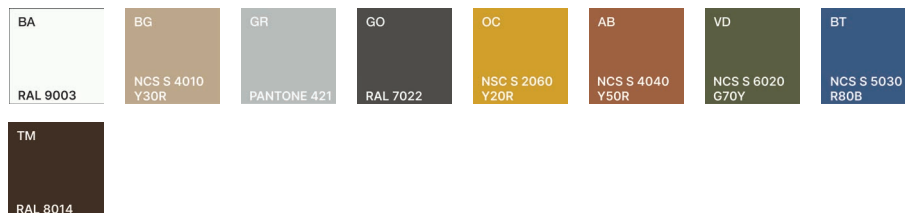

Depending on the surface the color may vary slightly from the reference (RAL / NCS) provided.
 En fonction de la surface, la couleur peut varier légèrement par rapport à la référence (RAL / NCS) fournie.
 Je nach Oberfläche kann die Farbe in Bezug auf die RAL/NCS Referenz abweichen.

BASE / BASE / GESTELL



Chrome weighted flat base with height adjustable footrest
 Piètement chromé avec appuie-pieds et lift
 Gestell verchromt, inkl. Fußstütze höhenverstellbar

BAC03

495 PTS

ACCESSORIES / ACCESSOIRES / ZUBEHÖR



B01/B03 fabric/faux leather upholstered small soft pad in the shown colors
 Coussin revêtu en tissu/textile enduit B01/B03 (dans les revêtements indiqués)
 Gepolstertes Kissen mit Stoff/Kunstleder Kat. B01/B03 bezogen (in den angegebenen Farben)

CU4B

+46 PTS

B01: 009 / 010 / 012 / 013 / 018 / 023 / 027 / 028 / 222
B03: 138 / 141 / 170 / 175 / 179 / 181 / 182 / 183

B01 & B03 finishes which do not show are available on request, 12 unit minimum order: furter +17 pts upcharge / Les revêtements B01 et B03 non indiqués, sont disponibles sur requête, min. 12 pièces: +17 pts / Die Farben aus der Kategorie B01 bzw. B03, die hier nicht angegeben sind, sind auf Anfrage erhältlich, ab 12 Stück: + 17 Pkte



Upholstered front of seat and back
 Rembourrage frontal fixe
 Feste Frontpolsterung

Non-stackable / Pas empilable / Nicht stapelbar

B01/B03 CU3B	C01/C05 CU3C	D02/D03 CU3D	E01 CU3E	P01 CU3P1
+173 PTS	+189 PTS	+199 PTS	+210 PTS	+299 PTS



Fixed front padding, upholstery on request
 Rembourrage frontal fixe, revêtement sur demande
 Vordere Polsterung fest, Überzug auf Anfrage

Non-stackable / Pas empilable / Nicht stapelbar

D04/D06 CU3D	E02/E03/E04 CU3E	I01/I02 CU3I	M02/M03 CU3M
+199 PTS	+210 PTS	+277 PTS	+311 PTS

ON REQUEST ONLY / SUR REQUETE / AUF ANFRAGE



Fire retardant shell, 300-unit minimum order in one color
 Version non-feu, à partir de 300 pièces
 Feuerfeste Ausführung, mindestens 300 Schalen pro Farbe

IGNI

+28 PTS

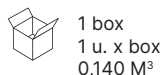
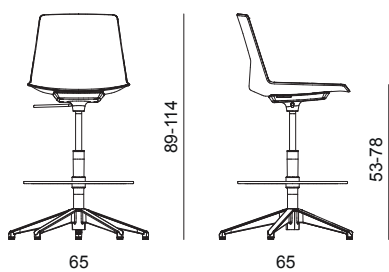

Cod. OCLUES04

8mm polypropylene shell; gaslift; steel reinforced nylon plate; height adjustable footrest.

Coque en polypropylène ép. 8 mm; vérin à gaz lift; plaque en nylon et acier; appuie-pieds réglable en hauteur.

Sitzschale aus Polypropylen, Stärke 8 mm; Gasfeder; Nylonplatte mit Stahlverstärkung; höhenverstellbare Fußstütze.

BA RAL 9003	BG NCS S 4010 Y30R	GR PANTONE 421	GO RAL 7022	OC NSC S 2060 Y20R	AB NCS S 4040 Y50R	VD NCS S 6020 G70Y	BT NCS S 5030 R80B
TM RAL 8014							

Depending on the surface the color may vary slightly from the reference (RAL / NCS) provided.

En fonction de la surface, la couleur peut varier légèrement par rapport à la référence (RAL / NCS) fournie.
Je nach Oberfläche kann die Farbe in Bezug auf die RAL/NCS Referenz abweichen.

BASE / BASE / GESTELL



Powder coated aluminium 5-star base, silver finish
Piètement 5 branches en alu avec plaque en teinte
5-Sternfußkreuz aus Aluminium, Ausführung Silber pulverbeschichtet

BAA10

367 PTS



Powder coated aluminium 5-star base, white finish
Piètement 5 branches en alu verni blanc avec plaque en teinte
5-Sternfußkreuz aus Aluminium, Ausführung Weiß pulverbeschichtet

BAA11

367 PTS

ACCESSORIES / ACCESSOIRES / ZUBEHÖR



B01/B03 fabric/faux leather upholstered small soft pad in the shown colors
Coussin revêtu en tissu/textile enduit B01/B03 (dans les revêtements indiqués)
Gepolstertes Kissen mit Stoff/Kunstleder Kat. B01/B03 bezogen (in den angegebenen Farben)

CU4B

+46 PTS

B01: 009 / 010 / 012 / 013 / 018 / 023 / 027 / 028 / 222
B03: 138 / 141 / 170 / 175 / 179 / 181 / 182 / 183

B01 & B03 finishes which do not show are available on request, 12 unit minimum order: further +17 pts upcharge / Les revêtements B01 et B03 non indiqués, sont disponibles sur requête, min. 12 pièces: +17 pts / Die Farben aus der Kategorie B01 bzw. B03, die hier nicht angegeben sind, sind auf Anfrage erhältlich, ab 12 Stück: + 17 Pkte



Upholstered front of seat and back
Rembourrage frontal fixe
Feste Frontpolsterung

Non-stackable / Pas empilable / Nicht stapelbar

B01/B03
CU3B

+173 PTS

C01/C05
CU3C

+189 PTS

D02/D03
CU3D

+199 PTS

E01
CU3E

+210 PTS

P01
CU3P1

+299 PTS



Fixed front padding, upholstery on request
Rembourrage frontal fixe, revêtement sur demande
Vordere Polsterung fest, Überzug auf Anfrage

Non-stackable / Pas empilable / Nicht stapelbar

D04/D06
CU3D

+199 PTS

E02/E03/E04
CU3E

+210 PTS

I01/I02
CU3I

+277 PTS

M02/M03
CU3M

+311 PTS



Chrome steel armrest
Accoudoir en acier chromé
Verchromte Armlehne aus Stahl

BRF15CR

+134 PTS



Silver painted steel armrest
Accoudoir en acier verni alu
Armlehne aus Stahl Aluminium lackiert

BRF15VA

+134 PTS



White painted steel armrest
Accoudoir en acier verni blanc
Armlehne aus Stahl Weiß lackiert



BRF15VB

+134 PTS

Clue polypropylene stool, 5-star swivel base

Tabouret Clue polypropylène, base pivotante 5 branches

*Barhocker Clue Polypropylen, dreh- und höhenverstellbar auf 5-SternenFußkreuz*FULL POLYPROPYLENE SHELL
COQUE EN POLYPROPYLENE
SCHALE AUS POLYPROPYLEN**ACCESSORIES / ACCESSOIRES / ZUBEHÖR**

	Anthracite painted steel armrest Accoudoir en acier verni gris ombre <i>Armlehne aus Stahl Dunkelgrau lackiert</i>	BRF15VO	+134 PTS
	Die-cast brushed aluminium armrest Accoudoir en alu brossé <i>Armlehne aus gebürstetem Aluminiumdruckguss</i>	BRF16	+156 PTS
ON REQUEST ONLY / SUR REQUETE / AUF ANFRAGE			
	Fire retardant shell, 300-unit minimum order in one color Version non-feu, à partir de 300 pièces <i>Feuerfeste Ausführung, mindestens 300 Schalen pro Farbe</i>	IGNI	+28 PTS

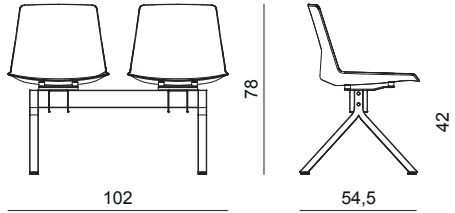

Cod. OCLUE201

8mm polypropylene shell; 80×40×2mm beam made from powder coated steel tube; 400×300×2mm powder coated steel legs; polyethylene adjustable levelling feet.

Coque en polypropylène ép. 8mm; poutre en acier 80×40×2 verni à poudre époxy; piètement en acier 40×30×2 verni à poudre époxy; patins réglables en polyéthylène.

Schale aus Polypropylen, Stärke 8 mm; Stahlträger 80×40×2 epoxidpulverbeschichtet; Stahlbeine 40×30×2 epoxidpulverbeschichtet; verstellbare FüÙe aus Polyethylen.

3 box
1 u. x box
0,160 M³

18,50
20,50

BA RAL 9003	BG NCS S 4010 Y30R	GR PANTONE 421	GO RAL 7022	OC NCS S 2060 Y20R	AB NCS S 4040 Y50R	VD NCS S 6020 G70Y	BT NCS S 5030 R80B
TM RAL 8014							

Depending on the surface the color may vary slightly from the reference (RAL / NCS) provided.
En fonction de la surface, la couleur peut varier légèrement par rapport à la référence (RAL / NCS) fournie.
Je nach Oberfläche kann die Farbe in Bezug auf die RAL/NCS Referenz abweichen.

BASE / BASE / GESTELL

	Powder coated frame and beam in silver Piètement verni alu; poutre en teinte <i>Untergestell Metall Alu pulverbeschichtet. Traverse in gleicher Farbe</i>	STR07VA	736 PTS
	Powder coated frame and beam in anthracite Piètement verni gris ombre; poutre en teinte <i>Untergestell Metall Dunkelgrau pulverbeschichtet. Traverse in gleicher Farbe</i>	STR07VO	736 PTS

ACCESSORIES / ACCESSOIRES / ZUBEHÖR

	B01/B03 fabric/faux leather upholstered small soft pad in the shown colors Coussin revêtu en tissu/textile enduit B01/B03 (dans les revêtements indiqués) <i>Gepolstertes Kissen mit Stoff/Kunstleder Kat. B01/B03 bezogen (in den angegebenen Farben)</i>	CU4B	+46 PTS										
<p>B01: 009 / 010 / 012 / 013 / 018 / 023 / 027 / 028 / 222 B03: 138 / 141 / 170 / 175 / 179 / 181 / 182 / 183</p> <p>B01 & B03 finishes which do not show are available on request, 12 unit minimum order: further +17 pts upcharge / Les revêtements B01 et B03 non indiqués, sont disponibles sur requête, min. 12 pièces: +17 pts / Die Farben aus der Kategorie B01 bzw. B03, die hier nicht angegeben sind, sind auf Anfrage erhältlich, ab 12 Stück: + 17 Pkte</p>													
	Upholstered front of seat and back Rembourrage frontal fixe <i>Feste Frontpolsterung</i>	<table border="1"> <tr> <td>B01/B03 CU3B</td> <td>C01/C05 CU3C</td> <td>D02/D03 CU3D</td> <td>E01 CU3E</td> <td>P01 CU3P1</td> </tr> <tr> <td>+173 PTS</td> <td>+189 PTS</td> <td>+199 PTS</td> <td>+210 PTS</td> <td>+299 PTS</td> </tr> </table>	B01/B03 CU3B	C01/C05 CU3C	D02/D03 CU3D	E01 CU3E	P01 CU3P1	+173 PTS	+189 PTS	+199 PTS	+210 PTS	+299 PTS	
B01/B03 CU3B	C01/C05 CU3C	D02/D03 CU3D	E01 CU3E	P01 CU3P1									
+173 PTS	+189 PTS	+199 PTS	+210 PTS	+299 PTS									
<i>Non-stackable / Pas empilable / Nicht stapelbar</i>		<i>Price refers to one single seat / Prix par chaise / Preis pro Sitz</i>											
	Fixed front padding, upholstery on request Rembourrage frontal fixe, revêtement sur demande <i>Vordere Polsterung fest, Überzug auf Anfrage</i>	<table border="1"> <tr> <td>D04/D06 CU3D</td> <td>E02/E03/E04 CU3E</td> <td>I01/I02 CU3I</td> <td>M02/M03 CU3M</td> </tr> <tr> <td>+199 PTS</td> <td>+210 PTS</td> <td>+277 PTS</td> <td>+311 PTS</td> </tr> </table>	D04/D06 CU3D	E02/E03/E04 CU3E	I01/I02 CU3I	M02/M03 CU3M	+199 PTS	+210 PTS	+277 PTS	+311 PTS			
D04/D06 CU3D	E02/E03/E04 CU3E	I01/I02 CU3I	M02/M03 CU3M										
+199 PTS	+210 PTS	+277 PTS	+311 PTS										
<i>Non-stackable / Pas empilable / Nicht stapelbar</i>													
	White MFC table Table blanche en mélamine <i>Couchtisch aus weißem Melamin</i>	TAV07	-22 PTS										
<i>Takes the place of one seat / Chaque tablette remplace une assise / Jede Tischplatte ersetzt einen Sitzplatz</i>													

ON REQUEST ONLY / SUR REQUETE / AUF ANFRAGE

	Fire retardant shell, 300-unit minimum order in one color Version non-feu, à partir de 300 pièces <i>Feuerfeste Ausführung, mindestens 300 Schalen pro Farbe</i>	IGNI	+52 PTS
	Powder coated frame in a special finish, 2-unit minimum order Cadre en coloris spéciaux, à partir de 2 pièces <i>Gestell: Sonderlackierung nach Kundenwunsch, ab 2 Stück</i>	VERN	+165 PTS
<i>Price on request for special varnish finishes / Pour vernis spécifiques, devis sur requête / Sonderlackfarben auf Anfrage</i>			

Clue 3-person polypropylene beam seat
Poutre Clue polypropylène, 3 places
Clue 3er Polypropylen

CLUE

FULL POLYPROPYLENE SHELL
 COQUE EN POLYPROPYLÈNE
 SCHALE AUS POLYPROPYLEN

Cod. OCLUE301

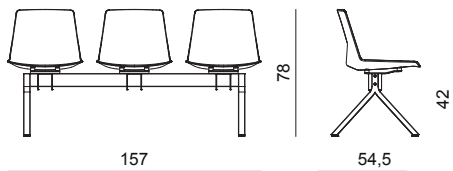

8mm polypropylene shell; 80×40×2mm beam made from powder coated steel tube; 400×300×2mm powder coated steel legs; polyethylene adjustable levelling feet.

Coque en polypropylène ép. 8mm; poutre en acier 80×40×2 verni à poudre époxy; piètement en acier 40×30×2 verni à poudre époxy; patins réglables en polyéthylène.

Schale aus Polypropylen, Stärke 8 mm; Stahlträger 80×40×2 epoxidpulverbeschichtet; Stahlbeine 40×30×2 epoxidpulverbeschichtet; verstellbare FüÙe aus Polyethylen.

3 box
 1 u. x box
 0,170 M³

KG
 24,50
 26,50

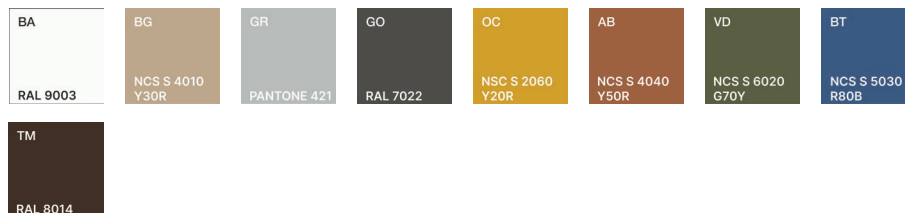

Depending on the surface the color may vary slightly from the reference (RAL / NCS) provided.
 En fonction de la surface, la couleur peut varier légèrement par rapport à la référence (RAL / NCS) fournie.
 Je nach Oberfläche kann die Farbe in Bezug auf die RAL/NCS Referenz abweichen.

BASE / BASE / GESTELL

	Powder coated frame and beam in silver Piètement verni alu; poutre en teinte Untergestell Metall Alu pulverbeschichtet. Traverse in gleicher Farbe	STR07VA	870 PTS
	Powder coated frame and beam in anthracite Piètement verni gris ombre; poutre en teinte Untergestell Metall Dunkelgrau pulverbeschichtet. Traverse in gleicher Farbe	STR07VO	870 PTS

ACCESSORIES / ACCESSOIRES / ZUBEHÖR

	B01/B03 fabric/faux leather upholstered small soft pad in the shown colors Coussin revêtu en tissu/textile enduit B01/B03 (dans les revêtements indiqués) Gepolstertes Kissen mit Stoff/Kunstleder Kat. B01/B03 bezogen (in den angegebenen Farben)	CU4B	+46 PTS										
<p>B01: 009 / 010 / 012 / 013 / 018 / 023 / 027 / 028 / 222 B03: 138 / 141 / 170 / 175 / 179 / 181 / 182 / 183</p> <p>B01 & B03 finishes which do not show are available on request, 12 unit minimum order: furter +17 pts upcharge / Les revêtements B01 et B03 non indiqués, sont disponibles sur requête, min. 12 pièces: +17 pts / Die Farben aus der Kategorie B01 bzw. B03, die hier nicht angegeben sind, sind auf Anfrage erhältlich, ab 12 Stück: + 17 Pkte</p>													
	Upholstered front of seat and back Rembourrage frontal fixe Feste Frontpolsterung	<table border="1"> <tr> <td>B01/B03 CU3B</td> <td>C01/C05 CU3C</td> <td>D02/D03 CU3D</td> <td>E01 CU3E</td> <td>P01 CU3P1</td> </tr> <tr> <td>+173 PTS</td> <td>+189 PTS</td> <td>+199 PTS</td> <td>+210 PTS</td> <td>+299 PTS</td> </tr> </table>	B01/B03 CU3B	C01/C05 CU3C	D02/D03 CU3D	E01 CU3E	P01 CU3P1	+173 PTS	+189 PTS	+199 PTS	+210 PTS	+299 PTS	
B01/B03 CU3B	C01/C05 CU3C	D02/D03 CU3D	E01 CU3E	P01 CU3P1									
+173 PTS	+189 PTS	+199 PTS	+210 PTS	+299 PTS									
Non-stackable / Pas empilable / Nicht stapelbar		Price refers to one single seat / Prix par chaise / Preis pro Sitz											
	Fixed front padding, upholstery on request Rembourrage frontal fixe, revêtement sur demande Vordere Polsterung fest, Überzug auf Anfrage	<table border="1"> <tr> <td>D04/D06 CU3D</td> <td>E02/E03/E04 CU3E</td> <td>I01/I02 CU3I</td> <td>M02/M03 CU3M</td> </tr> <tr> <td>+199 PTS</td> <td>+210 PTS</td> <td>+277 PTS</td> <td>+311 PTS</td> </tr> </table>	D04/D06 CU3D	E02/E03/E04 CU3E	I01/I02 CU3I	M02/M03 CU3M	+199 PTS	+210 PTS	+277 PTS	+311 PTS			
D04/D06 CU3D	E02/E03/E04 CU3E	I01/I02 CU3I	M02/M03 CU3M										
+199 PTS	+210 PTS	+277 PTS	+311 PTS										
Non-stackable / Pas empilable / Nicht stapelbar													
	White MFC table Table blanche en mélamine Couchtisch aus weißem Melamin	TAV07	-22 PTS										
Takes the place of one seat / Chaque tablette remplace une assise / Jede Tischplatte ersetzt einen Sitzplatz													

ON REQUEST ONLY / SUR REQUETE / AUF ANFRAGE

	Fire retardant shell, 300-unit minimum order in one color Version non-feu, à partir de 300 pièces Feuerfeste Ausführung, mindestens 300 Schalen pro Farbe	IGNI	+81 PTS
	Powder coated frame in a special finish, 2-unit minimum order Cadre en coloris spéciaux, à partir de 2 pièces Gestell: Sonderlackierung nach Kundenwunsch, ab 2 Stück	VERN	+165 PTS
Price on request for special varnish finishes / Pour vernis spécifiques, devis sur requête / Sonderlackfarben auf Anfrage			

Cod. OCLUE401

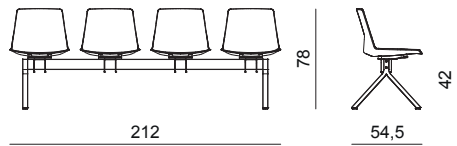

8mm polypropylene shell; 80×40×2mm beam made from powder coated steel tube; 400×300×2mm powder coated steel legs; polyethylene adjustable levelling feet.

Coque en polypropylène ép. 8mm; poutre en acier 80×40×2 verni à poudre époxy; piètement en acier 40×30×2 verni à poudre époxy; patins réglables en polyéthylène.

Schale aus Polypropylen, Stärke 8 mm; Stahlträger 80×40×2 epoxidpulverbeschichtet; Stahlbeine 40×30×2 epoxidpulverbeschichtet; verstellbare FüÙe aus Polyethylen.

4 box
1 u. x box
0,300 M³

31,00
34,00

BA RAL 9003	BG NCS S 4010 Y30R	GR PANTONE 421	GO RAL 7022	OC NCS S 2060 Y20R	AB NCS S 4040 Y50R	VD NCS S 6020 G70Y	BT NCS S 5030 R80B
TM RAL 8014							

Depending on the surface the color may vary slightly from the reference (RAL / NCS) provided.
En fonction de la surface, la couleur peut varier légèrement par rapport à la référence (RAL / NCS) fournie.
Je nach Oberfläche kann die Farbe in Bezug auf die RAL/NCS Referenz abweichen.

BASE / BASE / GESTELL

	Powder coated frame and beam in silver Piètement verni alu; poutre en teinte <i>Untergestell Metall Alu pulverbeschichtet. Traverse in gleicher Farbe</i>	STR07VA	1009 PTS
	Powder coated frame and beam in anthracite Piètement verni gris ombre; poutre en teinte <i>Untergestell Metall Dunkelgrau pulverbeschichtet. Traverse in gleicher Farbe</i>	STR07VO	1009 PTS

ACCESSORIES / ACCESSOIRES / ZUBEHÖR

	B01/B03 fabric/faux leather upholstered small soft pad in the shown colors Coussin revêtu en tissu/textile enduit B01/B03 (dans les revêtements indiqués) <i>Gepolstertes Kissen mit Stoff/Kunstleder Kat. B01/B03 bezogen (in den angegebenen Farben)</i>	CU4B	+46 PTS										
<p>B01: 009 / 010 / 012 / 013 / 018 / 023 / 027 / 028 / 222 B03: 138 / 141 / 170 / 175 / 179 / 181 / 182 / 183</p> <p>B01 & B03 finishes which do not show are available on request, 12 unit minimum order: further +17 pts upcharge / Les revêtements B01 et B03 non indiqués, sont disponibles sur requête, min. 12 pièces: +17 pts / Die Farben aus der Kategorie B01 bzw. B03, die hier nicht angegeben sind, sind auf Anfrage erhältlich, ab 12 Stück: + 17 Pkte</p>													
	Upholstered front of seat and back Rembourrage frontal fixe <i>Feste Frontpolsterung</i>	<table border="1"> <tr> <td>B01/B03 CU3B</td> <td>C01/C05 CU3C</td> <td>D02/D03 CU3D</td> <td>E01 CU3E</td> <td>P01 CU3P1</td> </tr> <tr> <td>+173 PTS</td> <td>+189 PTS</td> <td>+199 PTS</td> <td>+210 PTS</td> <td>+299 PTS</td> </tr> </table>	B01/B03 CU3B	C01/C05 CU3C	D02/D03 CU3D	E01 CU3E	P01 CU3P1	+173 PTS	+189 PTS	+199 PTS	+210 PTS	+299 PTS	
B01/B03 CU3B	C01/C05 CU3C	D02/D03 CU3D	E01 CU3E	P01 CU3P1									
+173 PTS	+189 PTS	+199 PTS	+210 PTS	+299 PTS									
<i>Non-stackable / Pas empilable / Nicht stapelbar</i>		<i>Price refers to one single seat / Prix par chaise / Preis pro Sitz</i>											
	Fixed front padding, upholstery on request Rembourrage frontal fixe, revêtement sur demande <i>Vordere Polsterung fest, Überzug auf Anfrage</i>	<table border="1"> <tr> <td>D04/D06 CU3D</td> <td>E02/E03/E04 CU3E</td> <td>I01/I02 CU3I</td> <td>M02/M03 CU3M</td> </tr> <tr> <td>+199 PTS</td> <td>+210 PTS</td> <td>+277 PTS</td> <td>+311 PTS</td> </tr> </table>	D04/D06 CU3D	E02/E03/E04 CU3E	I01/I02 CU3I	M02/M03 CU3M	+199 PTS	+210 PTS	+277 PTS	+311 PTS			
D04/D06 CU3D	E02/E03/E04 CU3E	I01/I02 CU3I	M02/M03 CU3M										
+199 PTS	+210 PTS	+277 PTS	+311 PTS										
<i>Non-stackable / Pas empilable / Nicht stapelbar</i>													
	White MFC table Table blanche en mélamine <i>Couchtisch aus weißem Melamin</i>	TAV07	-22 PTS										
<i>Takes the place of one seat / Chaque tablette remplace une assise / Jede Tischplatte ersetzt einen Sitzplatz</i>													

ON REQUEST ONLY / SUR REQUETE / AUF ANFRAGE

	Fire retardant shell, 300-unit minimum order in one color Version non-feu, à partir de 300 pièces <i>Feuerfeste Ausführung, mindestens 300 Schalen pro Farbe</i>	IGNI	+107 PTS
	Powder coated frame in a special finish, 2-unit minimum order Cadre en coloris spéciaux, à partir de 2 pièces <i>Gestell: Sonderlackierung nach Kundenwunsch, ab 2 Stück</i>	VERN	+165 PTS
<i>Price on request for special varnish finishes / Pour vernis spécifiques, devis sur requête / Sonderlackfarben auf Anfrage</i>			

Clue fully upholstered chair, 4 metal legs

Chaise tapissée Clue, 4 pieds métal

Clue Stuhl gepolstert, 4-Fuß Metallgestell

CLUE

FULLY UPHOLSTERED SHELL
COQUE TAPISSÉE
GEPOLSTERTE SCHALE

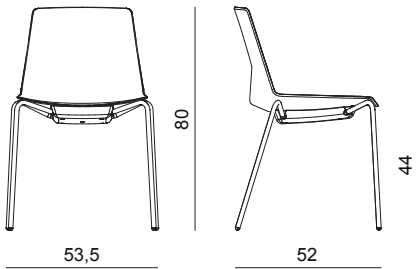

Cod. OCLUEV21

8mm polypropylene shell; injection moulded polyurethane foam; frame made from Ø16mm highly resilient steel tube; polyethylene glides; polypropylene cover to the underside of the seat.

Coque interne en polypropylène ép. 8 mm; rembourrage en polyuréthane expansée à haute élasticité; cadre en tube d'acier à haute résistance Ø16mm; patins en polyéthylène; sous-assise en polypropylène.

Innenschale aus Polypropylen, Stärke 8 mm; Polsterung aus hochelastischem Polyurethanschaum; Gestell aus hochfestem Stahlrohr, Ø16 mm; Füße aus Polyethylen; Unterer Sitzteil aus Polypropylen.

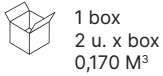

1 box
2 u. x box
0,170 M³



11,00
12,50





UPHOLSTERY / REVETEMENT / BEZUG

B01/B03	C01/C05	D02/D03	E01	P01
420 PTS	459 PTS	477 PTS	520 PTS	675 PTS



UPHOLSTERY ON REQUEST / REVETEMENT SUR REQUETE / ÜBERZUG AUF ANFRAGE

D04/D06	E02/E03/E04	I01/I02	M02/M03
477 PTS	520 PTS	653 PTS	722 PTS

FRAME / CADRE / GESTELL

	Chrome frame Cadre chromé Verchromtes Gestell	FSC18	=
	Powder coated frame in silver Cadre verni alu Gestell Aluminium lackiert	FSG18	=
	Powder coated frame in white Cadre verni blanc Gestell Weiß lackiert	FSB18	=
	Powder coated frame in anthracite Cadre verni gris ombre Gestell Dunkelgrau lackiert	FST18	=

ACCESSORIES / ACCESSOIRES / ZUBEHÖR

	Articulating adjustable feet complete with felt pads Patins feutrés dénoués Gelenkfüße mit Filzgleiter	PD001	+20 PTS
	Set of silent anti-scratch felt pads and glides Kit de patins de feutres et patins anti-rayures et anti-bruit Kit kratzfesten und geräuschkämpfenden Filzgleiter.	ACC12	+17 PTS

ON REQUEST ONLY / SUR REQUETE / AUF ANFRAGE



	Gold powder coated frame Structure vernie or Gestell Gold lackiert	OR	+131 PTS
--	---	-----------	----------

CLUE

FULLY UPHOLSTERED SHELL
COQUE TAPISSÉE
GEPOLSTERTE SCHALE

Clue fully upholstered chair, 4 metal legs
Chaise tapissée Clue, 4 pieds métal
Clue Stuhl gepolstert, 4-Fuß Metallgestell

ON REQUEST ONLY / SUR REQUÊTE / AUF ANFRAGE

	Bronze powder coated frame Structure vernie bronze Gestell Bronze lackiert	BR	+131 PTS
	Corten powder coated frame Structure vernie corten Gestell Corten lackiert	CO	+131 PTS
	Powder coated frame in a special finish, 6-unit minimum order Cadre en coloris spéciaux, à partir de 6 pièces Gestell: Sonderlackierung nach Kundenwunsch, ab 6 Stück <small>Price on request for special varnish finishes / Pour vernis spécifiques, devis sur requête / Sonderlackfarben auf Anfrage</small>	VERN	+83 PTS

Clue fully upholstered chair, 4 metal legs with integral arms

Chaise tapissée Clue, 4 pieds métal avec accoudoirs

Clue Stuhl gepolstert, 4-Fuß Metallgestell mit Armlehnen

CLUE

FULLY UPHOLSTERED SHELL
COQUE TAPISSÉE
GEPOLSTERTE SCHALE

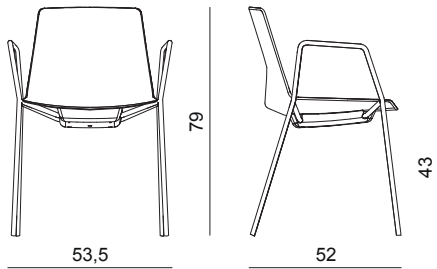

Cod. OCLUEV26

8mm polypropylene shell; injection moulded polyurethane foam; frame made from Ø16mm highly resilient steel tube with integral arms; polyethylene glides; polypropylene cover to the underside of the seat includes rubber spacers for stacking.

Coque en polypropylène ép.8 mm; rembourrage en polyuréthane expansée à haute élasticité; plaque en nylon et acier; piètement en tube d'acier Ø16mm avec accoudoirs; patins en polyéthylène.

Innenschale aus 8 mm starkem Polypropylen; Polsterung aus hochelastischem Polyurethanschaum; Gestell aus 16 mm hochfestem Stahlrohr mit Armlehnen; Füße aus Polyethylen.

1 box
2 u. x box
0,280 M³

12,00
14,50

UPHOLSTERY / REVETEMENT / BEZUG

B01/B03	C01/C05	D02/D03	E01	P01
513 PTS	552 PTS	571 PTS	615 PTS	770 PTS

UPHOLSTERY ON REQUEST / REVETEMENT SUR REQUETE / ÜBERZUG AUF ANFRAGE

D04/D06	E02/E03/E04	I01/I02	M02/M03
571 PTS	615 PTS	747 PTS	815 PTS

FRAME / CADRE / GESTELL

	Chrome frame with integral arms Cadre avec accoudoirs chromés Verchromtes Gestell mit Armlehnen	FSC19	=
	Frame with integral arms, powder coated in silver Cadre avec accoudoirs vernis en alu Gestell mit Armlehnen aus lackiertem Aluminium	FSG19	=
	Frame with integral arms, powder coated in white Cadre avec accoudoirs vernis en blanc Gestell mit weiß lackierten Armlehnen	FSB19	=
	Frame with integral arms, powder coated in anthracite Cadre avec accoudoirs vernis en gris ombre Gestell mit Armlehnen Dunkelgrau lackiert	FST19	=



ACCESSORIES / ACCESSOIRES / ZUBEHÖR

	Articulating adjustable feet complete with felt pads Patins feutrés dénoués Gelenkfüße mit Filzgleiter	PD001	+20 PTS
	Set of silent anti-scratch felt pads and glides Kit de patins de feutres et patins anti-rayures et anti-bruit Kit kratzfesten und geräuschkämpfenden Filzgleiter.	ACC12	+17 PTS

ON REQUEST ONLY / SUR REQUETE / AUF ANFRAGE

	Gold powder coated frame Structure vernie or Gestell Gold lackiert	OR	+131 PTS
--	---	-----------	----------

ON REQUEST ONLY / SUR REQUÊTE / AUF ANFRAGE

	<p>Bronze powder coated frame Structure vernie bronze Gestell Bronze lackiert</p>	BR	+131 PTS
	<p>Corten powder coated frame Structure vernie corten Gestell Corten lackiert</p>	CO	+131 PTS
	<p>Powder coated frame in a special finish, 6-unit minimum order Cadre en coloris spéciaux, à partir de 6 pièces Gestell: Sonderlackierung nach Kundenwunsch, ab 6 Stück <small>Price on request for special varnish finishes / Pour vernis spécifiques, devis sur requête / Sonderlackfarben auf Anfrage</small></p>	VERN	+83 PTS

Clue fully upholstered chair, sled metal base

Chaise tapissée Clue, luge métal

Clue Stuhl gepolstert, Metallkufengestell

CLUE

FULLY UPHOLSTERED SHELL
COQUE TAPISSÉE
GEPOLSTERTE SCHALE

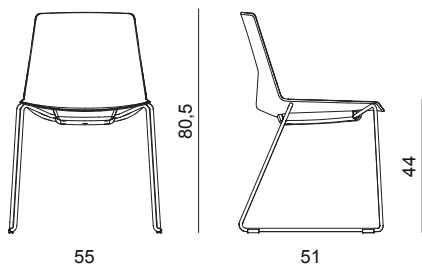

Cod. OCLUEV22

8mm polypropylene shell; injection moulded polyurethane foam; frame made from Ø12mm steel tube; polyethylene glides; polypropylene cover to the underside of the seat includes rubber spacers for stacking.

Coque interne en polypropylène ép. 8 mm; rembourrage en polyuréthane expansée à haute élasticité; cadre en acier Ø12mm; patins en polyéthylène; sous-assise en polypropylène.

Innenschale aus 8 mm starkem Polypropylen; Polsterung aus hochelastischem Polyurethanschaum; Untergestell aus Stahlstange Ø12 mm; Füße aus Polyethylen; Unterer Sitzteil aus Polypropylen.

CATAS UNI EN 16139 Level 1, UNI EN 1022, UNI EN 1728

1 box
2 u. x box
0,170 M³

15,00
16,50

UPHOLSTERY / REVETEMENT / BEZUG

B01/B03	C01/C05	D02/D03	E01	P01
448 PTS	488 PTS	506 PTS	549 PTS	703 PTS

UPHOLSTERY ON REQUEST / REVETEMENT SUR REQUETE / ÜBERZUG AUF ANFRAGE

D04/D06	E02/E03/E04	I01/I02	M02/M03
506 PTS	549 PTS	682 PTS	750 PTS

FRAME / CADRE / GESTELL

	Chrome frame Cadre chromé Verchromtes Gestell	FSC20	=
	Powder coated frame in silver Cadre verni alu Gestell Aluminium lackiert	FSG20	=
	Powder coated frame in white Cadre verni blanc Gestell Weiß lackiert	FSB20	=
	Powder coated frame in anthracite Cadre verni gris ombre Gestell Dunkelgrau lackiert	FST20	=

ON REQUEST ONLY / SUR REQUETE / AUF ANFRAGE

	Gold powder coated frame Structure vernie or Gestell Gold lackiert	OR	+131 PTS
	Bronze powder coated frame Structure vernie bronze Gestell Bronze lackiert	BR	+131 PTS
	Corten powder coated frame Structure vernie corten Gestell Corten lackiert	CO	+131 PTS
	Powder coated frame in a special finish, 6-unit minimum order Cadre en coloris spéciaux, à partir de 6 pièces Gestell: Sonderlackierung nach Kundenwunsch, ab 6 Stück Price on request for special varnish finishes / Pour vernis spécifiques, devis sur requête / Sonderlackfarben auf Anfrage	VERN	+83 PTS

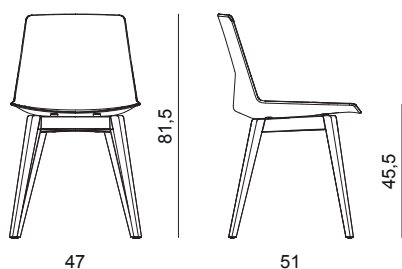

Cod. OCLUEV23

8mm polypropylene shell; injection moulded polyurethane foam; base made from varnished solid ash wood; nylon glides.

Coque interne en polypropylène ép. 8 mm; rembourrage en polyuréthane expansée à haute élasticité; cadre en frêne massif verni; patins en nylon.

Innenschale aus 8 mm starkem Polypropylen; Polsterung aus hochelastischem Polyurethanschaum; Untergestell aus lackierter massiver Esche; Füße aus Nylon.

CATAS UNI EN 16139, UNI EN 1022, UNI EN 1728



2 box
2 u. x box
0,240 M³



11,00
13,00

UPHOLSTERY / REVETEMENT / BEZUG

B01/B03	C01/C05	D02/D03	E01	P01
562 PTS	601 PTS	619 PTS	663 PTS	816 PTS

UPHOLSTERY ON REQUEST / REVETEMENT SUR REQUETE / ÜBERZUG AUF ANFRAGE

D04/D06	E02/E03/E04	I01/I02	M02/M03
619 PTS	663 PTS	795 PTS	864 PTS

FRAME / CADRE / GESTELL

	Oak varnished solid ash wood Frêne massif verni chêne Esche massiv Eiche hell lackiert	FSFK2	=
	Walnut varnished solid ash wood Frêne massif verni noyer canaletto Esche massiv Nussbaum Kanaletto lackiert	FSFN2	=

ACCESSORIES / ACCESSOIRES / ZUBEHÖR

	Nylon feet supplied with felt pads for wooden flooring Patins de feutres en nylon Nylonfüße mit Filzgleiter	ACC10	+8 PTS
---	--	-------	--------

ON REQUEST ONLY / SUR REQUETE / AUF ANFRAGE



Powder coated frame in a special finish, 10-unit minimum order
Cadre en coloris spéciaux, à partir de 10 pièces
Gestell: Sonderlackierung nach Kundenwunsch, ab 10 Stück

Price on request for special varnish finishes / Pour vernis spécifiques, devis sur requête / Sonderlackfarben auf Anfrage

VERN +41 PTS

Clue fully upholstered chair, spider metal frame

Chaise tapissée Clue, piètement étoile pivotant métal

Clue Stuhl gepolstert, 4-Fuß Designgestell aus Stahl

FULLY UPHOLSTERED SHELL
COQUE TAPISSÉE
GEPOLSTERTE SCHALE

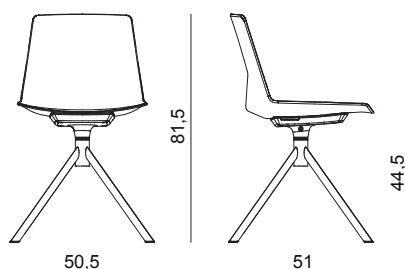

Cod. OCLUEV24

8mm polypropylene shell; injection moulded polyurethane foam; gas lift; steel reinforced nylon plate; spider base made from 2mm

30×15mm elliptical steel tube; polypropylene glides with felt pads.

Coque en polypropylène ép.8 mm; rembourrage en polyuréthane expansée à haute élasticité; plaque en nylon et acier; piètement en tube elliptique d'acier 30×15 ép.2 mm; patins feutrés en polypropylène.

Innenschale aus 8 mm starkem Polypropylen; Polsterung aus hochelastischem Polyurethanschaum; Platte aus Nylon mit Stahl verstärkt; Beine aus 30 × 15 mm starkem elliptischem Stahlrohr; Füße aus Polypropylen mit Filzgleitern.

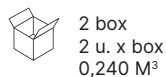

2 box
2 u. x box
0,240 M³



13,00
15,00

UPHOLSTERY / REVETEMENT / BEZUG

B01/B03	C01/C05	D02/D03	E01	P01
568 PTS	605 PTS	623 PTS	668 PTS	823 PTS

UPHOLSTERY ON REQUEST / REVETEMENT SUR REQUETE / ÜBERZUG AUF ANFRAGE

D04/D06	E02/E03/E04	I01/I02	M02/M03
623 PTS	668 PTS	800 PTS	869 PTS

BASE / BASE / GESTELL

	Chromed steel spider base, plate in silver Piètement en acier chromé, plaque en alu <i>Verchromtes Stahlbockgestell, alufarbene Platte</i>	BAF01	=
	Steel spider base, powder coated in silver, matching plate Piètement en acier verni alu, plaque en teinte <i>Stahlbockgestell aus Stahl lackiertem Aluminium, Platte in gleicher Farbe</i>	BAF02	=
	Steel spider base, powder coated in white, matching plate Piètement en acier verni blanc, plaque en teinte <i>Stahlbockgestell aus weiß lackiertem Stahl, Platte in gleicher Farbe</i>	BAF03	=
	Steel spider base, powder coated in anthracite, matching plate Piètement en acier verni gris ombre, plaque en teinte <i>Stahlbockgestell aus stahlgrau lackiertem Schatten, Platte in gleicher Farbe</i>	BAF04	=

ACCESSORIES / ACCESSOIRES / ZUBEHÖR

	Chrome steel armrest Accoudoir en acier chromé <i>Verchromte Armlehne aus Stahl</i>	BRF15CR	+134 PTS
	Silver painted steel armrest Accoudoir en acier verni alu <i>Armlehne aus Stahl Aluminium lackiert</i>	BRF15VA	+134 PTS
	White painted steel armrest Accoudoir en acier verni blanc <i>Armlehne aus Stahl Weiß lackiert</i>	BRF15VB	+134 PTS
	Anthracite painted steel armrest Accoudoir en acier verni gris ombre <i>Armlehne aus Stahl Dunkelgrau lackiert</i>	BRF15VO	+134 PTS
	Die-cast brushed aluminium armrest Accoudoir en alu brossé <i>Armlehne aus gebürstetem Aluminiumdruckguss</i>	BRF16	+156 PTS

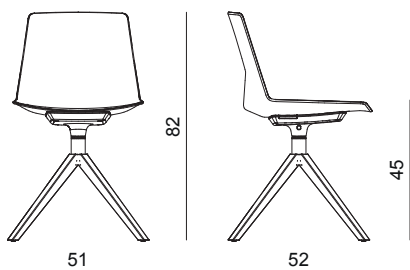

Cod. OCLUEV25

8mm polypropylene shell; injection moulded polyurethane foam; gas lift; steel reinforced nylon plate; powder coated steel swivel column; spider base made from varnished solid ash wood; nylon glides.

Coque en polypropylène ép.8 mm; rembourrage en polyuréthane expansée à haute élasticité; plaque en nylon et acier; rotor en acier verni; piètement en frêne massif verni; patins en nylon.

Innenschale aus 8 mm starkem Polypropylen; Polsterung aus hochelastischem Polyurethanschaum; Platte aus Nylon mit Stahl verstärkt; Drehplatte aus lackiertem Stahl; Beine aus lackierter massiver Esche; Füße aus Nylon.

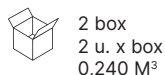

2 box
2 u. x box
0,240 M³



13,00
15,00

UPHOLSTERY / REVETEMENT / BEZUG

B01/B03	C01/C05	D02/D03	E01	P01
789 PTS	829 PTS	847 PTS	889 PTS	1044 PTS

UPHOLSTERY ON REQUEST / REVETEMENT SUR REQUETE / ÜBERZUG AUF ANFRAGE

D04/D06	E02/E03/E04	I01/I02	M02/M03
847 PTS	889 PTS	1022 PTS	1091 PTS

BASE / BASE / GESTELL

	Oak varnished solid ash wood legs, anthracite painted metal column with matching box under the seat Piètement en frêne verni chêne, rotor verni blanc avec plaque en teinte Gestell aus Eiche hell-lackierter Esche, Weiß lackierte Drehplatte Gestell Esche Eiche hell lackiert, Weiß lackierte Drehplatte	BAL05	=
	Oak varnished solid ash wood legs, white painted metal column with matching box under the seat Piètement en frêne verni chêne, rotor verni gris ombre avec plaque en teinte Gestell aus Eiche hell-lackierter Esche, Dunkelgrau lackierte Drehplatte Gestell Esche Eiche hell lackiert, Dunkelgrau lackierte Drehplatte	BAL06	=
	Walnut varnished solid ash wood legs, anthracite painted metal column with matching box under the seat Piètement en frêne verni noyer canaletto, rotor verni blanc avec plaque en teinte Gestell Esche Nußbaum Kanaletto lackiert, Weiß lackierte Drehplatte	BAL03	=
	Walnut varnished solid ash wood legs, white painted metal column with matching box under the seat Piètement en frêne verni noyer canaletto, rotor verni gris ombre avec plaque en teinte Gestell Esche Nußbaum Kanaletto lackiert, Dunkelgrau lackierte Drehplatte	BAL04	=

ACCESSORIES / ACCESSOIRES / ZUBEHÖR



	Chrome steel armrest Accoudoir en acier chromé Verchromte Armlehne aus Stahl	BRF15CR	+134 PTS
	Silver painted steel armrest Accoudoir en acier verni alu Armlehne aus Stahl Aluminium lackiert	BRF15VA	+134 PTS
	White painted steel armrest Accoudoir en acier verni blanc Armlehne aus Stahl Weiß lackiert	BRF15VB	+134 PTS
	Anthracite painted steel armrest Accoudoir en acier verni gris ombre Armlehne aus Stahl Dunkelgrau lackiert	BRF15VO	+134 PTS

Clue fully upholstered chair, spider wooden frame
Chaise tapissée Clue, piètement étoile pivotant bois
Clue Stuhl gepolstert, 4-Fuß Designgestell aus Holz

CLUE

FULLY UPHOLSTERED SHELL
COQUE TAPISSÉE
GEPOLSTERTE SCHALE

ACCESSORIES / ACCESSOIRES / ZUBEHÖR

	Die-cast brushed aluminium armrest Accoudoir en alu brossé <i>Armlehne aus gebürstetem Aluminiumdruckguss</i>	BRF16	+156 PTS
	Nylon feet supplied with felt pads for wooden flooring Patins de feutres en nylon <i>Nylonfüße mit Filzgleiter</i>	ACC10	+8 PTS

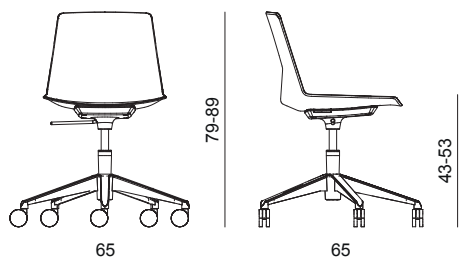

Cod. OCLUEA21

8mm polypropylene shell; injection moulded polyurethane foam; gas lift; steel reinforced nylon plate.
Coque en polypropylène ép. 8 mm; rembourrage en polyuréthane expansée à haute élasticité; plaque en nylon et acier; vérin à gaz lift.
Innenschale aus 8 mm starkem Polypropylen; Polsterung aus hochelastischem Polyurethanschaum; verstärkte Nylonplatte aus Stahl; Gasfeder.

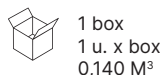

1 box
1 u. x box
0,140 M³



8,50
10,00

UPHOLSTERY / REVETEMENT / BEZUG

B01/B03	C01/C05	D02/D03	E01	P01
562 PTS	601 PTS	619 PTS	663 PTS	816 PTS

UPHOLSTERY ON REQUEST / REVETEMENT SUR REQUETE / ÜBERZUG AUF ANFRAGE

D04/D06	E02/E03/E04	I01/I02	M02/M03
619 PTS	663 PTS	795 PTS	864 PTS

BASE / BASE / GESTELL

	Powder coated aluminium 5-star base, silver finish Piètement 5 branches en alu avec plaque en teinte 5-Sternfußkreuz aus Aluminium, Ausführung Silber pulverbeschichtet	BAA10	=
	Powder coated aluminium 5-star base, white finish Piètement 5 branches en alu verni blanc avec plaque en teinte 5-Sternfußkreuz aus Aluminium, Ausführung Weiß pulverbeschichtet	BAA11	=
	Powder coated aluminium 5-star base, anthracite finish Piètement 5 branches en alu verni gris ombre avec plaque en teinte 5-Sternfußkreuz aus Aluminium, Ausführung Dunkelgrau pulverbeschichtet	BAA15	=









ACCESSORIES / ACCESSOIRES / ZUBEHÖR

	Chrome steel armrest Accoudoir en acier chromé Verchromte Armlehne aus Stahl	BRF15CR	+134 PTS
	Silver painted steel armrest Accoudoir en acier verni alu Armlehne aus Stahl Aluminium lackiert	BRF15VA	+134 PTS
	White painted steel armrest Accoudoir en acier verni blanc Armlehne aus Stahl Weiß lackiert	BRF15VB	+134 PTS
	Anthracite painted steel armrest Accoudoir en acier verni gris ombre Armlehne aus Stahl Dunkelgrau lackiert	BRF15VO	+134 PTS
	Die-cast brushed aluminium armrest Accoudoir en alu brossé Armlehne aus gebürstetem Aluminiumdruckguss	BRF16	+156 PTS

Clue fully upholstered chair, 5-star swivel frame on castors
 Chaise tapissée Clue, base pivotante 5 branches sur roulettes
 Clue Stuhl gepolstert, 5 Sternfuß auf Rollen

CLUE

FULLY UPHOLSTERED SHELL
 COQUE TAPISSÉE
 GEPOLSTERTE SCHALE

ACCESSORIES / ACCESSOIRES / ZUBEHÖR			
	65mmØ twin wheel brake unloaded hard black castors Roulettes standard Ø65mm- autofreinées Standard-Rollen Ø65mm - selbstbremsend	RG06	=
	65mmØ twin wheel brake unloaded soft black castors Roulettes sol dur Ø65mm - autofreinées Gummirollen Ø65mm - selbstbremsend	RG02	+25 PTS
	60mmØ twin wheel unbraked white soft castors Roulettes sol dur blanches Ø60mm - libres Weiße Gummirollen Ø60mm	RG07	+33 PTS
	60mmØ twin wheel unbraked silver soft castors Roulettes sol dur alu Ø60mm - libres Aluminium-Gummirollen Ø60mm	RG08	+33 PTS
	65mmØ twin wheel brake unloaded ring-shaped white soft castors Roulettes "ring" sol dur blanches Ø65mm - autofreinées Weiß gummierte "Ring"-Rollen Ø65mm - selbstbremsend	RG09	+51 PTS
	65mmØ twin wheel brake unloaded ring-shaped soft silver castors Roulettes "ring" sol dur alu Ø65mm - autofreinées Gummierte Aluminium "Ring"-Rollen Ø65mm - selbstbremsend	RG10	+51 PTS
	65mmØ twin wheel brake unloaded ring-shaped soft black castors Roulettes "ring" sol dur noires Ø65mm - autofreinées Schwarz gummierte "Ring"-Rollen Ø65mm - selbstbremsend	RG12	+51 PTS
	65mmØ twin wheel brake unloaded ring-shaped soft black/chrome castors - chrome metal hood Roulettes "ring" sol dur chromées/noires Ø65mm - autofreinées Verchromte/schwarze Gummirollen Ø65mm - selbstbremsend	RG11	+56 PTS
	White HPL 360° swivel tablet; for left and right hand users. Tablette orbitale ergonomique en HPL en blanc Ergonomischer Schreibtisler in weißem HPL	TAV14	+191 PTS

CATAS UNI EN 16139 Level 2 Extreme use

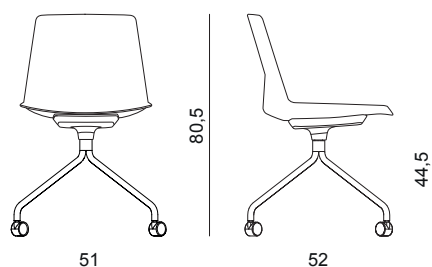

Cod. OCLUEA22

8mm polypropylene shell; injection moulded polyurethane foam; steel reinforced nylon plate; frame made from Ø22mm chromed or powder coated steel tube.

Coque en polypropylène ép. 8 mm; rembourrage en polyuréthane expansée à haute élasticité; plaque en nylon et acier; cadre en tube d'acier Ø22 chromé ou verni.

Innenschale aus 8 mm starkem Polypropylen; Polsterung aus hochelastischem Polyurethanschaum; Platte aus Nylon mit Stahl verstärkt; Gestell aus Ø22 verchromtem oder lackiertem Stahlrohr.

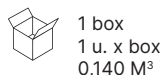

1 box
1 u. x box
0,140 M³



7,00
9,00

UPHOLSTERY / REVETEMENT / BEZUG

B01/B03	C01/C05	D02/D03	E01	P01
562 PTS	601 PTS	619 PTS	663 PTS	816 PTS

UPHOLSTERY ON REQUEST / REVETEMENT SUR REQUETE / ÜBERZUG AUF ANFRAGE

D04/D06	E02/E03/E04	I01/I02	M02/M03
619 PTS	663 PTS	795 PTS	864 PTS

BASE / BASE / GESTELL

	4-star base on castors, chromed, plate in silver Base 4 roulettes chromée avec plaque en alu 4-Sternfußkreuz verchromt mit Aluminium Unterplatte	BAF05	=
	4-star base on castors, powder coated in silver with matching plate Base 4 roulettes vernie alu avec plaque en teinte 4-Sternfußkreuz Alu pulverbeschichtet mit Unterplatte in gleicher Farbe	BAF06	=
	4-star base on castors, powder coated in white with matching plate Base 4 roulettes vernie en blanc avec plaque en teinte 4-Sternfußkreuz Weiß pulverbeschichtet mit Unterplatte in gleicher Farbe	BAF07	=
	4-star base on castors, powder coated in anthracite with matching plate Base 4 roulettes vernie en gris ombre avec plaque en teinte 4-Sternfußkreuz Dunkelgrau pulverbeschichtet mit Unterplatte in gleicher Farbe	BAF08	=









ACCESSORIES / ACCESSOIRES / ZUBEHÖR

	Chrome steel armrest Accoudoir en acier chromé Verchromte Armlehne aus Stahl	BRF15CR	+134 PTS
	Silver painted steel armrest Accoudoir en acier verni alu Armlehne aus Stahl Aluminium lackiert	BRF15VA	+134 PTS
	White painted steel armrest Accoudoir en acier verni blanc Armlehne aus Stahl Weiß lackiert	BRF15VB	+134 PTS
	Anthracite painted steel armrest Accoudoir en acier verni gris ombre Armlehne aus Stahl Dunkelgrau lackiert	BRF15VO	+134 PTS

Clue fully upholstered chair, 4-star base on castors
 Chaise tapissée Clue, piétement 4 roulettes
 Clue Stuhl gepolstert, 4 Sternfuß auf Rollen

CLUE

FULLY UPHOLSTERED SHELL
 COQUE TAPISSÉE
 GEPOLSTERTE SCHALE

ACCESSORIES / ACCESSOIRES / ZUBEHÖR			
	Die-cast brushed aluminium armrest Accoudoir en alu brossé Armlehne aus gebürstetem Aluminiumdruckguss	BRF16	+156 PTS
	65mmØ twin wheel brake unloaded hard black castors Roulettes standard Ø65mm- autofreinées Standard-Rollen Ø65mm - selbstbremsend	RG06	=
	65mmØ twin wheel brake unloaded soft black castors Roulettes sol dur Ø65mm - autofreinées Gummirollen Ø65mm - selbstbremsend	RG02	+25 PTS
	60mmØ twin wheel unbraked white soft castors Roulettes sol dur blanches Ø60mm - libres Weiße Gummirollen Ø60mm	RG07	+33 PTS
	60mmØ twin wheel unbraked silver soft castors Roulettes sol dur alu Ø60mm - libres Aluminium-Gummirollen Ø60mm	RG08	+33 PTS
	65mmØ twin wheel brake unloaded ring-shaped white soft castors Roulettes "ring" sol dur blanches Ø65mm - autofreinées Weiß gummierte "Ring"-Rollen Ø65mm - selbstbremsend	RG09	+51 PTS
	65mmØ twin wheel brake unloaded ring-shaped soft silver castors Roulettes "ring" sol dur alu Ø65mm - autofreinées Gummierte Aluminium "Ring"-Rollen Ø65mm - selbstbremsend	RG10	+51 PTS
	65mmØ twin wheel brake unloaded ring-shaped soft black castors Roulettes "ring" sol dur noires Ø65mm - autofreinées Schwarz gummierte "Ring"-Rollen Ø65mm - selbstbremsend	RG12	+51 PTS
	65mmØ twin wheel brake unloaded ring-shaped soft black/chrome castors - chrome metal hood Roulettes "ring" sol dur chromées/noires Ø65mm - autofreinées Verchromte/schwarze Gummirollen Ø65mm - selbstbremsend	RG11	+56 PTS

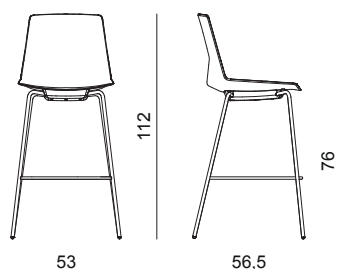

Cod. OCLUES21

8mm polypropylene shell; injection moulded polyurethane foam; frame made from Ø16mm highly resilient chromed steel tube; polyethylene glides; polypropylene cover to the underside of the seat.

Coque interne en polypropylène ép. 8 mm; rembourrage en polyuréthane expansée à haute élasticité; cadre en tube d'acier à haute résistance Ø16mm chromé; patins en polyéthylène; sous-assise en polypropylène.

Innenschale aus 8 mm starkem Polypropylen; Polsterung aus hochelastischem Polyurethanschaum; Gestell aus hochfestem verchromtem Stahlrohr mit 16 mm Durchmesser; Füße aus Polyethylen; unterer Sitz aus Polypropylen.



1 box
1 u. x box
0,330 M³



8,00
9,50

UPHOLSTERY / REVETEMENT / BEZUG

B01/B03	C01/C05	D02/D03	E01	P01
523 PTS	562 PTS	579 PTS	623 PTS	777 PTS

UPHOLSTERY ON REQUEST / REVETEMENT SUR REQUETE / ÜBERZUG AUF ANFRAGE

D04/D06	E02/E03/E04	I01/I02	M02/M03
579 PTS	623 PTS	756 PTS	825 PTS

FRAME / CADRE / GESTELL



Chrome frame
Cadre chromé
Verchromtes Gestell

FSC21

=

ACCESSORIES / ACCESSOIRES / ZUBEHÖR



Articulating adjustable feet complete with felt pads
Patins feutrés dénoués
Gelenkfüße mit Filzgleiter

PD001

+20 PTS



Set of silent anti-scratch felt pads and glides
Kit de patins de feutres et patins anti-rayures et anti-bruit
Kit kratzfesten und geräuschkämpfenden Filzgleiter.

ACC12

+17 PTS

ON REQUEST ONLY / SUR REQUETE / AUF ANFRAGE



Powder coated frame in a special finish, 2-unit minimum order
Cadre en coloris spéciaux, à partir de 2 pièces
Gestell: Sonderlackierung nach Kundenwunsch, ab 2 Stück

VERN

+83 PTS

Price on request for special varnish finishes / Pour vernis spécifiques, devis sur requête / Sonderlackfarben auf Anfrage

Clue fully upholstered stool, height adjustable swivel base

Tabouret Clue tapissé, base pivotante et vérin

Barhocker Clue gepolstert, dreh- und höhenverstellbar

CLUE

FULLY UPHOLSTERED SHELL
COQUE TAPISSÉE
GEPOLSTERTE SCHALE

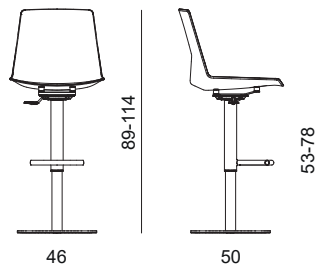

Cod. OCLUES23

8mm polypropylene shell; injection moulded polyurethane foam; steel plate; gas lift; weighted base covered with chrome steel sheet metal with height adjustable footrest.

Coque interne en polypropylène ép. 8 mm; rembourrage en polyuréthane expansée à haute élasticité; plaque en acier; vérin à gaz lift; piètement avec vérin recouvert en tôle d'acier chromé avec appuie-pieds à élévation.

Innenschale aus 8 mm starkem Polypropylen; Polsterung aus hochelastischem Polyurethanschaum; Sitzteller aus Stahl; Gasfeder; Gestell mit Ballast verchromtes Stahlblech mit Fußstütze höhenverstellbar.



1 box
1 u. x box
0,350 M³



19,00
20,50

UPHOLSTERY / REVETEMENT / BEZUG

B01/B03	C01/C05	D02/D03	E01	P01
759 PTS	799 PTS	816 PTS	861 PTS	1014 PTS

UPHOLSTERY ON REQUEST / REVETEMENT SUR REQUETE / ÜBERZUG AUF ANFRAGE

D04/D06	E02/E03/E04	I01/I02	M02/M03
816 PTS	861 PTS	992 PTS	1061 PTS

BASE / BASE / GESTELL



Chrome weighted flat base with height adjustable footrest
Piètement chromé avec appuie-pieds et lift
Gestell verchromt, inkl. Fußstütze höhenverstellbar

BAC03

=

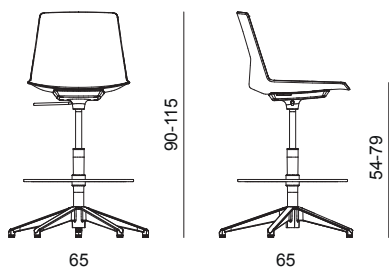

Cod. OCLUES24

8mm polypropylene shell; injection moulded polyurethane foam; gas lift; steel reinforced nylon plate; height adjustable footrest.

Coque interne en polypropylène ép. 8 mm; rembourrage en polyuréthane expansée à haute élasticité; vérin à gaz lift; plaque en nylon et acier; appuie-pieds réglable en hauteur.

Innenschale aus 8 mm starkem Polypropylen; Polsterung aus hochelastischem Polyurethanschaum; Gasfeder; verstärkte Nylonplatte aus Stahl; Fußstütze höhenverstellbar.

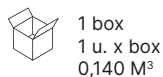

1 box
1 u. x box
0,140 M³



9,00
10,50

UPHOLSTERY / REVETEMENT / BEZUG

B01/B03	C01/C05	D02/D03	E01	P01
632 PTS	670 PTS	690 PTS	732 PTS	886 PTS

UPHOLSTERY ON REQUEST / REVETEMENT SUR REQUETE / ÜBERZUG AUF ANFRAGE

D04/D06	E02/E03/E04	I01/I02	M02/M03
690 PTS	732 PTS	865 PTS	934 PTS

BASE / BASE / GESTELL

	Powder coated aluminium 5-star base, silver finish Piètement 5 branches en alu avec plaque en teinte <i>5-Sternfußkreuz aus Aluminium, Ausführung Silber pulverbeschichtet</i>	BAA10	=
	Powder coated aluminium 5-star base, white finish Piètement 5 branches en alu verni blanc avec plaque en teinte <i>5-Sternfußkreuz aus Aluminium, Ausführung Weiß pulverbeschichtet</i>	BAA11	=

ACCESSORIES / ACCESSOIRES / ZUBEHÖR

	Chrome steel armrest Accoudoir en acier chromé <i>Verchromte Armlehne aus Stahl</i>	BRF15CR	+134 PTS
	Silver painted steel armrest Accoudoir en acier verni alu <i>Armlehne aus Stahl Aluminium lackiert</i>	BRF15VA	+134 PTS
	White painted steel armrest Accoudoir en acier verni blanc <i>Armlehne aus Stahl Weiß lackiert</i>	BRF15VB	+134 PTS
	Anthracite painted steel armrest Accoudoir en acier verni gris ombre <i>Armlehne aus Stahl Dunkelgrau lackiert</i>	BRF15VO	+134 PTS
	Die-cast brushed aluminium armrest Accoudoir en alu brossé <i>Armlehne aus gebürstetem Aluminiumdruckguss</i>	BRF16	+156 PTS

Celsius wooden chair

Chaise Celsius bois

Stuhl Celsius Holz

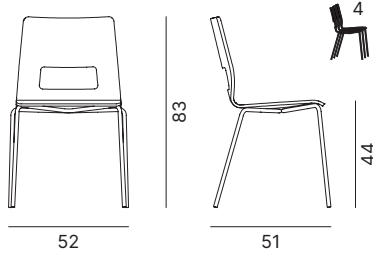

 2 box
2 u. x box
0,350 M³

 12,00
14,00

Cod. OCELSV03

Lacquered 10mm beech plywood shell; Ø16mm 2mm chrome steel frame; spacers under the seat make the chair stackable; polyethylene glides.

Coque en multi-plis de hêtre ép.10 mm, laqué; cadre en acier chromé Ø16×2; entretoises sous-assise pour empilabilité; patins en polyéthylène.

Sitzschale aus 10 mm starkem Buchensperrholz, lackiert; Gestell aus verchromtem Stahl Ø16×2; Abstandhalter unter dem Sitz für Stapelbarkeit; Fußgleiter aus Polyethylen.



Depending on the surface the color may vary slightly from the reference (RAL / NCS) provided.

En fonction de la surface, la couleur peut varier légèrement par rapport à la référence (RAL / NCS) fournie.

Je nach Oberfläche kann die Farbe in Bezug auf die RAL/NCS Referenz abweichen.

 EN 16139 Level 1

FINISH OPTIONS / FINITION / AUSFÜHRUNG

LB	LO	LH	NW
222 PTS	222 PTS	222 PTS	222 PTS

ACCESSORIES / ACCESSOIRES / ZUBEHÖR



Set of silent anti-scratch felt pads and glides

Kit de patins de feutres et patins anti-rayures et anti-bruit
Kit kratzfesten und geräuschkämpfenden Filzgleiter.

ACC12

+17 PTS

ON REQUEST ONLY / SUR REQUETE / AUF ANFRAGE



Gold powder coated frame

Structure vernie or
Gestell Gold lackiert

OR

+131 PTS



Bronze powder coated frame

Structure vernie bronze
Gestell Bronze lackiert

BR

+131 PTS



Corten powder coated frame

Structure vernie corten
Gestell Corten lackiert

CO

+131 PTS



Powder coated frame in a special finish, 6-unit minimum order

Cadre en coloris spéciaux, à partir de 6 pièces

Gestell: Sonderlackierung nach Kundenwunsch, ab 6 Stück

Price on request for special varnish finishes / Pour vernis spécifiques, devis sur requête / Sonderlackfarben auf Anfrage

VERN

+83 PTS



Powder coated shell in a special finish, 8-unit minimum order

Coque en coloris spéciaux, à partir de 8 pièces

Sitzschale: Sonderlackierung nach Kundenwunsch, ab 8 Stück

Price on request for special varnish finishes / Pour vernis spécifiques, devis sur requête / Sonderlackfarben auf Anfrage

VERN

+28 PTS

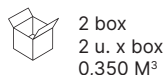
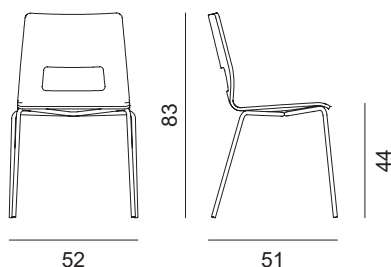

Cod. OCELSV02

Lacquered 10mm beech plywood shell; slab polyurethane foam seat; Ø16mm 2mm chrome steel frame; polyethylene glides.

Coque en multi-plis de hêtre ép.10 mm, laqué; rembourrage en blocs de mousse en polyuréthane expansée; cadre en acier chromé Ø16×2; patins en polyéthylène.

Sitzschale aus 10 mm starkem Buchensperrholz, lackiert; Sitzpolsterung aus in Blöcke geschnittenem Polyurethanschaum; Gestell aus verchromtem Stahl Ø16×2; Fußgleiter aus Polyethylen.

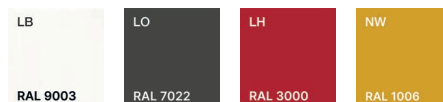

Depending on the surface the color may vary slightly from the reference (RAL / NCS) provided.
En fonction de la surface, la couleur peut varier légèrement par rapport à la référence (RAL / NCS) fournie.
Je nach Oberfläche kann die Farbe in Bezug auf die RAL/NCS Referenz abweichen.

CATAS EN 16139 Level 1

CUSHION UPHOLSTERY / REVETEMENT COUSSIN / KISSENBEZUG

B01/B03	C01/C05	E01	P01
262 PTS	276 PTS	296 PTS	329 PTS

UPHOLSTERY / REVETEMENT / BEZUG

D02/D03
280 PTS

CUSHION UPHOLSTERY ON REQUEST / REVETEMENT COUSSIN SUR REQUETE / ÜBERZUG KISSEN AUF ANFRAGE

D04/D06	E02/E03/E04	I01/I02
280 PTS	296 PTS	340 PTS

ACCESSORIES / ACCESSOIRES / ZUBEHÖR

	Set of silent anti-scratch felt pads and glides Kit de patins de feutres et patins anti-rayures et anti-bruit Kit kratzfesten und geräuschkämpfenden Filzgleiter.	ACC12	+17 PTS
--	--	-------	---------

ON REQUEST ONLY / SUR REQUETE / AUF ANFRAGE

	Gold powder coated frame Structure vernie or Gestell Gold lackiert	OR	+131 PTS
	Bronze powder coated frame Structure vernie bronze Gestell Bronze lackiert	BR	+131 PTS
	Corten powder coated frame Structure vernie corten Gestell Corten lackiert	CO	+131 PTS
	Powder coated frame in a special finish, 6-unit minimum order Cadre en coloris spéciaux, à partir de 6 pièces Gestell: Sonderlackierung nach Kundenwunsch, ab 6 Stück <small>Price on request for special varnish finishes / Pour vernis spécifiques, devis sur requête / Sonderlackfarben auf Anfrage</small>	VERN	+83 PTS
	Powder coated shell in a special finish, 8-unit minimum order Coque en coloris spéciaux, à partir de 8 pièces Sitzschale: Sonderlackierung nach Kundenwunsch, ab 8 Stück <small>Price on request for special varnish finishes / Pour vernis spécifiques, devis sur requête / Sonderlackfarben auf Anfrage</small>	VERN	+28 PTS

Celsius fully upholstered chair

Chaise Celsius tapissée

Stuhl Celsius gepolstert

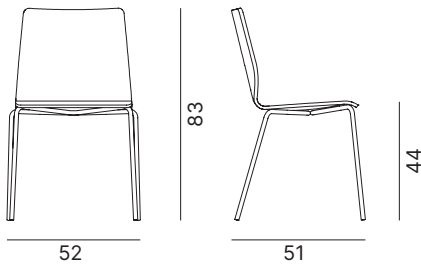

Cod. OCELSV11

Fully upholstered 10mm beech plywood shell; slab polyurethane foam; Ø16mm 2mm chrome steel frame; polyethylene glides.

Coque en multi-plis de hêtre ép. 10, laqué; rembourrage en blocs de mousse en polyuréthane expansée; cadre en acier chromé Ø16x2; patins en polyéthylène.

Sitzschale aus 10 mm starkem Buchensperrholz, lackiert; Polsterung aus in Blöcke geschnittenem Polyurethanschaum; Rahmen aus verchromtem Stahl Ø16x2; Fußgleiter aus Polyethylen.

CATAS EN 16139 Level 1

 2 box
2 u. x box
0,350 M³

 13,00
15,00

UPHOLSTERY / REVETEMENT / BEZUG

B01/B03	C01/C05	D02/D03	E01	P01
248 PTS	275 PTS	284 PTS	323 PTS	423 PTS

UPHOLSTERY ON REQUEST / REVETEMENT SUR REQUETE / ÜBERZUG AUF ANFRAGE

D04/D06	E02/E03/E04	I01/I02
284 PTS	323 PTS	423 PTS

ACCESSORIES / ACCESSOIRES / ZUBEHÖR







Set of silent anti-scratch felt pads and glides
Kit de patins de feutres et patins anti-rayures et anti-bruit
Kit kratzfesten und geräuschkämpfenden Filzgleiter.

ACC12

+17 PTS

ON REQUEST ONLY / SUR REQUETE / AUF ANFRAGE

	Gold powder coated frame Structure vernie or Gestell Gold lackiert	OR	+131 PTS
	Bronze powder coated frame Structure vernie bronze Gestell Bronze lackiert	BR	+131 PTS
	Corten powder coated frame Structure vernie corten Gestell Corten lackiert	CO	+131 PTS
	Powder coated frame in a special finish, 6-unit minimum order Cadre en coloris spéciaux, à partir de 6 pièces Gestell: Sonderlackierung nach Kundenwunsch, ab 6 Stück Price on request for special varnish finishes / Pour vernis spécifiques, devis sur requête / Sonderlackfarben auf Anfrage	VERN	+83 PTS

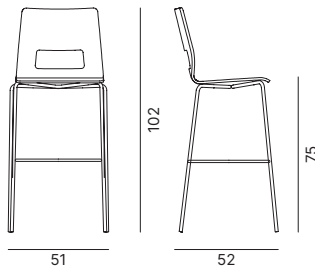

Cod. OCELSS01

Lacquered 10mm beech plywood shell; Ø16mm 2mm chrome steel frame; polyethylene glides.

Coque en multi-plis de hêtre ép. 10, laqué; cadre en acier chromé Ø16×2; patins en polyéthylène.

Sitzschale aus 10 mm starkem Buchensperrholz, lackiert; Gestell aus verchromtem Stahl Ø16×2; Fußgleiter aus Polyethylen.

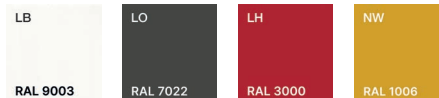

2 box
2 u. x box
0,350 M³



14,00
17,00

Depending on the surface the color may vary slightly from the reference (RAL / NCS) provided.

En fonction de la surface, la couleur peut varier légèrement par rapport à la référence (RAL / NCS) fournie.

Je nach Oberfläche kann die Farbe in Bezug auf die RAL/NCS Referenz abweichen.

FINISH OPTIONS / FINITION / AUSFÜHRUNG

LB	LO	LH	NW
280 PTS	280 PTS	280 PTS	280 PTS

ACCESSORIES / ACCESSOIRES / ZUBEHÖR



Set of silent anti-scratch felt pads and glides
Kit de patins de feutres et patins anti-rayures et anti-bruit
Kit kratzfesten und geräuschkämpfenden Filzgleiter.

ACC12

+17 PTS

ON REQUEST ONLY / SUR REQUETE / AUF ANFRAGE



Gold powder coated frame
Structure vernie or
Gestell Gold lackiert

OR

+131 PTS



Bronze powder coated frame
Structure vernie bronze
Gestell Bronze lackiert

BR

+131 PTS



Corten powder coated frame
Structure vernie corten
Gestell Corten lackiert

CO

+131 PTS



Powder coated frame in a special finish, 2-unit minimum order
Cadre en coloris spéciaux, à partir de 2 pièces
Gestell: Sonderlackierung nach Kundenwunsch, ab 2 Stück

Price on request for special varnish finishes / Pour vernis spécifiques, devis sur requête / Sonderlackfarben auf Anfrage

VERN

+83 PTS



Powder coated shell in a special finish, 8-unit minimum order
Coque en coloris spéciaux, à partir de 8 pièces
Sitzschale: Sonderlackierung nach Kundenwunsch, ab 8 Stück

Price on request for special varnish finishes / Pour vernis spécifiques, devis sur requête / Sonderlackfarben auf Anfrage

VERN

+28 PTS

Celsius wooden stool, height adjustable swivel base

Tabouret bois Celsius, base pivotante et vérin

Barhocker Celsius Holz, dreh- und höhenverstellbar

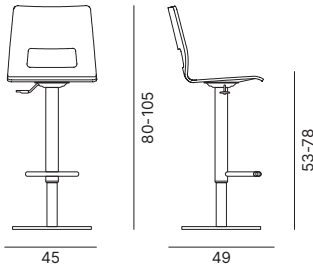

Cod. OCELSS02

Lacquered 10mm beech plywood shell. Chrome weighted flat base with height adjustable footrest.

Coque en multi-plis de hêtre ép. 10, laqué. Piètement chromé avec appuie-pieds et lift.

Sitzschale aus 10 mm starkem Buchensperrholz, lackiert. Gestell verchromt, inkl. Fußstütze höhenverstellbar.



 1 box
1 u. x box
0,350 M³

 19,50
21,00

Depending on the surface the color may vary slightly from the reference (RAL / NCS) provided.

En fonction de la surface, la couleur peut varier légèrement par rapport à la référence (RAL / NCS) fournie.

Je nach Oberfläche kann die Farbe in Bezug auf die RAL/NCS Referenz abweichen.

FINISH OPTIONS / FINITION / AUSFÜHRUNG

LB	LO	LH	NW
465 PTS	465 PTS	465 PTS	465 PTS

ON REQUEST ONLY / SUR REQUETE / AUF ANFRAGE



Powder coated shell in a special finish, 8-unit minimum order

Coque en coloris spéciaux, à partir de 8 pièces

Sitzschale: Sonderlackierung nach Kundenwunsch, ab 8 Stück

Price on request for special varnish finishes / Pour vernis spécifiques, devis sur requête / Sonderlackfarben auf Anfrage

VERN

+28 PTS

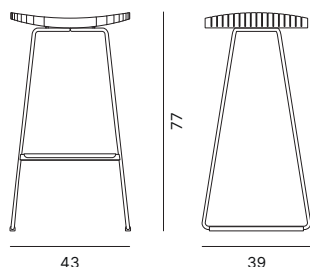

Cod. OCLARS01

Seat in solid ash wood cross grain staves, varnished; frame in Ø12mm steel tube, powder coated; stainless steel footrest; polyethylene glides.

Assise en lattes de frêne massif à grain croisé, vernis ; structure en tige d'acier de 12 mm ; repose-pieds en acier inoxydable ; patins en polyéthylène.

Sitz in Daunen aus massiver Esche mit gekreuzten Narben, lackiert; Gestell aus Rundstahl Durchmesser 12mm lackiert; Fußstütze aus Edelstahl; Füße aus Polyethylen.



1 box
 1 u. x box
 0,140 M³



#VALUE!,00
 10,00





FINISH OPTIONS / FINITION / AUSFÜHRUNG

FK	FN	FG
456 PTS	456 PTS	456 PTS

FRAME / CADRE / GESTELL

	Powder coated frame in white Cadre verni blanc Gestell Weiß lackiert	FSB32	=
	Powder coated frame in anthracite Cadre verni gris ombre Gestell Dunkelgrau lackiert	FST29	=

ON REQUEST ONLY / SUR REQUETE / AUF ANFRAGE

	Gold powder coated frame Structure vernie or Gestell Gold lackiert	OR	+95 PTS
	Bronze powder coated frame Structure vernie bronze Gestell Bronze lackiert	BR	+127 PTS
	Corten powder coated frame Structure vernie corten Gestell Corten lackiert	CO	+127 PTS
	Powder coated seat in a special finish, minimum 6 units Peinture assise personnalisée, minimum 6 pièces Lackierung Sitz nach Kundenwunsch, mindestens 6 Stück <small>Price on request for special varnish finishes / Pour vernis spécifiques, devis sur requête / Sonderlackfarben auf Anfrage</small>	VERN	+32 PTS
	Powder coated frame in a special finish, 6-unit minimum order Cadre en coloris spéciaux, à partir de 6 pièces Gestell: Sonderlackierung nach Kundenwunsch, ab 6 Stück <small>Price on request for special varnish finishes / Pour vernis spécifiques, devis sur requête / Sonderlackfarben auf Anfrage</small>	VERN	+95 PTS

Clark stool H 60 cm
 Tabouret Clark H 60 cm
 Hocker Clark H 60cm

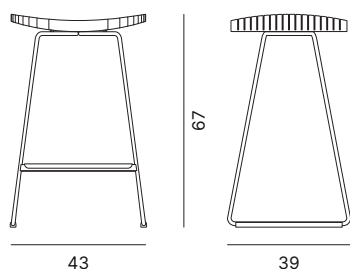

Cod. OCLARS02

Seat in solid ash wood cross grain staves, varnished; frame in Ø12mm steel tube, powder coated; stainless steel footrest; polyethylene glides.

Assise en lattes de frêne massif à grain croisé, vernis ; structure en tige d'acier de 12 mm ; repose-pieds en acier inoxydable ; patins en polyéthylène.

Sitz in Daunen aus massiver Esche mit gekreuzten Narben, lackiert; Gestell aus Rundstahl Durchmesser 12mm lackiert; Fußstütze aus Edelstahl; Füße aus Polyethylen.



1 box
 1 u. x box
 0,140 M³

8,00
 9,50

FINISH OPTIONS / FINITION / AUSFÜHRUNG

FK	FN	FG
449 PTS	449 PTS	449 PTS

FRAME / CADRE / GESTELL

	Powder coated frame in white Cadre verni blanc Gestell Weiß lackiert	FSB33	=
	Powder coated frame in anthracite Cadre verni gris ombre Gestell Dunkelgrau lackiert	FST30	=

ON REQUEST ONLY / SUR REQUETE / AUF ANFRAGE

	Gold powder coated frame Structure vernie or Gestell Gold lackiert	OR	+95 PTS
	Bronze powder coated frame Structure vernie bronze Gestell Bronze lackiert	BR	+127 PTS
	Corten powder coated frame Structure vernie corten Gestell Corten lackiert	CO	+127 PTS
	Powder coated seat in a special finish, minimum 6 units Peinture assise personnalisée, minimum 6 pièces Lackierung Sitz nach Kundenwunsch, mindestens 6 Stück <small>Price on request for special varnish finishes / Pour vernis spécifiques, devis sur requête / Sonderlackfarben auf Anfrage</small>	VERN	+32 PTS
	Powder coated frame in a special finish, 6-unit minimum order Cadre en coloris spéciaux, à partir de 6 pièces Gestell: Sonderlackierung nach Kundenwunsch, ab 6 Stück <small>Price on request for special varnish finishes / Pour vernis spécifiques, devis sur requête / Sonderlackfarben auf Anfrage</small>	VERN	+95 PTS

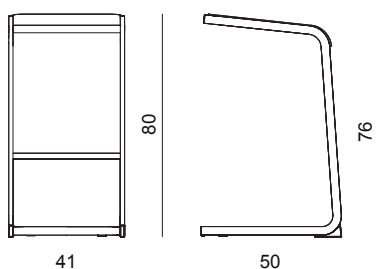

Cod. OCSTOA01

Seat inner frame made from solid birch wood; injection molded polyurethane foam; powder coated steel tube frame; stainless steel footrest; anti-tip polyethylene glides, include felt pads.

Assise interne en bouleau; rembourrage en polyuréthane expansée; cadre en tube d'acier verni à poudre époxy; appuie-pieds en acier inox; patins feutrés anti-basculement inclus.

Innensitz aus Birke; Polsterung aus geschäumtem Polyurethan; Gestell aus epoxidpulverbeschichtetem Stahlrohr; Fußstütze aus Edelstahl; Kippschutzfüße mit Filzgleitern.

CATAS EN 16139 Level 1



1 box
1 u. x box
0,180 M³



8,50
10,00

UPHOLSTERY / REVETEMENT / BEZUG

B01/B03	C01/C05	D02/D03/D05	E01	P01
408 PTS	418 PTS	423 PTS	432 PTS	487 PTS

UPHOLSTERY ON REQUEST / REVETEMENT SUR REQUETE / ÜBERZUG AUF ANFRAGE

D04/D06	E02/E03/E04	I01/I02
423 PTS	432 PTS	466 PTS

FRAME / CADRE / GESTELL

	Powder coated frame in silver with white glides Cadre verni alu avec patins en blanc opalin Gestell Aluminium lackiert mit weißen opalisierten Gleitern	FSG01	=
	Powder coated frame in white with matching glides Cadre verni blanc avec patins en blanc opalin Gestell Weiß lackiert mit weißen opalisierten Gleitern	FSB03	=
	Powder coated frame in anthracite with matching glides Cadre verni gris ombre avec patins en gris ombre Gestell Dunkelgrau lackiert mit dunkelgrauen Gleitern	FST03	=

ON REQUEST ONLY / SUR REQUETE / AUF ANFRAGE



Powder coated frame in a special finish, 6-unit minimum order

Cadre en coloris spéciaux, à partir de 6 pièces
Gestell: Sonderlackierung nach Kundenwunsch, ab 6 Stück

Price on request for special varnish finishes / Pour vernis spécifiques, devis sur requête / Sonderlackfarben auf Anfrage

VERN

+129 PTS

C-stool low

Tabouret bas C-stool
Hocker C-Stool niedrig

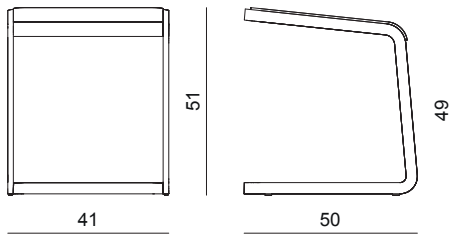

Cod. OCSTOB01

Seat inner frame made from solid birch wood; injection molded polyurethane foam; powder coated steel tube frame; stainless steel footrest; glides complete with felt pads.

Assise interne en bouleau; rembourrage en polyuréthane expansée; cadre en tube d'acier verni à poudre époxy; appuie-pieds en acier inox; patins feutrés anti-basculement inclus.

Innensitz aus Birke; Polsterung aus geschäumtem Polyurethan; Gestell aus epoxidpulverbeschichtetem Stahlrohr; Fußstütze aus Edelstahl; Füße mit Filzgleitern.

CATAS EN 16139 Level 1

 1 box
1 u. x box
0,130 M³

 7,50
8,50

UPHOLSTERY / REVETEMENT / BEZUG

B01/B03	C01/C05	D02/D03/D05	E01	P01
304 PTS	318 PTS	322 PTS	332 PTS	393 PTS

UPHOLSTERY ON REQUEST / REVETEMENT SUR REQUETE / ÜBERZUG AUF ANFRAGE

D04/D06	E02/E03/E04	I01/I02
322 PTS	332 PTS	367 PTS

FRAME / CADRE / GESTELL

	Powder coated frame in silver with white glides Cadre verni alu avec patins en blanc opalin Gestell Aluminium lackiert mit weißen opalisierten Gleitern	FSG01	=
	Powder coated frame in white with matching glides Cadre verni blanc avec patins en blanc opalin Gestell Weiß lackiert mit weißen opalisierten Gleitern	FSB03	=
	Powder coated frame in anthracite with matching glides Cadre verni gris ombre avec patins en gris ombre Gestell Dunkelgrau lackiert mit dunkelgrauen Gleitern	FST03	=

ON REQUEST ONLY / SUR REQUETE / AUF ANFRAGE

	Powder coated frame in a special finish, 6-unit minimum order Cadre en coloris spéciaux, à partir de 6 pièces Gestell: Sonderlackierung nach Kundenwunsch, ab 6 Stück <small>Price on request for special varnish finishes / Pour vernis spécifiques, devis sur requête / Sonderlackfarben auf Anfrage</small>	VERN	+129 PTS
---	--	-------------	----------

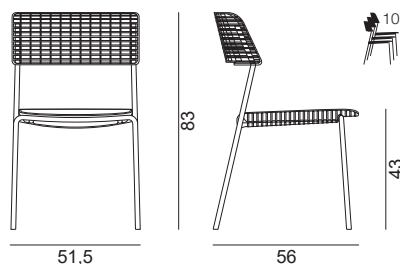

1 box
2 u. x box
0,330 M³

KG 10,00
13,00

Cod. OCELLV01

Multipurpose stackable chair with 4-leg metal frame. Seat and back in a rigid 3D polypropylene mesh available in a range of colours. Metal frame made from 2mm thick 18mmØ steel tube, in chrome or epoxy powder coated in a range of colours. Matching polypropylene glides (in black with chromed frame).





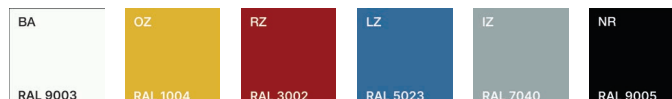

Chaise collectivité empilable avec structure 4 pieds. Assise et dossier en grille 3D de polypropylène différentes couleurs. Structure 4 pieds en tube d'acier Ø18mm ép. 2mm verni à poudre époxy différents coloris ou chromé; patins en polypropylène en teinte (noir pour cadre chromé).

Stapelbarer Objektstuhl mit 4-Fuß Gestell und Armlehnen. Sitz und Rückenlehne aus 3D-Polypropylen-Gitter in verschiedenen Farben. 4-Fuß Gestell aus Stahlrohr Ø18mm 2mm stark in verschiedenen Farben epoxydpulverbeschichtet oder verchromt; Polypropylenfüße in angepasster Farbe (schwarz für verchromten Rahmen).



Depending on the surface the color may vary slightly from the reference (RAL / NCS) provided.
En fonction de la surface, la couleur peut varier légèrement par rapport à la référence (RAL / NCS) fournie.
Je nach Oberfläche kann die Farbe in Bezug auf die RAL/NCS Referenz abweichen.

FRAME / CADRE / GESTELL

	Chrome frame Cadre chromé Verchromtes Gestell	FSC32	191 PTS
	Frame powder coated in RAL 9005 black Cadre verni noir RAL 9005 Gestell schwarz lackiert RAL 9005	FSN07	179 PTS
	Frame powder coated in RAL 7040 grey Cadre verni gris RAL 7040 Gestell grau lackiert RAL 7040	FSG25	179 PTS
	Frame powder coated in RAL 1004 golden yellow Cadre verni jaune or RAL 1004 Gestell gold lackiert RAL 1004	FSY01	179 PTS
	Frame powder coated in RAL 5023 blue Cadre verni bleu RAL 5023 Gestell blau lackiert RAL 5023	FSU01	179 PTS
	Frame powder coated in RAL 3002 red Cadre verni rouge RAL 3002 Gestell rot lackiert RAL 3002	FSR01	179 PTS
	Frame powder coated in RAL 9003 white Cadre verni blanc RAL 9003 Gestell weiß lackiert RAL 9003	FSB29	179 PTS

Cell chair, 4-metal leg frame with arms

Chaise Cell, 4 pieds métal avec accoudoirs

Cell stuhl, 4 Metallbeine mit Armlehnen

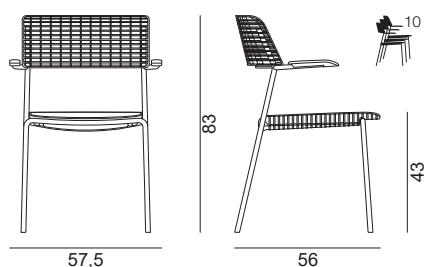

Cod. OCELLV03

Multipurpose stackable chair with 4-leg metal frame and arms. Seat and back in a rigid 3D polypropylene mesh available in a range of colours. Matching polypropylene arms. Metal frame made from 2mm thick 18mmØ steel tube, in chrome or epoxy powder coated in a range of colours. Matching polypropylene glides (in black with chromed frame).

Chaise collectivité empilable avec structure 4 pieds avec accoudoirs. Assise et dossier en grille 3D de polypropylène différentes couleurs. Accoudoirs en polypropylène en teinte avec l'assise et le dossier. Structure 4 pieds en tube d'acier Ø18mm ép. 2mm verni à poudre époxy différents coloris ou chromé; patins en polypropylène en teinte (noir pour cadre chromé).





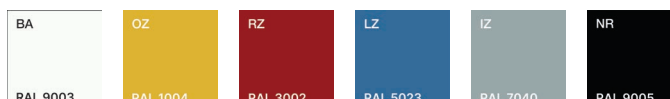

Stapelbarer Objektstuhl mit 4-Fuß Gestell und Armlehnen. Sitz und Rückenlehne aus 3D-Polypropylen-Gitter in verschiedenen Farben. Polypropylen-Armlehnen mit Sitz und Rückenlehne farblich abgestimmt. 4-Fuß Gestell aus Stahlrohr Ø 18mm 2mm stark in verschiedenen Farben epoxydpuverbeschichtet oder verchromt; Polypropylenfüße in angepasster Farbe (schwarz für verchromten Rahmen).

1 box
2 u. x box
0,330 M³

KG
10,40
13,40



Depending on the surface the color may vary slightly from the reference (RAL / NCS) provided.
En fonction de la surface, la couleur peut varier légèrement par rapport à la référence (RAL / NCS) fournie.
Je nach Oberfläche kann die Farbe in Bezug auf die RAL/NCS Referenz abweichen.

FRAME / CADRE / GESTELL		
	Chrome frame with integral arms Cadre avec accoudoirs chromés Verchromtes Gestell mit Armlehnen	FSC33 213 PTS
	Frame with arms powder coated in RAL 9005 black Cadre avec accoudoirs verni noir RAL 9005 Gestell mit lackierten Armlehnen, schwarz, RAL 9005	FSN08 198 PTS
	Frame with arms powder coated in RAL 7040 grey Cadre avec accoudoirs verni gris RAL 7040 Gestell mit lackierten Armlehnen, grau, RAL 7040	FSG26 198 PTS
	Frame with arms powder coated in RAL 1004 golden yellow Cadre avec accoudoirs verni jaune or RAL 1004 Gestell mit lackierten Armlehnen, goldgelb, RAL 1004	FSY02 198 PTS
	Frame with arms powder coated in RAL 5023 blue Cadre avec accoudoirs verni bleu RAL 5023 Gestell mit lackierten Armlehnen, blau, RAL 5023	FSU02 198 PTS
	Frame with arms powder coated in RAL 9005 red Cadre avec accoudoirs verni rouge RAL 9005 Gestell mit lackierten Armlehnen, rot, RAL 9005	FSR02 198 PTS
	Frame with arms powder coated in RAL 9003 white Cadre avec accoudoirs verni blanc RAL 9003 Gestell mit lackierten Armlehnen, weiß, RAL 9003	FSB30 198 PTS

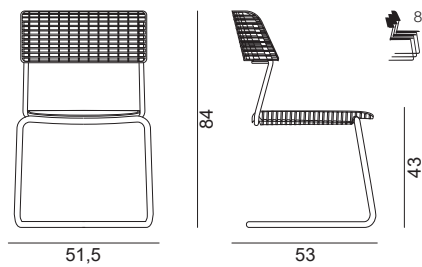

1 box
 2 u. x box
 0,330 M³

KG 12,80
 15,80

Cod. OCELLV02

Multipurpose stackable chair with cantilever base. Seat and back in a rigid 3D polypropylene mesh available in a range of colours. Metal frame made from 2.5mm thick 22mmØ chromed steel tube. Polypropylene glides.

Chaise collectivité empilable avec structure luge. Assise et dossier en grille 3D de polypropylène différentes couleurs. Structure en tube d'acier chromé Ø22mm ép. 2,5mm; patins en polypropylène.

Stapelbarer Objektstuhl mit freitragendem Kufengestell mit Armlehnen. Sitz und Rückenlehne aus 3D-Polypropylen-Gitter in verschiedenen Farben. Gestell aus verchromtem Stahlrohr Ø 22mm 2,5mm stark; Füße aus Polypropylen.

BA RAL 9003	OZ RAL 1004	RZ RAL 3002	LZ RAL 5023	IZ RAL 7040	NR RAL 9005
----------------	----------------	----------------	----------------	----------------	----------------

Depending on the surface the color may vary slightly from the reference (RAL / NCS) provided.
 En fonction de la surface, la couleur peut varier légèrement par rapport à la référence (RAL / NCS) fournie.
 Je nach Oberfläche kann die Farbe in Bezug auf die RAL/NCS Referenz abweichen.

FRAME / CADRE / GESTELL



Chrome frame
 Cadre chromé
 Verchromtes Gestell

FSC34

251 PTS

Cell chair, sled base with arms

Chaise Cell, luge métal avec accoudoirs

Cell stuhl, Metallschlitzen mit Armlehnen

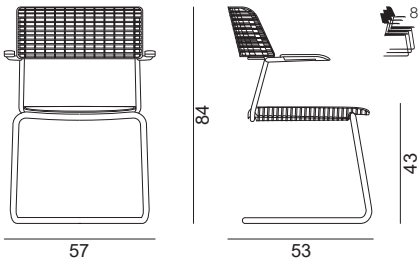

Cod. OCELLV04

Multipurpose stackable chair with cantilever base and arms. Seat and back in a rigid 3D polypropylene mesh available in a range of colours. Matching polypropylene arms. Metal frame made from 2.5mm thick 22mmØ chromed steel tube. Polypropylene glides.

Chaise collectivité empilable avec structure luge. Assise et dossier en grille 3D de polypropylène différentes couleurs. Accoudoirs polypropylène en teinte avec assise et dossier. Structure en tube d'acier chromé Ø22mm ép. 2,5mm; patins en polypropylène.

Stapelbarer Objektstuhl mit freitragendem Kufengestell mit Armlehnen. Sitz und Rückenlehne aus 3D-Polypropylen-Gitter in verschiedenen Farben. Polypropylen-Armlehnen mit Sitz und Rückenlehne farblich abgestimmt. Gestell aus verchromtem Stahlrohr Ø 22mm 2,5mm stark; Füße aus Polypropylen.

1 box
2 u. x box
0,330 M³

13,40
16,40

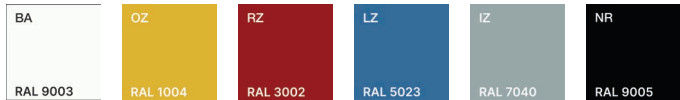

Depending on the surface the color may vary slightly from the reference (RAL / NCS) provided.
En fonction de la surface, la couleur peut varier légèrement par rapport à la référence (RAL / NCS) fournie.
Je nach Oberfläche kann die Farbe in Bezug auf die RAL/NCS Referenz abweichen.

FRAME / CADRE / GESTELL



Chrome frame with integral arms
Cadre avec accoudoirs chromés
Verchromtes Gestell mit Armlehnen

FSC35

271 PTS

CLOSE

FULL POLYPROPYLENE SHELL
COQUE EN POLYPROPYLÈNE
SCHALE AUS POLYPROPYLEN

Close polypropylene chair, 4-metal leg frame Chaise Close polypropylène, 4 pieds métal Stuhl Close-Polypropylen, 4 Metallbeine

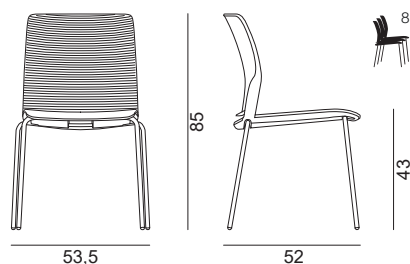

Cod. OCLOSV01

Polypropylene seat and back, frame made from ø16mm steel tube, polypropylene glides.
Assise et dossier en polypropylène, structure en tube d'acier Ø16mm; patins en polypropylène.
Sitz und Rückenlehne aus Polypropylen; Gestell aus Stahlrohr Ø16mm; FüÙe aus Polypropylen.



1 box
2 u. x box
0,330 M³



KG 11,20
14,20

Depending on the surface the color may vary slightly from the reference (RAL / NCS) provided.
En fonction de la surface, la couleur peut varier légèrement par rapport à la référence (RAL / NCS) fournie.
Je nach Oberfläche kann die Farbe in Bezug auf die RAL/NCS Referenz abweichen.



FINISH OPTIONS / FINITION / AUSFÜHRUNG

BA	RS	GR	NR
167 PTS	167 PTS	167 PTS	167 PTS

FRAME / CADRE / GESTELL

	Chrome frame Cadre chromé Verchromtes Gestell	FSC27	=
	Powder coated frame in white Cadre verni blanc Gestell Weiß lackiert	FSB27	=
	Powder coated frame in black Cadre verni noir Gestell schwarz lackiert	FSN27	=

ACCESSORIES / ACCESSOIRES / ZUBEHÖR

	Set of silent anti-scratch felt pads and glides Kit de patins de feutres et patins anti-rayures et anti-bruit Kit kratzfesten und geräuscdämpfenden Filzgleiter.	ACC12	+19 PTS
	Mobile trolley (up to 10 chairs) Chariot de transport (capacité 10 chaises) Transportwagen (für bis zu 10 Stühle)	3OACC17	+546 PTS

ON REQUEST ONLY / SUR REQUETE / AUF ANFRAGE

	Fire retardant shell in black Version non-feu, coques en noir Feuerfeste Ausführung, schwarze Schalen Production lead time on request / Délai de fabrication sur requête / Lieferzeit auf Anfrage	IGNI	+52 PTS
---	---	------	---------

Close polypropylene chair, 4-metal leg frame with arms
 Chaise Close polypropylène, 4 pieds métal avec accoudoirs
 Close Stuhl aus Polypropylen, 4 Metallbeine mit Armlehnen

CLOSE

FULL POLYPROPYLENE SHELL
 COQUE EN POLYPROPYLENE
 SCHALE AUS POLYPROPYLEN

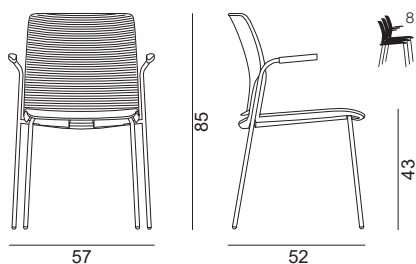

Cod. OCLOSVO3

Polypropylene seat and back, matching polypropylene arms, frame made from ø16mm steel tube, polypropylene glides.

Assise et dossier en polypropylène; accoudoirs en polypropylène en teinte; structure en tube d'acier Ø16mm; patins en polypropylène.

Sitz und Rückenlehne aus Polypropylen; Armlehnen aus Polypropylen farblich abgestimmt; Gestell aus Stahlrohr Ø 16 mm; FüÙe aus Polypropylen.

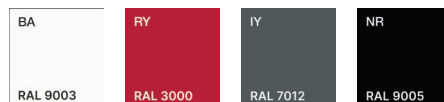

1 box
 2 u. x box
 0,330 M³

12,20
 15,20

Depending on the surface the color may vary slightly from the reference (RAL / NCS) provided.
 En fonction de la surface, la couleur peut varier légèrement par rapport à la référence (RAL / NCS) fournie.
 Je nach Oberfläche kann die Farbe in Bezug auf die RAL/NCS Referenz abweichen.

FINISH OPTIONS / FINITION / AUSFÜHRUNG

BA	RS	GR	NR
207 PTS	207 PTS	207 PTS	207 PTS

FRAME / CADRE / GESTELL

	Chrome frame Cadre chromé Verchromtes Gestell	FSC28	=
	Powder coated frame in white Cadre verni blanc Gestell Weiß lackiert	FSB28	=
	Powder coated frame in black Cadre verni noir Gestell schwarz lackiert	FSN28	=

ACCESSORIES / ACCESSOIRES / ZUBEHÖR

	Set of silent anti-scratch felt pads and glides Kit de patins de feutres et patins anti-rayures et anti-bruit Kit kratzfesten und geräuschkämpfenden Filzgleiter.	ACC12	+19 PTS
	Mobile trolley (up to 10 chairs) Chariot de transport (capacité 10 chaises) Transportwagen (für bis zu 10 Stühle)	3OACC17	+546 PTS

ON REQUEST ONLY / SUR REQUETE / AUF ANFRAGE

	Fire retardant shell in black Version non-feu, coques en noir Feuerfeste Ausführung, schwarze Schalen Production lead time on request / Délai de fabrication sur requête / Lieferzeit auf Anfrage	IGNI	+52 PTS
--	---	------	---------

CLOSE

FULL POLYPROPYLENE SHELL
COQUE EN POLYPROPYLÈNE
SCHALE AUS POLYPROPYLEN

Close polypropylene chair, sled base in metal Chaise Close polypropylène, luge métal Close Stuhl Polypropylen, Kufengestell aus Metall

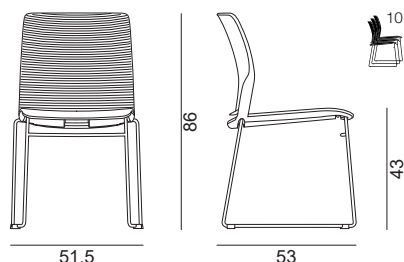

Cod. OCLOSV02

Polypropylene seat and back, frame made from ø11mm steel rod, polypropylene glides.

Assise et dossier en polypropylène, structure en tube d'acier Ø11mm; patins en polypropylène.

Sitz und Rückenlehne aus Polypropylen; Gestell aus Stahlrohr Ø11mm; Füße aus Polypropylen.

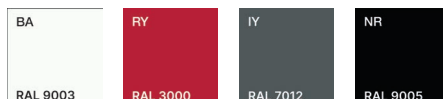

Depending on the surface the color may vary slightly from the reference (RAL / NCS) provided.

En fonction de la surface, la couleur peut varier légèrement par rapport à la référence (RAL / NCS) fournie.

Je nach Oberfläche kann die Farbe in Bezug auf die RAL/NCS Referenz abweichen.



1 box
2 u. x box
0,330 M³



14,00
17,00

CATAS EN 16139 Level 1



FINISH OPTIONS / FINITION / AUSFÜHRUNG

BA	RS	GR	NR
184 PTS	184 PTS	184 PTS	184 PTS

FRAME / CADRE / GESTELL

	Chrome frame Cadre chromé Verchromtes Gestell	FSC29	=
---	--	-------	---

ACCESSORIES / ACCESSOIRES / ZUBEHÖR

	Removable RH writing tablet Tablette écriroire à droite amovible Rechter klappbare und abnehmbare Tisch	TAV16	+93 PTS
	Linking device Accrochage pour chaises Verbinder für Stühle	3OACC16	+20 PTS
	Mobile trolley (up to 25 chairs) Chariot de transport (capacité 25 chaises) Transportwagen (für bis zu 25 Stühle)	3OACC17	+546 PTS

ON REQUEST ONLY / SUR REQUETE / AUF ANFRAGE

	Fire retardant shell in black Version non-feu, coques en noir Feuerfeste Ausführung, schwarze Schalen Production lead time on request / Délai de fabrication sur requête / Lieferzeit auf Anfrage	IGNI	+52 PTS
---	---	------	---------

Close polypropylene chair, sled base in metal with arms
 Chaise Close polypropylène, luge métal avec accoudoirs
 Close Stuhl aus Polypropylen, Kufengestell aus Metall mit Armlehnen

CLOSE

FULL POLYPROPYLENE SHELL
 COQUE EN POLYPROPYLENE
 SCHALE AUS POLYPROPYLEN

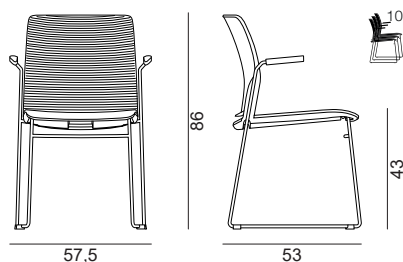

Cod. OCLOSV04

Polypropylene seat and back, matching polypropylene arms, frame made from ø11mm steel rod, polypropylene glides.

Assise et dossier en polypropylène; accoudoirs en polypropylène en teinte; structure en tube d'acier Ø11mm; patins en polypropylène.

Sitz und Rückenlehne aus Polypropylen; Armlehnen aus Polypropylen farblich abgestimmt; Gestell aus Stahlrohr Ø11 mm; Füße aus Polypropylen.

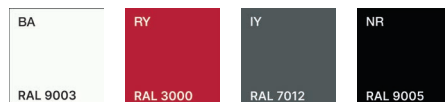

1 box
 2 u. x box
 0,330 M³

15,00
 18,00

Depending on the surface the color may vary slightly from the reference (RAL / NCS) provided.
 En fonction de la surface, la couleur peut varier légèrement par rapport à la référence (RAL / NCS) fournie.
 Je nach Oberfläche kann die Farbe in Bezug auf die RAL/NCS Referenz abweichen.

CATAS EN 16139 Level 1



FINISH OPTIONS / FINITION / AUSFÜHRUNG

BA	RS	GR	NR
235 PTS	235 PTS	235 PTS	235 PTS

FRAME / CADRE / GESTELL

	Chrome frame with integral arms Cadre chromé avec accoudoirs Verchromtes Gestell mit Armlehnen	FSC30	=
--	---	--------------	---

ACCESSORIES / ACCESSOIRES / ZUBEHÖR

	Linking device Accrochage pour chaises Verbinder für Stühle	3OACC16	+20 PTS
	Mobile trolley (up to 25 chairs) Chariot de transport (capacité 25 chaises) Transportwagen (für bis zu 25 Stühle)	3OACC17	+546 PTS

ON REQUEST ONLY / SUR REQUETE / AUF ANFRAGE

	Fire retardant shell in black Version non-feu, coques en noir Feuerfeste Ausführung, schwarze Schalen <small>Production lead time on request / Délai de fabrication sur requête / Lieferzeit auf Anfrage</small>	IGNI	+52 PTS
---	--	-------------	---------

CLOSE

FULL POLYPROPYLENE SHELL
COQUE EN POLYPROPYLENE
SCHALE AUS POLYPROPYLEN

Close polypropylene stool, sled base, 750mm high seat
Tabouret Close polypropylène, luge métal, luge métal, H 75
Close Barhocker aus Polypropylen, Metallkufen, H 75 cm

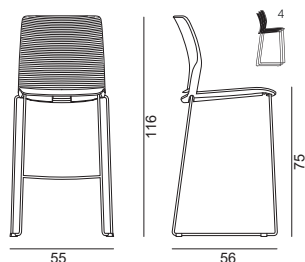

Cod. OCLOSS01

Polypropylene seat and back, frame made from ø12mm steel rod, includes footrest, polypropylene glides.

Assise et dossier en polypropylène, structure en tube d'acier Ø12mm; patins en polypropylène.
Sitz und Rückenlehne aus Polypropylen; Gestell aus Stahlrohr Ø12mm; FüÙe aus Polypropylen.

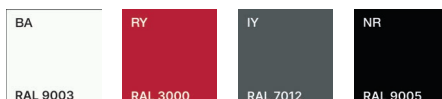

1 box
2 u. x box
0,420 M³



8,40
9,90

Depending on the surface the color may vary slightly from the reference (RAL / NCS) provided.

En fonction de la surface, la couleur peut varier légèrement par rapport à la référence (RAL / NCS) fournie.
Je nach Oberfläche kann die Farbe in Bezug auf die RAL/NCS Referenz abweichen.

FINISH OPTIONS / FINITION / AUSFÜHRUNG

BA	RS	GR	NR
251 PTS	251 PTS	251 PTS	251 PTS

FRAME / CADRE / GESTELL



Chrome frame
Cadre chromé
Verchromtes Gestell

FSC31

=

ON REQUEST ONLY / SUR REQUETE / AUF ANFRAGE



Fire retardant shell in black
Version non-feu, coques en noir
Feuerfeste Ausführung, schwarze Schalen

Production lead time on request / Délai de fabrication sur requête / Lieferzeit auf Anfrage

IGNI

+52 PTS

Close polypropylene chair, upholstered seat, 4-metal leg frame

Chaise Close polypropylène, assise tapissée, 4 pieds métal

Close Polypropylen-Stuhl, gepolsterter Sitz, 4 Metallbeine

CLOSE

PADDED SEAT
ASSISE TAPISSÉE
GEPOLSTERTER SITZ

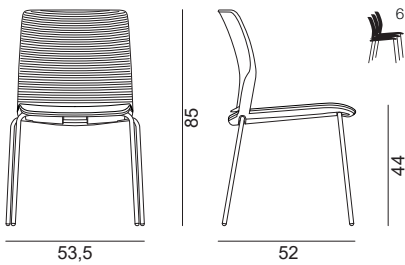

Cod. OCLOS11

Polypropylene seat and back, fixed seat pad in upholstered polyurethane foam, frame made from Ø16mm steel tube, polypropylene glides.

Assise et dossier en polypropylène, assise rembourrée en polyuréthane expansée; structure en tube d'acier Ø16mm; patins en polypropylène.

Sitz und Rückenlehne aus Polypropylen; Sitzpolster aus Polyurethanschaum; Rahmen aus Stahlrohr Ø16mm; Füße aus Polypropylen.

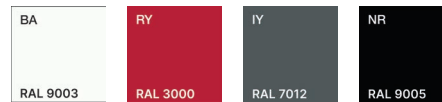

1 box
2 u. x box
0,330 M³

11,40
14,40

Depending on the surface the color may vary slightly from the reference (RAL / NCS) provided.
En fonction de la surface, la couleur peut varier légèrement par rapport à la référence (RAL / NCS) fournie.
Je nach Oberfläche kann die Farbe in Bezug auf die RAL/NCS Referenz abweichen.

UPHOLSTERY / REVETEMENT / BEZUG

B01/B03	C01/C05	D02/D05	E01
201 PTS	214 PTS	223 PTS	251 PTS

UPHOLSTERY ON REQUEST / REVETEMENT SUR REQUETE / ÜBERZUG AUF ANFRAGE

D06
223 PTS

FRAME / CADRE / GESTELL

	Chrome frame Cadre chromé Verchromtes Gestell	FSC27	=
	Powder coated frame in white Cadre verni blanc Gestell Weiß lackiert	FSB27	=
	Powder coated frame in black Cadre verni noir Gestell schwarz lackiert	FSN27	=

ACCESSORIES / ACCESSOIRES / ZUBEHÖR

	Set of silent anti-scratch felt pads and glides Kit de patins de feutres et patins anti-rayures et anti-bruit Kit kratzfesten und geräuschkämpfenden Filzgleiter.	ACC12	+19 PTS
	Mobile trolley (up to 10 chairs) Chariot de transport (capacité 10 chaises) Transportwagen (für bis zu 10 Stühle)	3OACC17	+546 PTS

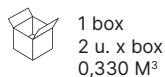
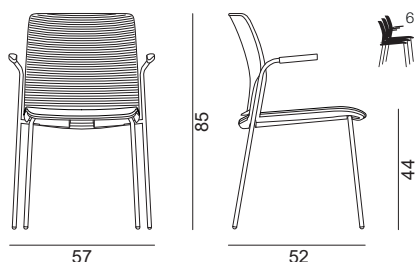

1 box
2 u. x box
0,330 M³



12,40
15,40

Cod. OCLOSV13

Polypropylene seat and back, matching polypropylene arms, fixed seat pad in upholstered polyurethane foam, frame made from Ø16mm steel tube, polypropylene glides.

Assise et dossier en polypropylène, assise rembourré en polyuréthane expansée; accoudoirs en polypropylène en teinte; structure en tube d'acier Ø16mm; patins en polypropylène.

Sitz und Rückenlehne aus Polypropylen; Sitzpolster aus Polyurethanschaum; Armlehnen aus Polypropylen farblich abgestimmt; Gestell aus Stahlrohr Ø16 mm; Füße aus Polypropylen.

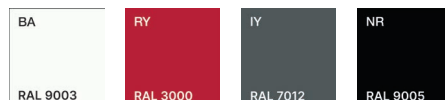

Depending on the surface the color may vary slightly from the reference (RAL / NCS) provided.
En fonction de la surface, la couleur peut varier légèrement par rapport à la référence (RAL / NCS) fournie.
Je nach Oberfläche kann die Farbe in Bezug auf die RAL/NCS Referenz abweichen.

UPHOLSTERY / REVETEMENT / BEZUG

B01/B03	C01/C05	D02/D05	E01
239 PTS	252 PTS	261 PTS	289 PTS

UPHOLSTERY ON REQUEST / REVETEMENT SUR REQUETE / ÜBERZUG AUF ANFRAGE

D06
261 PTS

FRAME / CADRE / GESTELL

	Chrome frame Cadre chromé Verchromtes Gestell	FSC28	=
	Powder coated frame in white Cadre verni blanc Gestell Weiß lackiert	FSB28	=
	Powder coated frame in black Cadre verni noir Gestell schwarz lackiert	FSN28	=

ACCESSORIES / ACCESSOIRES / ZUBEHÖR

	Set of silent anti-scratch felt pads and glides Kit de patins de feutres et patins anti-rayures et anti-bruit Kit kratzfesten und geräuschkämpfenden Filzgleiter.	ACC12	+19 PTS
	Mobile trolley (up to 10 chairs) Chariot de transport (capacité 10 chaises) Transportwagen (für bis zu 10 Stühle)	3OACC17	+546 PTS

Close polypropylene chair, upholstered seat, sled base in metal
 Chaise Close polypropylène, assise tapissée, luge métal
 Close Polypropylen-Stuhl, gepolsterter Sitz, Kufengestell aus Metall

CLOSE

PADDED SEAT
 ASSISE TAPISSÉE
 GEPOLSTERTER SITZ

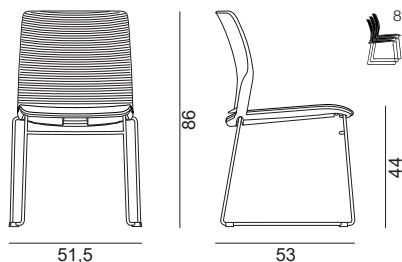

Cod. OCLOS12

Polypropylene seat and back, fixed seat pad in upholstered polyurethane foam, frame made from Ø11mm steel rod, polypropylene glides.

Assise et dossier en polypropylène, assise rembourrée en polyuréthane expansée; structure en tube d'acier Ø11mm; patins en polypropylène.

Sitz und Rückenlehne aus Polypropylen; Sitzpolsterung aus Polyurethanschaum; Gestell aus Stahlrohr Ø11mm; FüÙe aus Polypropylen.

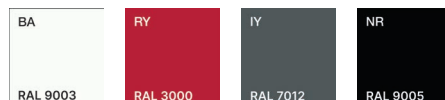

1 box
 2 u. x box
 0,330 M³

14,20
 17,20

Depending on the surface the color may vary slightly from the reference (RAL / NCS) provided.
 En fonction de la surface, la couleur peut varier légèrement par rapport à la référence (RAL / NCS) fournie.
 Je nach Oberfläche kann die Farbe in Bezug auf die RAL/NCS Referenz abweichen.

CATAS EN 16139 Level 1

UPHOLSTERY / REVETEMENT / BEZUG

B01/B03	C01/C05	D02/D05	E01
216 PTS	224 PTS	239 PTS	267 PTS



UPHOLSTERY ON REQUEST / REVETEMENT SUR REQUETE / ÜBERZUG AUF ANFRAGE

D06
239 PTS

FRAME / CADRE / GESTELL

	Chrome frame Cadre chromé Verchromtes Gestell	FSC29	=
--	--	--------------	---

ACCESSORIES / ACCESSOIRES / ZUBEHÖR

	Removable RH writing tablet Tablette écriitoare à droite amovible Rechter klappbare und abnehmbare Tisch	TAV16	+93 PTS
	Linking device Accrochage pour chaises Verbinder für Stühle	3OACC16	+20 PTS
	Mobile trolley (up to 10 chairs) Chariot de transport (capacité 10 chaises) Transportwagen (für bis zu 10 Stühle)	3OACC17	+546 PTS

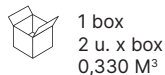
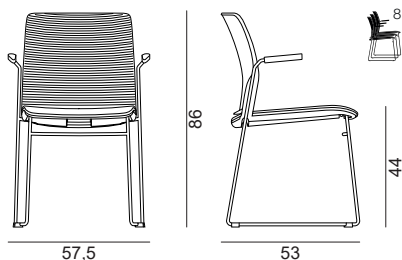

Cod. OCLOSV14

Polypropylene seat and back, matching polypropylene arms, fixed seat pad in upholstered polyurethane foam, frame made from Ø11mm steel rod, polypropylene glides.

Assise et dossier en polypropylène, assise rembourrée en polyuréthane expansée; accoudoirs en polypropylène en teinte; structure en tube d'acier Ø11mm; patins en polypropylène.

Sitz und Rückenlehne aus Polypropylen; Sitzpolster aus Polyurethanschaum; Armlehnen aus Polypropylen farblich abgestimmt; Gestell aus Stahlrohr Ø11 mm; Füße aus Polypropylen.

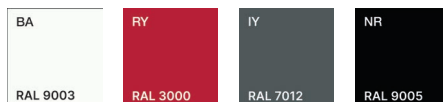

Depending on the surface the color may vary slightly from the reference (RAL / NCS) provided.
En fonction de la surface, la couleur peut varier légèrement par rapport à la référence (RAL / NCS) fournie.
Je nach Oberfläche kann die Farbe in Bezug auf die RAL/NCS Referenz abweichen.



UPHOLSTERY / REVETEMENT / BEZUG

B01/B03	C01/C05	D02/D05	E01
268 PTS	282 PTS	292 PTS	319 PTS



UPHOLSTERY ON REQUEST / REVETEMENT SUR REQUETE / ÜBERZUG AUF ANFRAGE

D06
292 PTS

FRAME / CADRE / GESTELL

	Chrome frame with integral arms Cadre chromé avec accoudoirs Verchromtes Gestell mit Armlehnen	FSC30	=
---	---	-------	---

ACCESSORIES / ACCESSOIRES / ZUBEHÖR

	Linking device Accrochage pour chaises Verbinder für Stühle	30ACC16	+20 PTS
	Mobile trolley (up to 10 chairs) Chariot de transport (capacité 10 chaises) Transportwagen (für bis zu 10 Stühle)	30ACC17	+546 PTS

Close polypropylene stool, upholstered seat, sled base, 750mm high seat
Tabouret Close polypropylène, assise tapissée, luge métal, H 75
Close Barhocker aus Polypropylen, gepolsterter Sitz, Metallkufen, H 75 cm

CLOSE

PADDED SEAT
 ASSISE TAPISSÉE
 GEPOLSTERTER SITZ

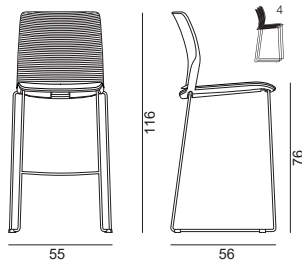

Cod. OCLOSS11

Polypropylene seat and back, fixed seat pad in upholstered polyurethane foam, frame made from Ø12mm steel rod, includes footrest, polypropylene glides.

Assise et dossier en polypropylène, assise rembourré en polyuréthane expansée; structure en tube d'acier Ø12mm; patins en polypropylène.

Sitz und Rückenlehne aus Polypropylen; Sitzpolsterung aus Polyurethanschaum; Gestell aus Stahlrohr Ø12mm mit Fußstütze; Füße aus Polypropylen.

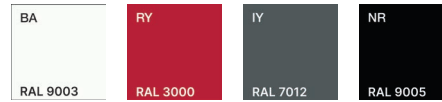

1 box
 2 u. x box
 0,420 M³

KG 17,20
 20,20

Depending on the surface the color may vary slightly from the reference (RAL / NCS) provided.
 En fonction de la surface, la couleur peut varier légèrement par rapport à la référence (RAL / NCS) fournie.
 Je nach Oberfläche kann die Farbe in Bezug auf die RAL/NCS Referenz abweichen.

UPHOLSTERY / REVETEMENT / BEZUG

B01/B03	C01/C05	D02/D05	E01
283 PTS	297 PTS	305 PTS	334 PTS

UPHOLSTERY ON REQUEST / REVETEMENT SUR REQUETE / ÜBERZUG AUF ANFRAGE

D06
305 PTS

FRAME / CADRE / GESTELL



Chrome frame
 Cadre chromé
 Verchromtes Gestell

FSC31

=

CLOSE

FULL POLYPROPYLENE SHELL
COQUE EN POLYPROPYLÈNE
SCHALE AUS POLYPROPYLEN

Close polypropylene beam seating, 2-seater Poutre Close polypropylène, 2 places Close Polypropylen-Bank, 2 Sitze

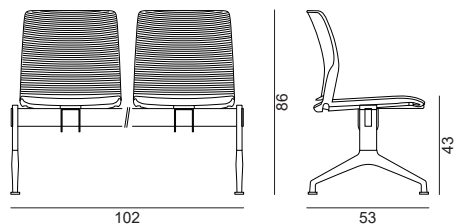

Cod. OCLOS201

Polypropylene seat and back, beam made from 80×40mm steel tube powder coated in black, legs made from die-cast aluminium in a polished aluminium finish.

Assise et dossier en polypropylène, poutre en tube d'acier 80×40mm verni noir; pieds en aluminium moulé sous pression poli.

Sitz und Rückenlehne aus Polypropylen; Traverse aus schwarz lackiertem Stahlrohr 80×40mm; Füße aus poliertem Aluminiumdruckguss.

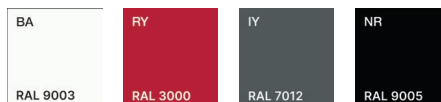

2 box
1 u. x box
0,175 M³



15,50
18,50

Depending on the surface the color may vary slightly from the reference (RAL / NCS) provided.
En fonction de la surface, la couleur peut varier légèrement par rapport à la référence (RAL / NCS) fournie.
Je nach Oberfläche kann die Farbe in Bezug auf die RAL/NCS Referenz abweichen.

FINISH OPTIONS / FINITION / AUSFÜHRUNG

BA	RS	GR	NR
517 PTS	517 PTS	517 PTS	517 PTS

ACCESSORIES / ACCESSOIRES / ZUBEHÖR



Black MFC table
Table noire en mélamine
Couchtisch aus schwarzem Melamin

Takes the place of one seat / Chaque tablette remplace une assise / Jede Tischplatte ersetzt einen Sitzplatz

TAV17

-22 PTS

ON REQUEST ONLY / SUR REQUETE / AUF ANFRAGE



Fire retardant shell in black
Version non-feu, coques en noir
Feuerfeste Ausführung, schwarze Schalen

Production lead time on request / Délai de fabrication sur requête / Lieferzeit auf Anfrage

IGNI

+105 PTS

Close polypropylene beam seating, 3-seater

Poutre Close polypropylène, 3 places

Close Polypropylen-Bank, 3 Sitze

CLOSE

FULL POLYPROPYLENE SHELL
COQUE EN POLYPROPYLENE
SCHALE AUS POLYPROPYLEN

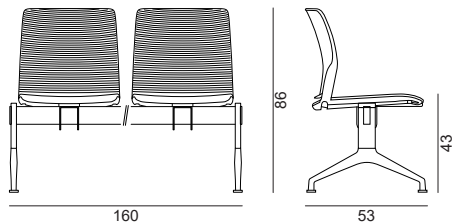



Cod. OCLOS301

Polypropylene seat and back, beam made from 80×40mm steel tube powder coated in black, legs made from die-cast aluminium in a polished aluminium finish.

Assise et dossier en polypropylène, poutre en tube d'acier 80×40mm verni noir; pieds en aluminium moulé sous pression poli.

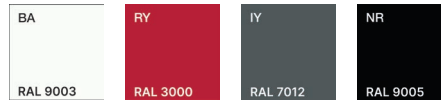
Sitz und Rückenlehne aus Polypropylen; Traverse aus schwarz lackiertem Stahlrohr 80×40mm; Füße aus poliertem Aluminiumdruckguss.



 2 box
1 u. x box
0,175 M³

 20,50
23,50

Depending on the surface the color may vary slightly from the reference (RAL / NCS) provided.
En fonction de la surface, la couleur peut varier légèrement par rapport à la référence (RAL / NCS) fournie.
Je nach Oberfläche kann die Farbe in Bezug auf die RAL/NCS Referenz abweichen.

FINISH OPTIONS / FINITION / AUSFÜHRUNG

BA	RS	GR	NR
675 PTS	675 PTS	675 PTS	675 PTS

ACCESSORIES / ACCESSOIRES / ZUBEHÖR



Black MFC table

Table noire en mélamine
Couchtisch aus schwarzem Melamin

Takes the place of one seat / Chaque tablette remplace une assise / Jede Tischplatte ersetzt einen Sitzplatz

TAV17

-22 PTS

ON REQUEST ONLY / SUR REQUETE / AUF ANFRAGE



Fire retardant shell in black

Version non-feu, coques en noir
Feuerfeste Ausführung, schwarze Schalen

Production lead time on request / Délai de fabrication sur requête / Lieferzeit auf Anfrage

IGNI

+157 PTS

CLOSE

FULL POLYPROPYLENE SHELL
COQUE EN POLYPROPYLÈNE
SCHALE AUS POLYPROPYLEN

Close polypropylene beam seating, 4-seater Poutre Close polypropylène, 4 places Close Polypropylen-Bank, 4 Sitze

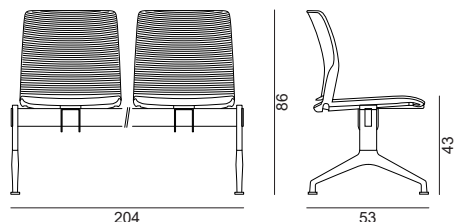

Cod. OCLOS401

Polypropylene seat and back, beam made from 80×40mm steel tube powder coated in black, legs made from die-cast aluminium in a polished aluminium finish.

Assise et dossier en polypropylène, poutre en tube d'acier 80×40mm verni noir; pieds en aluminium moulé sous pression poli.

Sitz und Rückenlehne aus Polypropylen; Traverse aus schwarz lackiertem Stahlrohr 80×40mm; Füße aus poliertem Aluminiumdruckguss.

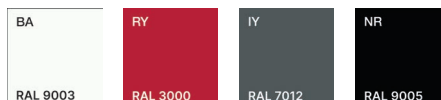

2 box
1 u. x box
0,175 M³



25,60
28,60

Depending on the surface the color may vary slightly from the reference (RAL / NCS) provided.
En fonction de la surface, la couleur peut varier légèrement par rapport à la référence (RAL / NCS) fournie.
Je nach Oberfläche kann die Farbe in Bezug auf die RAL/NCS Referenz abweichen.

FINISH OPTIONS / FINITION / AUSFÜHRUNG

BA	RS	GR	NR
837 PTS	837 PTS	837 PTS	837 PTS

ACCESSORIES / ACCESSOIRES / ZUBEHÖR



Black MFC table
Table noire en mélamine
Couchtisch aus schwarzem Melamin

Takes the place of one seat / Chaque tablette remplace une assise / Jede Tischplatte ersetzt einen Sitzplatz

TAV17

-22 PTS

ON REQUEST ONLY / SUR REQUETE / AUF ANFRAGE



Fire retardant shell in black
Version non-feu, coques en noir
Feuerfeste Ausführung, schwarze Schalen

Production lead time on request / Délai de fabrication sur requête / Lieferzeit auf Anfrage

IGNI

+210 PTS

Close polypropylene beam seating, 5-seater

Poutre Close polypropylène, 5 places

Close Polypropylen-Bank, 5 Sitze

CLOSE

FULL POLYPROPYLENE SHELL
COQUE EN POLYPROPYLENE
SCHALE AUS POLYPROPYLEN

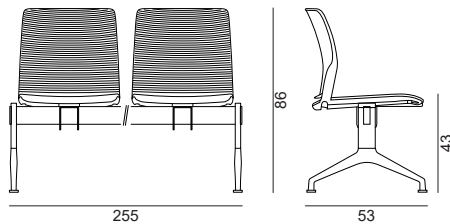



Cod. OCLOS501

Polypropylene seat and back, beam made from 80×40mm steel tube powder coated in black, legs made from die-cast aluminium in a polished aluminium finish.

Assise et dossier en polypropylène, poutre en tube d'acier 80×40mm verni noir; pieds en aluminium moulé sous pression poli.

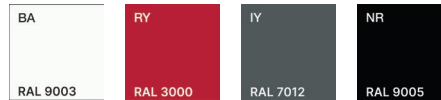
Sitz und Rückenlehne aus Polypropylen; Traverse aus schwarz lackiertem Stahlrohr 80×40mm; Füße aus poliertem Aluminiumdruckguss.



 2 box
1 u. x box
0,175 M³

 33,30
36,30

Depending on the surface the color may vary slightly from the reference (RAL / NCS) provided.
En fonction de la surface, la couleur peut varier légèrement par rapport à la référence (RAL / NCS) fournie.
Je nach Oberfläche kann die Farbe in Bezug auf die RAL/NCS Referenz abweichen.

FINISH OPTIONS / FINITION / AUSFÜHRUNG

BA	RS	GR	NR
1075 PTS	1075 PTS	1075 PTS	1075 PTS

ACCESSORIES / ACCESSOIRES / ZUBEHÖR



Black MFC table

Table noire en mélamine
Couchtisch aus schwarzem Melamin

Takes the place of one seat / Chaque tablette remplace une assise / Jede Tischplatte ersetzt einen Sitzplatz

TAV17

-22 PTS

ON REQUEST ONLY / SUR REQUETE / AUF ANFRAGE



Fire retardant shell in black

Version non-feu, coques en noir
Feuerfeste Ausführung, schwarze Schalen

Production lead time on request / Délai de fabrication sur requête / Lieferzeit auf Anfrage

IGNI

+262 PTS

CLOSE

PADDED SEAT
ASSISE TAPISSÉE
GEPOLSTERTER SITZ

Close polypropylene beam seating, upholstered seat, 2-seater Poutre Close polypropylène, assise tapissée, 2 places Close Polypropylen-Bank, gepolsterter Sitz, 2 Sitze

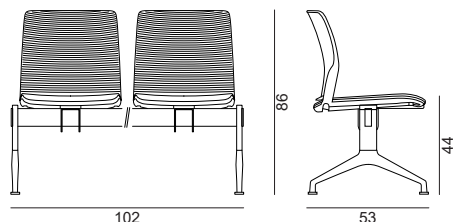

Cod. OCLOS202

Polypropylene seat and back, fixed seat pad in upholstered polyurethane foam, beam made from 80×40mm steel tube powder coated in black, legs made from die-cast aluminium in a polished aluminium finish.

Assise et dossier en polypropylène, assise rembourré en polyuréthane expansée; poutre en tube d'acier 80×4mm verni noir; pieds en aluminium moulé sous pression poli.

Sitz und Rückenlehne aus Polypropylen; Sitz- und Rückenlehnenpolster aus Polyurethanschäum; Traverse aus Stahlrohr 80×40mm schwarz lackiert; Füße aus poliertem Aluminiumdruckguss.



2 box
1 u. x box
0,175 M³



15,90
18,90

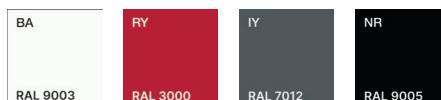

Depending on the surface the color may vary slightly from the reference (RAL / NCS) provided.

En fonction de la surface, la couleur peut varier légèrement par rapport à la référence (RAL / NCS) fournie.
Je nach Oberfläche kann die Farbe in Bezug auf die RAL/NCS Referenz abweichen.

UPHOLSTERY / REVETEMENT / BEZUG

B01/B03	C01/C05	D02/D05	E01
582 PTS	610 PTS	625 PTS	684 PTS

UPHOLSTERY ON REQUEST / REVETEMENT SUR REQUETE / ÜBERZUG AUF ANFRAGE

D06
625 PTS

ACCESSORIES / ACCESSOIRES / ZUBEHÖR



Black MFC table
Table noire en mélamine
Couchtisch aus schwarzem Melamin

Takes the place of one seat / Chaque tablette remplace une assise / Jede Tischplatte ersetzt einen Sitzplatz

TAV17

-22 PTS

Close polypropylene beam seating, upholstered seat, 3-seater

Poutre Close polypropylène, assise tapissée, 3 places

Close Polypropylen-Bank, gepolsterter Sitz, 3 Sitze

CLOSE

PADDED SEAT
ASSISE TAPISSÉE
GEPOLSTERTER SITZ

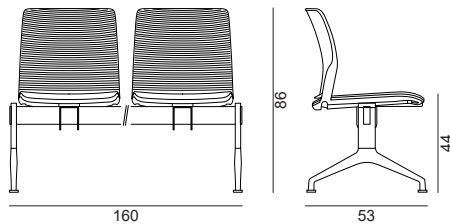



Cod. OCLOS302

Polypropylene seat and back, fixed seat pad in upholstered polyurethane foam, beam made from 80×40mm steel tube powder coated in black, legs made from die-cast aluminium in a polished aluminium finish.

Assise et dossier en polypropylène, assise rembourré en polyuréthane expansée; poutre en tube d'acier 80×4mm verni noir; pieds en aluminium moulé sous pression poli.

Sitz und Rückenlehne aus Polypropylen; Sitz- und Rückenlehnenpolster aus Polyurethanschaum; Traverse aus Stahlrohr 80×40mm schwarz lackiert; Füße aus poliertem Aluminiumdruckguss.

 2 box
1 u. x box
0,175 M³

 21,10
24,10



Depending on the surface the color may vary slightly from the reference (RAL / NCS) provided.

En fonction de la surface, la couleur peut varier légèrement par rapport à la référence (RAL / NCS) fournie.

Je nach Oberfläche kann die Farbe in Bezug auf die RAL/NCS Referenz abweichen.

UPHOLSTERY / REVETEMENT / BEZUG

B01/B03	C01/C05	D02/D05	E01
772 PTS	814 PTS	837 PTS	923 PTS

UPHOLSTERY ON REQUEST / REVETEMENT SUR REQUETE / ÜBERZUG AUF ANFRAGE

D06
837 PTS

ACCESSORIES / ACCESSOIRES / ZUBEHÖR



Black MFC table

Table noire en mélamine

Couchtisch aus schwarzem Melamin

Takes the place of one seat / Chaque tablette remplace une assise / Jede Tischplatte ersetzt einen Sitzplatz

TAV17

-22 PTS

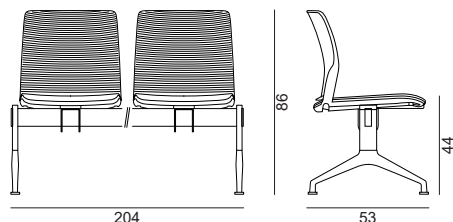

Cod. OCLOS402

Polypropylene seat and back, fixed seat pad in upholstered polyurethane foam, beam made from 80×40mm steel tube powder coated in black, legs made from die-cast aluminium in a polished aluminium finish.

Assise et dossier en polypropylène, assise rembourré en polyuréthane expansée; poutre en tube d'acier 80×4mm verni noir; pieds en aluminium moulé sous pression poli.

Sitz und Rückenlehne aus Polypropylen; Sitz- und Rückenlehnenpolster aus Polyurethanschaum; Traverse aus Stahlrohr 80×40mm schwarz lackiert; Füße aus poliertem Aluminiumdruckguss.



2 box
1 u. x box
0,175 M³



26,40
29,40

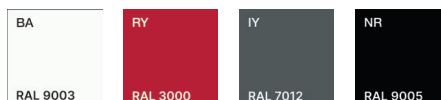

Depending on the surface the color may vary slightly from the reference (RAL / NCS) provided.

En fonction de la surface, la couleur peut varier légèrement par rapport à la référence (RAL / NCS) fournie.

Je nach Oberfläche kann die Farbe in Bezug auf die RAL/NCS Referenz abweichen.

UPHOLSTERY / REVETEMENT / BEZUG

B01/B03	C01/C05	D02/D05	E01
967 PTS	1022 PTS	1056 PTS	1168 PTS

UPHOLSTERY ON REQUEST / REVETEMENT SUR REQUETE / ÜBERZUG AUF ANFRAGE

D06
1056 PTS

ACCESSORIES / ACCESSOIRES / ZUBEHÖR



Black MFC table
Table noire en mélamine
Couchtisch aus schwarzem Melamin

Takes the place of one seat / Chaque tablette remplace une assise / Jede Tischplatte ersetzt einen Sitzplatz

TAV17

-22 PTS

Close polypropylene beam seating, upholstered seat, 5-seater

Poutre Close polypropylène, assise tapissée, 5 places

Close Polypropylen-Bank, gepolsterter Sitz, 5 Sitze

CLOSE

PADDED SEAT
ASSISE TAPISSÉE
GEPOLSTERTER SITZ

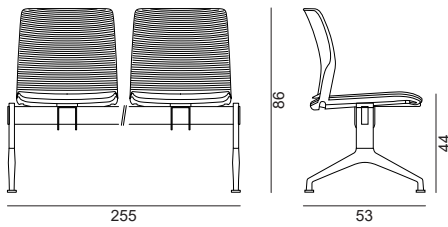



Cod. OCLOS502

Polypropylene seat and back, fixed seat pad in upholstered polyurethane foam, beam made from 80×40mm steel tube powder coated in black, legs made from die-cast aluminium in a polished aluminium finish.

Assise et dossier en polypropylène, assise rembourré en polyuréthane expansée; poutre en tube d'acier 80×4mm verni noir; pieds en aluminium moulé sous pression poli.

Sitz und Rückenlehne aus Polypropylen; Sitz- und Rückenlehnenpolster aus Polyurethanschaum; Traverse aus Stahlrohr 80×40mm schwarz lackiert; Füße aus poliertem Aluminiumdruckguss.

 2 box
1 u. x box
0,175 M³

 34,30
37,30

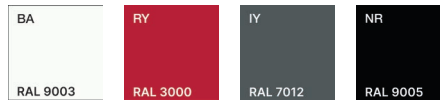

Depending on the surface the color may vary slightly from the reference (RAL / NCS) provided.

En fonction de la surface, la couleur peut varier légèrement par rapport à la référence (RAL / NCS) fournie.

Je nach Oberfläche kann die Farbe in Bezug auf die RAL/NCS Referenz abweichen.

UPHOLSTERY / REVETEMENT / BEZUG

B01/B03	C01/C05	D02/D05	E01
1239 PTS	1307 PTS	1349 PTS	1400 PTS

UPHOLSTERY ON REQUEST / REVETEMENT SUR REQUETE / ÜBERZUG AUF ANFRAGE

D06
1349 PTS

ACCESSORIES / ACCESSOIRES / ZUBEHÖR



Black MFC table

Table noire en mélamine

Couchtisch aus schwarzem Melamin

Takes the place of one seat / Chaque tablette remplace une assise / Jede Tischplatte ersetzt einen Sitzplatz

TAV17

-22 PTS

CLEOPAS

Cleopas armchair headrest Chauffeuse Cleopas avec appuis-tête Armsessel Cleopas Kopfstütze

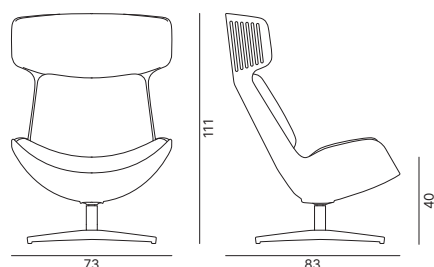



Cod. OCLEOP01

Visible shell in 8mm fibreglass reinforced nylon; seat and inner back in regenerated polypropylene; high-elasticity slab polyurethane foam padding wrapped in polyester fibre wadding; lift with standard auto-return mechanism; possibility of base and lift to match the shell.

Coque en vue en nylon renforcé de fibres de verre, épaisseur 8 mm; assise et dossier interne en polypropylène régénéré; rembourrage en mousse de polyuréthane à haute élasticité et résine ouatée; vérin avec système de retour automatique à point fixe en standard; possibilité d'avoir la base et le vérin dans la couleur de la coque.

Sichtbare Sitzschale aus mit Glasfaser verstärktem Nylon Stärke 8mm; Sitz und interne Rückenlehne aus rekonditioniertem Polypropylen; Polsterung aus hochelastischem Polyurethanschaum und Wattierungsharz; Drehlift mit serienmäßiger automatischer Rückstellung; Sockel und Drehlift in gleicher Farbe wie die Sitzschale möglich.

 1 box
1 u. x box
0,750 M³

 22,00
27,50

 Upholstery in fire retardant foam



UPHOLSTERY / REVETEMENT / BEZUG

B03	D02/D03	P01
2848 PTS	2951 PTS	3424 PTS



UPHOLSTERY ON REQUEST / REVETEMENT SUR REQUETE / ÜBERZUG AUF ANFRAGE

D04	E02/E03/E04	I01	M01/M02/M03
2951 PTS	3056 PTS	3326 PTS	3468 PTS

SHELL AND BASE / COQUE ET BASE / SITZSCHALE UND SOCKEL

	White Blanc Weiss	BA	=
	Umbra grey Gris ombre Umbragrau	GO	=
	Bronze	RN	+360 PTS

MECHANISM / MECANISME / MECHANISMUS

	Fixed plate Plaque fixe Feste metallplatte	MEC30	=
	Tilting mechanism Mécanisme basculant Wippmechanik	MEC27	+32 PTS

ACCESSORIES / ACCESSOIRES / ZUBEHÖR

	Swivel metal side table in a matching finish to the base Table en métal en teinte avec la base Tisch aus Metall in gleicher Farbe wie der Sockel	TAV19	+525 PTS
---	--	-------	----------

Cleopas armchair headrest
 Chauffeuse Cleopas avec appuis-tête
 Armsessel Cleopas Kopfstütze

ACCESSORIES / ACCESSOIRES / ZUBEHÖR		
	Felt pads Patins de feutre <i>Filzgleiter</i>	ACC14 +2 PTS
ON REQUEST ONLY / SUR REQUETE / AUF ANFRAGE		
	Powder coated shell and base in a special finish Peinture coque et base personnalisée <i>Lackierung Sitzschale und Sockel nach Kundenwunsch</i>	VERN +265 PTS
<small>Price on request for special varnish finishes / Pour vernis spécifiques, devis sur requête / Sonderlackfarben auf Anfrage</small>		
	Powder coated side table in a special finish Peinture table personnalisée <i>Lackierung Tisch nach Kundenwunsch</i> <small>Always matching with customed shell and base / Toujours assorti avec le corps et la base personnalisés / Immer gleiche Ausführung wie Schale und Gestell</small>	VERN +64 PTS

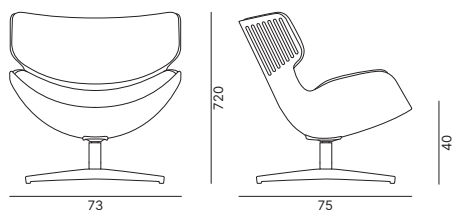

Cod. OCLEOB01

Visible shell in 8mm fibreglass reinforced nylon; seat and inner back in regenerated polypropylene; high-elasticity slab polyurethane foam padding wrapped in polyester fibre wadding; lift with standard auto-return mechanism; possibility of base and lift to match the shell.

Coque en vue en nylon renforcé de fibres de verre, épaisseur 8 mm; assise et dossier interne en polypropylène régénéré; rembourrage en mousse de polyuréthane à haute élasticité et résine ouatée; vérin avec système de retour automatique à point fixe en standard; possibilité d'avoir la base et le vérin dans la couleur de la coque.

Sichtbare Sitzschale aus mit Glasfaser verstärktem Nylon Stärke 8mm; Sitz und interne Rückenlehne aus rekonditioniertem Polypropylen; Polsterung aus hochelastischem Polyurethanschaum und Wattierungsharz; Drehlift mit serienmäßiger automatischer Rückstellung; Sockel und Drehlift in gleicher Farbe wie die Sitzschale möglich.

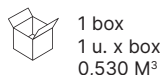

1 box
1 u. x box
0,530 M³



19,50
25,00



Upholstery in fire retardant foam



UPHOLSTERY / REVETEMENT / BEZUG

B03	D02/D03	P01
2471 PTS	2544 PTS	2870 PTS



UPHOLSTERY ON REQUEST / REVETEMENT SUR REQUETE / ÜBERZUG AUF ANFRAGE

D04	E02/E03/E04	I01	M01/M02/M03
2544 PTS	2618 PTS	2810 PTS	2910 PTS

SHELL AND BASE / COQUE ET BASE / SITZSCHALE UND SOCKEL

	White Blanc Weiss	BA	=
	Umbra grey Gris ombre Umbragrau	GO	=
	Bronze	RN	+360 PTS



MECHANISM / MECANISME / MECHANISMUS

	Fixed plate Plaque fixe Feste metallplatte	MEC30	=
	Tilting mechanism Mécanisme basculant Wippmechanik	MEC27	+32 PTS

ACCESSORIES / ACCESSOIRES / ZUBEHÖR

	Swivel metal side table in a matching finish to the base Table en métal en teinte avec la base Tisch aus Metall in gleicher Farbe wie der Sockel	TAV19	+525 PTS
---	--	-------	----------

Low Cleopas armchair
 Chauffeuse Cleopas basse
 Armsessel Cleopas niedrig

ACCESSORIES / ACCESSOIRES / ZUBEHÖR			
	Felt pads Patins de feutre Filzgleiter	ACC14	+2 PTS
ON REQUEST ONLY / SUR REQUETE / AUF ANFRAGE			
	Powder coated shell and base in a special finish Peinture coque et base personnalisée Lackierung Sitzschale und Sockel nach Kundenwunsch <small>Price on request for special varnish finishes / Pour vernis spécifiques, devis sur requête / Sonderlackfarben auf Anfrage</small>	VERN	+212 PTS
	Powder coated side table in a special finish Peinture table personnalisée Lackierung Tisch nach Kundenwunsch <small>Always matching with customed shell and base / Toujours assorti avec le corps et la base personnalisés / Immer gleiche Ausführung wie Schale und Gestell</small>	VERN	+64 PTS

CLEOPAS

Cleopas armchair headrest, padded shell Chauffeuse Cleopas avec appuis-tête, coque rembourrée Armsessel Cleopas Kopfstütze, Sitzschale gepolstert

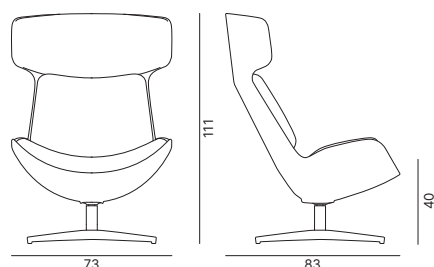

Cod. OCLEOP21

Shell in 8mm fibreglass reinforced nylon; seat and inner back in regenerated polypropylene; high-elasticity slab polyurethane foam padding wrapped in polyester fibre wadding; lift with standard auto-return mechanism; possibility of base and lift to match the shell.

Coque en nylon renforcé de fibres de verre, épaisseur 8 mm; assise et dossier interne en polypropylène régénéré; rembourrage en mousse de polyuréthane à haute élasticité et résine ouatée; vérin avec système de retour automatique à point fixe en standard; possibilité d'avoir la base et le vérin dans la couleur de la coque.

Sitzschale Nylon, mit Glasfaser verstärkt Stärke 8mm; Sitz und interne Rückenlehne aus rekonditioniertem Polypropylen; Polsterung aus hochelastischem Polyurethanschaum und Wattierungsharz; Drehlift mit serienmäßiger automatischer Rückstellung; Sockel und Drehlift in gleicher Farbe wie die Sitzschale möglich.



1 box
1 u. x box
0,750 M³



22,50
28,00



Upholstery in fire retardant foam

CUSHION UPHOLSTERY / REVETEMENT COUSSIN / KISSENBEZUG

B03	D02/D03	P01
2633 PTS	2723 PTS	3301 PTS

Full price: add prices of seat & back cushions upholstery + outer carcass upholstery + legs / Pour le prix total, il faut ajouter coussin, coque et base / Für den Gesamtpreis addieren Sie Sitzkissen, Sitz und Gestell

CUSHION UPHOLSTERY ON REQUEST / REVETEMENT COUSSIN SUR REQUETE / ÜBERZUG KISSEN AUF ANFRAGE

D04	E02/E03/E04	I01	M01/M02/M03
2723 PTS	2814 PTS	3052 PTS	3176 PTS

Full price: add prices of seat & back cushions upholstery + outer carcass upholstery + legs / Pour le prix total, il faut ajouter coussin, coque et base / Für den Gesamtpreis addieren Sie Sitzkissen, Sitz und Gestell

OUTER CARCASS UPHOLSTERY / REVETEMENT COQUE / SCHALENBEZUG

B03	D02/D03	P01
83 PTS	156 PTS	541 PTS

Full price: add prices of seat & back cushions upholstery + outer carcass upholstery + legs / Pour le prix total, il faut ajouter coussin, coque et base / Für den Gesamtpreis addieren Sie Sitzkissen, Sitz und Gestell

OUTER CARCASS UPHOLSTERY ON REQUEST / REVETEMENT COQUE SUR REQUETE / SCHALENBEZUG AUF ANFRAGE

D04	E02/E03	I01	M02/M03
156 PTS	230 PTS	422 PTS	522 PTS

Full price: add prices of seat & back cushions upholstery + outer carcass upholstery + legs / Pour le prix total, il faut ajouter coussin, coque et base / Für den Gesamtpreis addieren Sie Sitzkissen, Sitz und Gestell







BASE / BASE / GESTELL

	Powder coated aluminium spider base in anthracite Piètement 4 branches en alu verni gris ombre 4-Sternfußkreuz Dunkelgrau pulverbeschichtet	BAA27	=
	Powder coated aluminium 4-star base in white Piètement 4 branches en alu verni blanc 4-Sternfußkreuz Weiß pulverbeschichtet	BAA28	=

Cleopas armchair headrest, padded shell

Chaufeuse Cleopas avec appuis-tête, coque rembourrée

Armsessel Cleopas Kopfstütze, Sitzschale gepolstert

BASE / BASE / GESTELL			
	Powder coated aluminium spider base in bronze Piètement 4 branches en alu verni bronze 4-Sternfußkreuz Bronze pulverbeschichtet	BAA29	+42 PTS
MECHANISM / MECANISME / MECHANISMUS			
	Fixed plate Plaque fixe Feste metallplatte	MEC30	=
	Tilting mechanism Mécanisme basculant Wippmechanik	MEC27	+32 PTS
ACCESSORIES / ACCESSOIRES / ZUBEHÖR			
	Swivel metal side table in a matching finish to the base Table en métal en teinte avec la base Tisch aus Metall in gleicher Farbe wie der Sockel	TAV19	+525 PTS
	Felt pads Patins de feutre Filzgleiter	ACC14	+2 PTS
ON REQUEST ONLY / SUR REQUETE / AUF ANFRAGE			
	Powder coated base in a special finish Peinture base personnalisée Lackierung Sockel nach Kundenwunsch Price on request for special varnish finishes / Pour vernis spécifiques, devis sur requête / Sonderlackfarben auf Anfrage	VERN	+106 PTS
	Powder coated side table in a special finish Peinture table personnalisée Lackierung Tisch nach Kundenwunsch Always matching with customed shell and base / Toujours assorti avec le corps et la base personnalisés / Immer gleiche Ausführung wie Schale und Gestell	VERN	+64 PTS

CLEOPAS

Low Cleopas armchair, padded shell Chaufeuse Cleopas basse, coque rembourrée Armsessel Cleopas niedrig, Sitzschale gepolstert

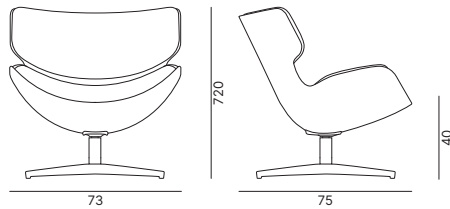

Cod. OCLEOB21

Shell in 8mm fibreglass reinforced nylon; seat and inner back in regenerated polypropylene; high-elasticity slab polyurethane foam padding wrapped in polyester fibre wadding; lift with standard auto-return mechanism; possibility of base and lift to match the shell.

Coque en nylon renforcé de fibres de verre, épaisseur 8 mm; assise et dossier interne en polypropylène régénéré; rembourrage en mousse de polyuréthane à haute élasticité et résine ouatée; vérin avec système de retour automatique à point fixe en standard; possibilité d'avoir la base et le vérin dans la couleur de la coque.

Sitzschale Nylon, mit Glasfaser verstärkt Stärke 8mm; Sitz und interne Rückenlehne aus rekonditioniertem Polypropylen; Polsterung aus hochelastischem Polyurethanschaum und Wattierungsharz; Drehlift mit serienmäßiger automatischer Rückstellung; Sockel und Drehlift in gleicher Farbe wie die Sitzschale möglich.

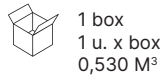

1 box
1 u. x box
0,530 M³



19,50
25,00



Upholstery in fire retardant foam

CUSHION UPHOLSTERY / REVETEMENT COUSSIN / KISSENBEZUG

B03	D02/D03	P01
2335 PTS	2392 PTS	2764 PTS

Full price: add prices of seat & back cushions upholstery + outer carcass upholstery + legs / Pour le prix total, il faut ajouter coussin, coque et base / Für den Gesamtpreis addieren Sie Sitzkissen, Sitz und Gestell

CUSHION UPHOLSTERY ON REQUEST / REVETEMENT COUSSIN SUR REQUETE / ÜBERZUG KISSEN AUF ANFRAGE

D04	E02/E03/E04	I01	M01/M02/M03
2392 PTS	2452 PTS	2604 PTS	2684 PTS

Full price: add prices of seat & back cushions upholstery + outer carcass upholstery + legs / Pour le prix total, il faut ajouter coussin, coque et base / Für den Gesamtpreis addieren Sie Sitzkissen, Sitz und Gestell

OUTER CARCASS UPHOLSTERY / REVETEMENT COQUE / SCHALENBEZUG

B03	D02/D03	P01
72 PTS	137 PTS	477 PTS

Full price: add prices of seat & back cushions upholstery + outer carcass upholstery + legs / Pour le prix total, il faut ajouter coussin, coque et base / Für den Gesamtpreis addieren Sie Sitzkissen, Sitz und Gestell

OUTER CARCASS UPHOLSTERY ON REQUEST / REVETEMENT COQUE SUR REQUETE / SCHALENBEZUG AUF ANFRAGE







D04	E02/E03	I01	M02/M03
137 PTS	201 PTS	371 PTS	459 PTS

Full price: add prices of seat & back cushions upholstery + outer carcass upholstery + legs / Pour le prix total, il faut ajouter coussin, coque et base / Für den Gesamtpreis addieren Sie Sitzkissen, Sitz und Gestell

BASE / BASE / GESTELL

	Powder coated aluminium spider base in anthracite Piètement 4 branches en alu verni gris ombre 4-Sternfußkreuz Dunkelgrau pulverbeschichtet	BAA27	=
	Powder coated aluminium 4-star base in white Piètement 4 branches en alu verni blanc 4-Sternfußkreuz Weiß pulverbeschichtet	BAA28	=

Low Cleopas armchair, padded shell Chaufeuse Cleopas basse, coque rembourrée Armsessel Cleopas niedrig, Sitzschale gepolstert

BASE / BASE / GESTELL			
	Powder coated aluminium spider base in bronze Piètement 4 branches en alu verni bronze 4-Sternfußkreuz Bronze pulverbeschichtet	BAA29	+42 PTS
MECHANISM / MECANISME / MECHANISMUS			
	Fixed plate Plaque fixe Feste metallplatte	MEC30	=
	Tilting mechanism Mécanisme basculant Wippmechanik	MEC27	+32 PTS
ACCESSORIES / ACCESSOIRES / ZUBEHÖR			
	Swivel metal side table in a matching finish to the base Table en métal en teinte avec la base Tisch aus Metall in gleicher Farbe wie der Sockel	TAV19	+525 PTS
	Felt pads Patins de feutre Filzgleiter	ACC14	+2 PTS
ON REQUEST ONLY / SUR REQUETE / AUF ANFRAGE			
	Powder coated base in a special finish Peinture base personnalisée Lackierung Sockel nach Kundenwunsch <small>Price on request for special varnish finishes / Pour vernis spécifiques, devis sur requête / Sonderlackfarben auf Anfrage</small>	VERN	+106 PTS
	Powder coated side table in a special finish Peinture table personnalisée Lackierung Tisch nach Kundenwunsch <small>Always matching with customed shell and base / Toujours assorti avec le corps et la base personnalisés / Immer gleiche Ausführung wie Schale und Gestell</small>	VERN	+64 PTS

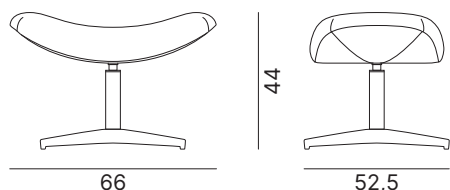

Cod. OCLEO001

Beech plywood frame; polyurethane foam padding; steel plate; possibility of base and lift to match the shell.

Structure en multi-plis de hêtre; rembourrage en polyuréthane expansé; plaque en acier; possibilité de base et rehausse en teinte avec la coque

Gestell aus mehrschichtigem Eschenholz; Polsterung aus Polyurethanschaum; Platte aus Stahl; Möglichkeit von Sockel und Drehlift in gleicher Farbe wie die Sitzschale.



Upholstery in fire retardant foam



1 box
 1 u. x box
 0,050 M³



6,00
 7,50

UPHOLSTERY / REVETEMENT / BEZUG

B03	D02/D03	P01
562 PTS	584 PTS	697 PTS

UPHOLSTERY ON REQUEST / REVETEMENT SUR REQUETE / ÜBERZUG AUF ANFRAGE

D04	E02/E03/E04	I01	M01/M02/M03
584 PTS	605 PTS	612 PTS	691 PTS

BASE / BASE / GESTELL

	Powder coated aluminium spider base in anthracite Piètement 4 branches en alu verni gris ombre 4-Sternfußkreuz Dunkelgrau pulverbeschichtet	BAA30	=
	Powder coated aluminium 4-star base in white Piètement 4 branches en alu verni blanc 4-Sternfußkreuz Weiß pulverbeschichtet	BAA31	=
	Powder coated aluminium spider base in bronze Piètement 4 branches en alu verni bronze 4-Sternfußkreuz Bronze pulverbeschichtet	BAA32	+42 PTS

ACCESSORIES / ACCESSOIRES / ZUBEHÖR

	Felt pads Patins de feutre Filzgleiter	ACC14	+2 PTS
--	---	--------------	--------

City lounge chair, high back with integral headrest, 4-star swivel base

Chaise City Lounge avec appui-tête, base pivotante 4 branches

City-Lounge mit Kopfstütze, 4-Sternen-Drehfuß

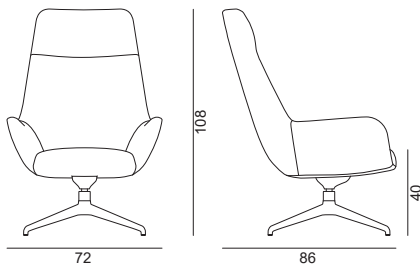

Cod. OCITYLP1

Monoshell with steel inner frame and injection moulded polyurethane foam; seat pad made from cut-to-size polyurethane foam sheet. Polished aluminium 4-star base; felt pads for wooden flooring included.

Coque en polyuréthane expansée à mousse avec structure en acier; assise en polyuréthane expansée sélectionnée d'un bloc. Piètement 4 branches en aluminium brillant; patins de feutres pour sols délicats inclus.

Sesselkörper aus kaltgeschäumtem Polyurethanschaum in Stahlrahmen; Sitz aus Polyurethanschaum. 4-Sternfußkreuz Alu poliert; Filzpolster für weichen Böden inklusive.



Upholstery in fire retardant foam



1 box
1 u. x box
0,530 M³



18,50
21,50



UPHOLSTERY / REVETEMENT / BEZUG

B01/B03	C01/C05	D02/D03	E01	P01
1143 PTS	1227 PTS	1266 PTS	1231 PTS	1534 PTS





UPHOLSTERY ON REQUEST / REVETEMENT SUR REQUETE / ÜBERZUG AUF ANFRAGE

D04/D06	E02/E03/E04	I01/I02	M01/M02/M03
1266 PTS	1231 PTS	1456 PTS	1573 PTS

BASE / BASE / GESTELL

	Polished aluminium 4-star base Piètement 4 branches en aluminium brillant 4-Sternfußkreuz Alu poliert	BAA24	=
	Powder coated aluminium 4-star base on glides, black finish Piètement 4 branches en aluminium verni noir mat 4-Sternfußkreuz matt schwarz lackiert	BAA25	=

MECHANISM / MECANISME / MECHANISMUS

	No mechanism Mécanisme base Grundmechanik ohne Bewegung For polished aluminium base / Pour base aluminium brillant / Für Sockel Aluminium glänzend	MEC24	=
	No mechanism Mécanisme base noir Schwarze Grundmechanik ohne Bewegung For black base / Pour base noire / Für Sockel schwarz	MEC26	=
	Tilting mechanism Mécanisme basculant Wippmechanik For polished aluminium base / Pour base aluminium brillant / Für Sockel Aluminium glänzend	MEC23	+33 PTS
	Multi-lock tilt black mechanism Mécanisme basculant noir Schwarze Wippmechanik For black base / Pour base noire / Für Sockel schwarz	MEC25	+33 PTS

CITY LOUNGE

City lounge chair, high back, 4-star swivel base Chaise City Lounge haute, base pivotante 4 branches City-Lounge hoch, 4-Sternen-Drehfuß

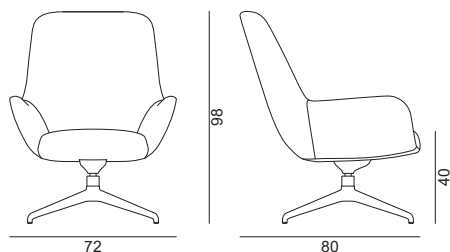

Cod. OCITYLA1

Monoshell with steel inner frame and injection moulded polyurethane foam; seat pad made from cut-to-size polyurethane foam sheet. Polished aluminium 4-star base; felt pads for wooden flooring included.

Coque en polyuréthane expansée à mousse avec structure en acier; assise en polyuréthane expansée sélectionnée d'un bloc. Piètement 4 branches en aluminium brillant; patins de feutres pour sols délicats inclus.

Sesselkörper aus kaltgeschäumtem Polyurethanschaum in Stahlrahmen; Sitz aus Polyurethanschaum. 4-Sternfußkreuz Alu poliert; Filzpolster für weichen Böden inklusive.

 Upholstery in fire retardant foam

 1 box
1 u. x box
0,530 M³

 17,00
20,00



UPHOLSTERY / REVETEMENT / BEZUG

B01/B03	C01/C05	D02/D03	E01	P01
1055 PTS	1121 PTS	1166 PTS	1207 PTS	1411 PTS





UPHOLSTERY ON REQUEST / REVETEMENT SUR REQUETE / ÜBERZUG AUF ANFRAGE

D04/D06	E02/E03/E04	I01/I02	M01/M02/M03
1166 PTS	1207 PTS	1407 PTS	1509 PTS

BASE / BASE / GESTELL

	Polished aluminium 4-star base Piètement 4 branches en aluminium brillant 4-Sternfußkreuz Alu poliert	BAA24	=
	Powder coated aluminium 4-star base on glides, black finish Piètement 4 branches en aluminium verni noir mat 4-Sternfußkreuz matt schwarz lackiert	BAA25	=

MECHANISM / MECANISME / MECHANISMUS

	No mechanism Mécanisme base Grundmechanik ohne Bewegung For polished aluminium base / Pour base aluminium brillant / Für Sockel Aluminium glänzend	MEC24	=
	No mechanism Mécanisme base noir Schwarze Grundmechanik ohne Bewegung For black base / Pour base noire / Für Sockel schwarz	MEC26	=
	Tilting mechanism Mécanisme basculant Wippmechanik For polished aluminium base / Pour base aluminium brillant / Für Sockel Aluminium glänzend	MEC23	+33 PTS
	Multi-lock tilt black mechanism Mécanisme basculant noir Schwarze Wippmechanik For black base / Pour base noire / Für Sockel schwarz	MEC25	+33 PTS

City lounge chair, mid back, 4-star swivel base

Chaufeuse City Lounge basse, base pivotante 4 branches

City-Lounge niedrig, 4-Sternen-Drehfuß

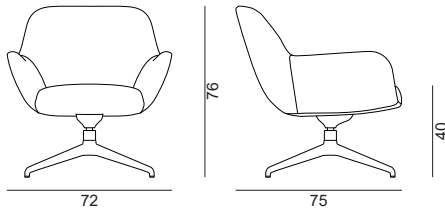

Cod. OCITYLB1

Monoshell with steel inner frame and injection moulded polyurethane foam; seat pad made from cut-to-size polyurethane foam sheet. Polished aluminium 4-star base; felt pads for wooden flooring included.

Coque en polyuréthane expansée à mousse avec structure en acier; assise en polyuréthane expansée sélectionnée d'un bloc. Piètement 4 branches en aluminium brillant; patins de feutres pour sols délicats inclus.

Sesselkörper aus kaltgeschäumtem Polyurethanschaum in Stahlrahmen; Sitz aus Polyurethanschaum. 4-Sternfußkreuz Alu poliert; Filzpolster für weichen Böden inklusive.



Upholstery in fire retardant foam

1 box
1 u. x box
0,530 M³

15,50
18,50

UPHOLSTERY / REVETEMENT / BEZUG

B01/B03	C01/C05	D02/D03	E01	P01
959 PTS	1021 PTS	1059 PTS	1102 PTS	1280 PTS

UPHOLSTERY ON REQUEST / REVETEMENT SUR REQUETE / ÜBERZUG AUF ANFRAGE

D04/D06	E02/E03/E04	I01/I02	M01/M02/M03
1059 PTS	1102 PTS	1289 PTS	1386 PTS

BASE / BASE / GESTELL

	Polished aluminium 4-star base Piètement 4 branches en aluminium brillant 4-Sternfußkreuz Alu poliert	BAA24	=
	Powder coated aluminium 4-star base on glides, black finish Piètement 4 branches en aluminium verni noir mat 4-Sternfußkreuz matt schwarz lackiert	BAA25	=

MECHANISM / MECANISME / MECHANISMUS

	No mechanism Mécanisme base Grundmechanik ohne Bewegung <small>For polished aluminium base / Pour base aluminium brillant / Für Sockel Aluminium glänzend</small>	MEC24	=
	No mechanism Mécanisme base noir Schwarze Grundmechanik ohne Bewegung <small>For black base / Pour base noire / Für Sockel schwarz</small>	MEC26	=
	Tilting mechanism Mécanisme basculant Wippmechanik <small>For polished aluminium base / Pour base aluminium brillant / Für Sockel Aluminium glänzend</small>	MEC23	+33 PTS
	Multi-lock tilt black mechanism Mécanisme basculant noir Schwarze Wippmechanik <small>For black base / Pour base noire / Für Sockel schwarz</small>	MEC25	+33 PTS

CITY LOUNGE

City lounge pouff, 4-star swivel base Pouf City Lounge, base pivotante 4 branches City-Lounge Barhocker, 4-Sternen-Drehfuß

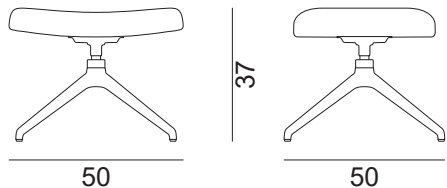

Cod. OCITYL01

Beech plywood inner frame, cut-to-size polyurethane foam sheet. Polished aluminium 4-star base; felt pads for wooden flooring included.

Assise interne en multi-plis de hêtre; rembourrage en polyuréthane expansée sélectionné par un bloc. Piètement 4 branches en aluminium brillant; patins de feutres pour sols délicats inclus.

Innensitz aus Buchensperrholz; Polsterung aus Polyurethanschaum. 4-Sternfußkreuz Alu poliert; Filzpolster für weichen Böden inklusive.



Upholstery in fire retardant foam



1 box
1 u. x box
0,170 M³



5,50
7,00

UPHOLSTERY / REVETEMENT / BEZUG

B01/B03	C01/C05	D02/D03	E01	P01
372 PTS	386 PTS	391 PTS	406 PTS	436 PTS

UPHOLSTERY ON REQUEST / REVETEMENT SUR REQUETE / ÜBERZUG AUF ANFRAGE

D04/D06	E02/E03/E04	I01/I02	M01/M02/M03
391 PTS	406 PTS	449 PTS	473 PTS

BASE / BASE / GESTELL



Polished aluminium 4-star base
Piètement 4 branches en aluminium brillant
4-Sternfußkreuz Alu poliert

BAA24

=



Powder coated aluminium 4-star base on glides, black finish
Piètement 4 branches en aluminium verni noir mat
4-Sternfußkreuz matt schwarz lackiert

BAA25

=

City lounge chair, high back with integral headrest, 4 déco legs

Chaufeuse City Lounge avec appui-tête, 4 pieds déco

City-Lounge mit Kopfstütze, 4 FüÙe déco

CITY LOUNGE

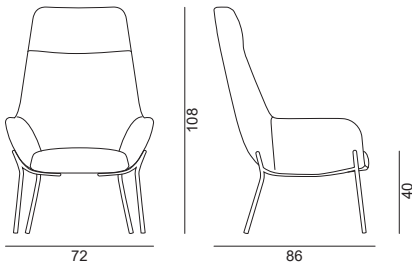



Cod. OCITYLP2

Steel inner frame; injection moulded polyurethane foam; seat pad made from cut-to-size polyurethane foam sheet. Frame in powder coated steel tube; adjustable polyethylene glides with felt pad or base for hard floors.

Coque en polyuréthane expansée à mousse avec structure en acier; assise en polyuréthane expansée sélectionnée d'un bloc. Cadre en tube d'acier verni; patins réglables en polyéthylène avec feutre ou avec base pour sols durs.

Sesselkörper aus kaltgeschäumtem Polyurethanschaum in Stahlrahmen; Sitz aus Polyurethanschaum. Gestell aus Stahlrohr lackiert; schwenkbare FüÙe aus Polyethylen mit Filz oder Sockel für harte Fußböden.

 1 box
1 u. x box
0,530 M³

 18,50
21,50

 Upholstery in fire retardant foam

UPHOLSTERY / REVETEMENT / BEZUG

B01/B03	C01/C05	D02/D03	E01	P01
1143 PTS	1227 PTS	1266 PTS	1231 PTS	1534 PTS



UPHOLSTERY ON REQUEST / REVETEMENT SUR REQUETE / ÜBERZUG AUF ANFRAGE

D04/D06	E02/E03/E04	I01/I02	M01/M02/M03
1266 PTS	1231 PTS	1456 PTS	1573 PTS

FRAME / CADRE / GESTELL

	Powder coated frame in anthracite Cadre verni gris ombre Gestell Dunkelgrau lackiert	FST32	=
--	---	-------	---

ON REQUEST ONLY / SUR REQUETE / AUF ANFRAGE

	Gold powder coated frame Structure vernie or Gestell Gold lackiert	OR	+131 PTS
	Bronze powder coated frame Structure vernie bronze Gestell Bronze lackiert	BR	+131 PTS
	Corten powder coated frame Structure vernie corten Gestell Corten lackiert	CO	+131 PTS

CITY LOUNGE

City lounge chair, high back, 4 déco legs
 Chauffeuse City Lounge haute, 4 pieds déco
 City-Lounge hoch, 4 FüÙe déco

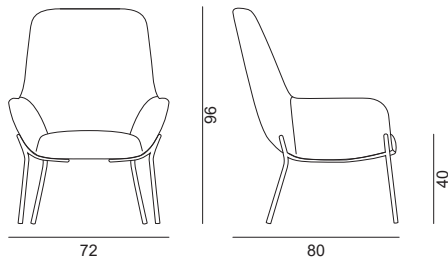

Cod. OCITYLA2

Steel inner frame; injection moulded polyurethane foam; seat pad made from cut-to-size polyurethane foam sheet. Frame in powder coated steel tube; adjustable polyethylene glides with felt pad or base for hard floors.

Coque en polyuréthane expansée à mousse avec structure en acier; assise en polyuréthane expansée sélectionnée d'un bloc. Cadre en tube d'acier verni; patins réglables en polyéthylène avec feutre ou avec base pour sols durs.

Sesselkörper aus kaltgeschäumtem Polyurethanschaum in Stahlrahmen; Sitz aus Polyurethanschaum. Gestell aus Stahlrohr lackiert; schwenkbare FüÙe aus Polyethylen mit Filz oder Sockel für harte Fußböden.

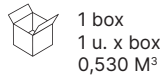

1 box
 1 u. x box
 0,530 M³



17,00
 20,00



Upholstery in fire retardant foam

UPHOLSTERY / REVETEMENT / BEZUG

B01/B03	C01/C05	D02/D03	E01	P01
1055 PTS	1121 PTS	1166 PTS	1207 PTS	1411 PTS



UPHOLSTERY ON REQUEST / REVETEMENT SUR REQUETE / ÜBERZUG AUF ANFRAGE

D04/D06	E02/E03/E04	I01/I02	M01/M02/M03
1166 PTS	1207 PTS	1407 PTS	1509 PTS

FRAME / CADRE / GESTELL

	Powder coated frame in anthracite Cadre verni gris ombre Gestell Dunkelgrau lackiert	FST32	=
---	---	--------------	---

ON REQUEST ONLY / SUR REQUETE / AUF ANFRAGE

	Gold powder coated frame Structure vernie or Gestell Gold lackiert	OR	+131 PTS
	Bronze powder coated frame Structure vernie bronze Gestell Bronze lackiert	BR	+131 PTS
	Corten powder coated frame Structure vernie corten Gestell Corten lackiert	CO	+131 PTS

City lounge chair, mid back, 4 déco legs
 Chauffeuse City Lounge basse, 4 pieds déco
 City-Lounge niedrig, 4 FüÙe déco

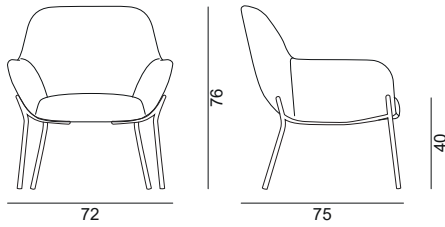

Cod. OCITYLB2

Steel inner frame; injection moulded polyurethane foam; seat pad made from cut-to-size polyurethane foam sheet. Frame in powder coated steel tube; adjustable polyethylene glides with felt pad or base for hard floors.

Coque en polyuréthane expansée à mousse avec structure en acier; assise en polyuréthane expansée sélectionnée d'un bloc. Cadre en tube d'acier verni; patins réglables en polyéthylène avec feutre ou avec base pour sols durs.

Sesselkörper aus kaltgeschäumtem Polyurethanschaum in Stahlrahmen; Sitz aus Polyurethanschaum. Gestell aus Stahlrohr lackiert; schwenkbare FüÙe aus Polyethylen mit Filz oder Sockel für harte Fußböden.

1 box
1 u. x box
0,530 M³

15,50
18,50

Upholstery in fire retardant foam

UPHOLSTERY / REVETEMENT / BEZUG

B01/B03	C01/C05	D02/D03	E01	P01
959 PTS	1021 PTS	1059 PTS	1102 PTS	1280 PTS

UPHOLSTERY ON REQUEST / REVETEMENT SUR REQUETE / ÜBERZUG AUF ANFRAGE

D04/D06	E02/E03/E04	I01/I02	M01/M02/M03
1059 PTS	1102 PTS	1289 PTS	1386 PTS

FRAME / CADRE / GESTELL

	Powder coated frame in anthracite Cadre verni gris ombre Gestell Dunkelgrau lackiert	FST32	=
--	---	-------	---

ON REQUEST ONLY / SUR REQUETE / AUF ANFRAGE

	Gold powder coated frame Structure vernie or Gestell Gold lackiert	OR	+131 PTS
	Bronze powder coated frame Structure vernie bronze Gestell Bronze lackiert	BR	+131 PTS
	Corten powder coated frame Structure vernie corten Gestell Corten lackiert	CO	+131 PTS

CITY LOUNGE

City lounge chair, high back with integral headrest, wooden legs
 Chauffeuse City Lounge avec appui-tête, 4 pieds bois
 City-Lounge mit Kopfstütze, 4 Holzbeine

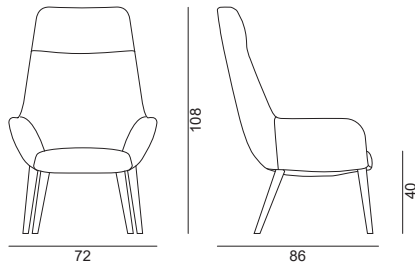

Cod. OCITYLP3

Steel inner frame; injection moulded polyurethane foam; seat pad made from cut-to-size polyurethane foam sheet. Chromed steel plate. Natural varnished solid ash wood legs; polypropylene glides.

Coque en polyuréthane expansée à mousse avec structure en acier; assise en polyuréthane expansée sélectionnée d'un bloc. Platine en acier chromé. Pieds en frêne massif verni; patins en polypropylène.

Sesselkörper aus kaltgeschäumtem Polyurethanschaum in Stahlrahmen; Sitz aus Polyurethanschaum. Verchromte Halterungsplatte (unter dem Sitz). Lackierte Beine aus Esche; Füße aus Polypropylen.



Upholstery in fire retardant foam



1 box
1 u. x box
0,530 M³



19,00
22,00

UPHOLSTERY / REVETEMENT / BEZUG

B01/B03	C01/C05	D02/D03	E01	P01
1217 PTS	1302 PTS	1340 PTS	1390 PTS	1608 PTS

UPHOLSTERY ON REQUEST / REVETEMENT SUR REQUETE / ÜBERZUG AUF ANFRAGE

D04/D06	E02/E03/E04	I01/I02	M01/M02/M03
1340 PTS	1390 PTS	1615 PTS	1733 PTS

BASE / BASE / GESTELL

	Oak varnished solid ash wood Frêne massif verni chêne Esche massiv Eiche hell lackiert	FSFK4	=
	Walnut varnished solid ash wood Frêne massif verni noyer canaletto Esche massiv Nussbaum Kanaletto lackiert	FSFN4	=
	Anthracite varnished solid ash wood Frêne massif verni gris ombre Esche massiv Dunkelgrau lackiert	FSFG4	=

City lounge chair, high back, wooden legs
 Chauffeuse City Lounge haute, 4 pieds bois
 City-Lounge hoch, 4 Holzbeine

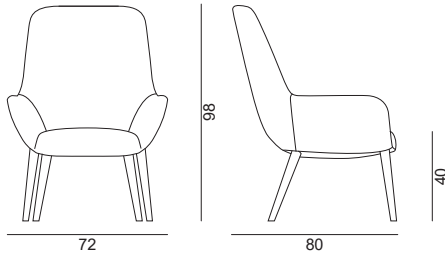

Cod. OCITYLA3

Steel inner frame; injection moulded polyurethane foam; seat pad made from cut-to-size polyurethane foam sheet. Chromed steel plate. Natural varnished solid ash wood legs; polypropylene glides.

Coque en polyuréthane expansée à mousse avec structure en acier; assise en polyuréthane expansée sélectionnée d'un bloc. Platine en acier chromé. Pieds en frêne massif verni; patins en polypropylène.

Sesselkörper aus kaltgeschäumtem Polyurethanschaum in Stahlrahmen; Sitz aus Polyurethanschaum. Verchromte Halterungsplatte (unter dem Sitz). Lackierte Beine aus Esche; Füße aus Polypropylen.



Upholstery in fire retardant foam



1 box
 1 u. x box
 0,530 M³



17,50
 20,50

UPHOLSTERY / REVETEMENT / BEZUG

B01/B03	C01/C05	D02/D03	E01	P01
1127 PTS	1196 PTS	1239 PTS	1279 PTS	1484 PTS

UPHOLSTERY ON REQUEST / REVETEMENT SUR REQUETE / ÜBERZUG AUF ANFRAGE

D04/D06	E02/E03/E04	I01/I02	M01/M02/M03
1239 PTS	1279 PTS	1479 PTS	1582 PTS

BASE / BASE / GESTELL

	Oak varnished solid ash wood Frêne massif verni chêne Esche massiv Eiche hell lackiert	FSFK4	=
	Walnut varnished solid ash wood Frêne massif verni noyer canaletto Esche massiv Nussbaum Kanaletto lackiert	FSFN4	=
	Anthracite varnished solid ash wood Frêne massif verni gris ombre Esche massiv Dunkelgrau lackiert	FSFG4	=

CITY LOUNGE

City lounge chair, mid back, wooden legs
 Chauffeuse City Lounge basse, 4 pieds bois
 City-Lounge niedrig, 4 Holzbeine

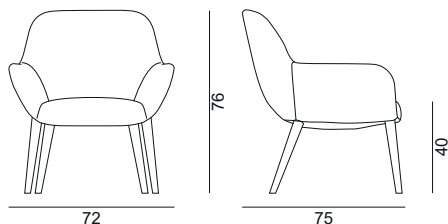

Cod. OCITYLB3

Steel inner frame; injection moulded polyurethane foam; seat pad made from cut-to-size polyurethane foam sheet. Chromed steel plate. Natural varnished solid ash wood legs; polypropylene glides.

Coque en polyuréthane expansée à mousse avec structure en acier; assise en polyuréthane expansée sélectionnée d'un bloc. Platine en acier chromé. Pieds en frêne massif verni; patins en polypropylène.

Sesselkörper aus kaltgeschäumtem Polyurethanschaum in Stahlrahmen; Sitz aus Polyurethanschaum. Verchromte Halterungsplatte (unter dem Sitz). Lackierte Beine aus Esche; Füße aus Polypropylen.

 Upholstery in fire retardant foam

 1 box
1 u. x box
0,530 M³

 16,00
19,00

UPHOLSTERY / REVETEMENT / BEZUG

B01/B03	C01/C05	D02/D03	E01	P01
1034 PTS	1095 PTS	1133 PTS	1177 PTS	1355 PTS

UPHOLSTERY ON REQUEST / REVETEMENT SUR REQUETE / ÜBERZUG AUF ANFRAGE

D04/D06	E02/E03/E04	I01/I02	M01/M02/M03
1133 PTS	1177 PTS	1365 PTS	1462 PTS

BASE / BASE / GESTELL

	Oak varnished solid ash wood Frêne massif verni chêne Esche massiv Eiche hell lackiert	FSFK4	=
	Walnut varnished solid ash wood Frêne massif verni noyer canaletto Esche massiv Nussbaum Kanaletto lackiert	FSFN4	=
	Anthracite varnished solid ash wood Frêne massif verni gris ombre Esche massiv Dunkelgrau lackiert	FSFG4	=

City lounge pouff, wooden legs

Pouf City Lounge, 4 pieds bois

City Lounge Barhocker, 4 Holzbeine

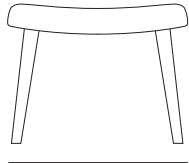

48

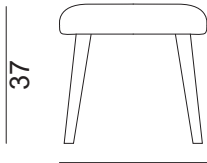

48

37

Cod. OCITYL03

Beech plywood inner frame, cut-to-size polyurethane foam sheet. Chromed steel plate. Natural varnished solid ash wood legs; polypropylene glides.

Assise interne en multi-plis de hêtre; rembourrage en polyuréthane expansée sélectionné par un bloc. Platine en acier chromé. Pieds en frêne massif; pieds en polypropylène.

Innensitz aus Buchensperrholz; Polsterung aus Polyurethanschaum. Verchromte Stahlplatte. Lackierte Füße aus massiver Esche; Füße aus Polypropylen.



Upholstery in fire retardant foam



1 box
1 u. x box
0,170 M³



6,00
7,50



UPHOLSTERY / REVETEMENT / BEZUG

B01/B03	C01/C05	D02/D03	E01	P01
478 PTS	490 PTS	497 PTS	512 PTS	542 PTS

UPHOLSTERY ON REQUEST / REVETEMENT SUR REQUETE / ÜBERZUG AUF ANFRAGE

D04/D06	E02/E03/E04	I01/I02	M01/M02/M03
497 PTS	512 PTS	555 PTS	579 PTS

BASE / BASE / GESTELL

	Oak varnished solid ash wood Frêne massif verni chêne Esche massiv Eiche hell lackiert	FSFK4	=
	Walnut varnished solid ash wood Frêne massif verni noyer canaletto Esche massiv Nussbaum Kanaletto lackiert	FSFN4	=
	Anthracite varnished solid ash wood Frêne massif verni gris ombre Esche massiv Dunkelgrau lackiert	FSFG4	=

CITY DÉCO LOUNGE

Low City Déco Lounge armchair, 4 wooden legs
 Chauffeuse City Déco Lounge basse, 4 pieds bois
 Armsessel City Déco Lounge niedrig, 4 FüÙe aus Holz

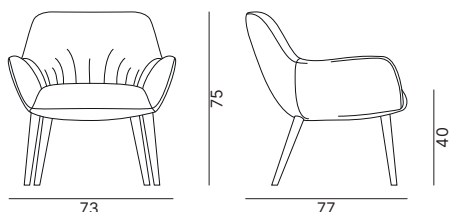

Cod. OCIDELB3

Shell in injection moulded polyurethane foam with steel frame; slab polyurethane foam seat; chromed steel plate; legs in varnished solid ash wood; soft pleated upholstery.

Coque en mousse de polyuréthane expansé avec structure en acier; assise en mousse de polyuréthane expansée sectionnée à partir du bloc; plaque en acier chromé; piètement en frêne massif verni; patins en polyéthylène; revêtement avec plis souples.

Sitzschale aus geschäumtem Polyurethanschaum mit Gestell aus Stahl; Sitz aus Polyurethanschaum, in Block geschnitten; Platte aus verchromtem Stahl; Beine aus massiver Esche lackiert; Überzug mit weichen Falten.

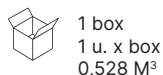

1 box
1 u. x box
0,528 M³



16,00
19,00

UPHOLSTERY / REVETEMENT / BEZUG

D02/D03	E01
1186 PTS	1265 PTS

UPHOLSTERY ON REQUEST / REVETEMENT SUR REQUETE / ÜBERZUG AUF ANFRAGE

D04	E02/E03/E04	I01
1186 PTS	1265 PTS	1346 PTS

BASE / BASE / GESTELL

	Oak varnished solid ash wood Frêne massif verni chêne Esche massiv Eiche hell lackiert	FSFK4	=
	Walnut varnished solid ash wood Frêne massif verni noyer canaletto Esche massiv Nussbaum Kanaletto lackiert	FSFN4	=
	Anthracite varnished solid ash wood Frêne massif verni gris ombre Esche massiv Dunkelgrau lackiert	FSFG4	=

ON REQUEST ONLY / SUR REQUETE / AUF ANFRAGE



Powder coated legs in a special finish, 2-unit minimum order

Piètement en coloris spéciaux, à partir de 2 pièces
Gestell nach Kundenwunsch, ab 2 Stück

Price on request for special varnish finishes / Pour vernis spécifiques, devis sur requête / Sonderlackfarben auf Anfrage

VERN

+42 PTS

Low City Déco Lounge armchair, 4 déco legs
 Chauffeuse City Déco Lounge basse, 4 pieds déco
 Armsessel City Déco Lounge niedrig, 4 Füße déco

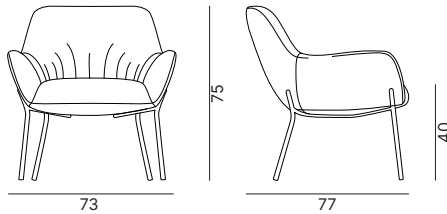

Cod. OCIDELB2

Shell in injection moulded polyurethane foam with steel frame; slab polyurethane foam seat; frame in powder coated steel tube; adjustable polyethylene glides with felt pad or base for hard floors; soft pleated upholstery.

Coque en mousse de polyuréthane expansé avec structure en acier; assise en mousse de polyuréthane expansée sectionnée à partir du bloc; cadre en tube d'acier verni; patins réglables en polyéthylène avec feutre ou avec base pour sols durs; revêtement avec plis souples.

Sitzschale aus geschäumtem Polyurethanschaum mit Gestell aus Stahl; Sitz aus Polyurethanschaum, in Block geschnitten; Gestell aus Stahlrohr lackiert; schwenkbare Füße aus Polyethylen mit Filz oder Sockel für harte Fußböden; Überzug mit weichen Falten.

 1 box
 1 u. x box
 0,528 M³

 16,00
 19,00

UPHOLSTERY / REVETEMENT / BEZUG

D02/D03	E01
1293 PTS	1372 PTS





UPHOLSTERY ON REQUEST / REVETEMENT SUR REQUETE / ÜBERZUG AUF ANFRAGE

D04	E02/E03/E04	I01
1293 PTS	1372 PTS	1453 PTS

FRAME / CADRE / GESTELL

	Powder coated frame in anthracite Cadre verni gris ombre Gestell Dunkelgrau lackiert	FST32	=
--	---	--------------	---

ON REQUEST ONLY / SUR REQUETE / AUF ANFRAGE

	Gold powder coated frame Structure vernie or Gestell Gold lackiert	OR	+95 PTS
	Bronze powder coated frame Structure vernie bronze Gestell Bronze lackiert	BR	+127 PTS
	Corten powder coated frame Structure vernie corten Gestell Corten lackiert	CO	+127 PTS
	Powder coated frame in a special finish, 2-unit minimum order Cadre en coloris spéciaux, à partir de 2 pièces Gestell: Sonderlackierung nach Kundenwunsch, ab 2 Stück <small>Price on request for special varnish finishes / Pour vernis spécifiques, devis sur requête / Sonderlackfarben auf Anfrage</small>	VERN	+85 PTS

ACCESSORIES / ACCESSOIRES / ZUBEHÖR

	Protective pads for hardwood Feutre pour sols en bois Filzgleiter für Holzböden	ACC21	+4 PTS
--	--	--------------	--------

SMALL

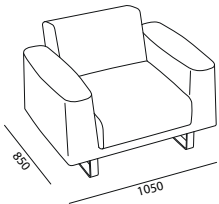

OAVAN101

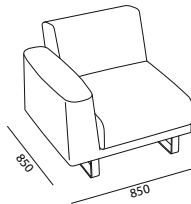

OAVAN102

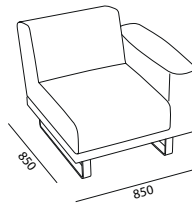

OAVAN103

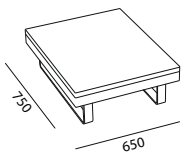

OAVAN105

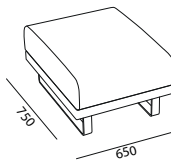

OAVAN106

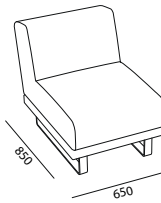

OAVAN107

LARGE

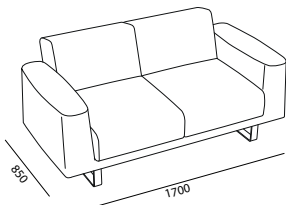

OAVAN201

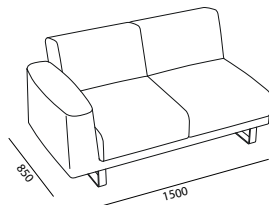

OAVAN202

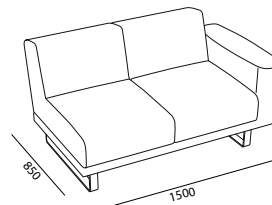

OAVAN203

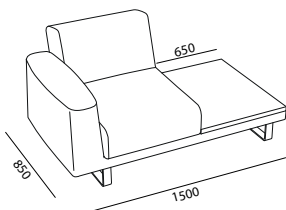

OAVAN212

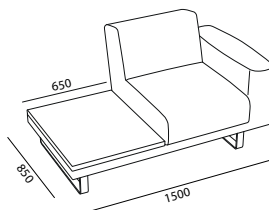

OAVAN213

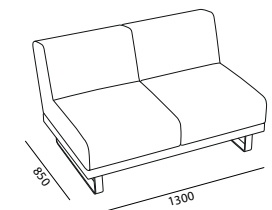

OAVAN214

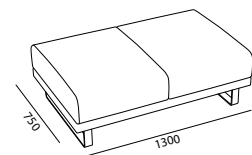

OAVAN216

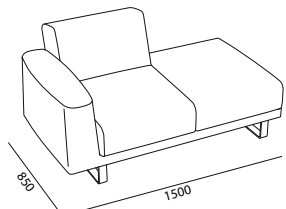

OAVAN220

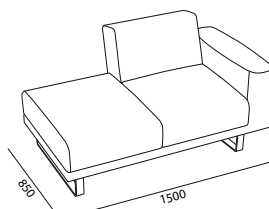

OAVAN221

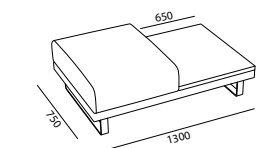

OAVAN217

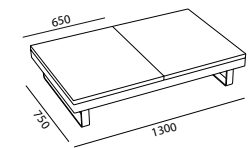

OAVAN218

Configurations and sizes

Modules composables

Modulare Elemente

EXTRA LARGE

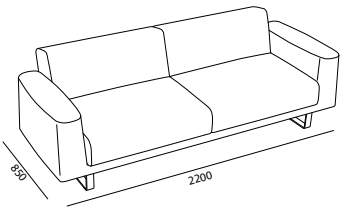

OAVAN301

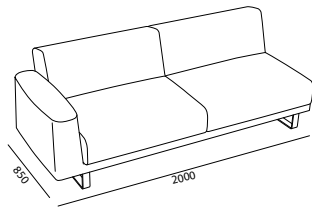

OAVAN302

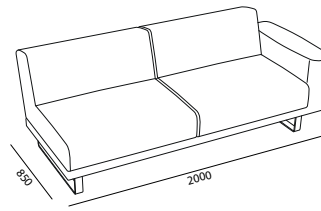

OAVAN303

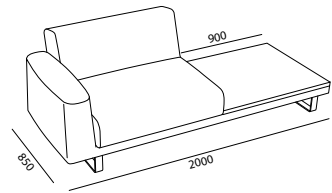

OAVAN312

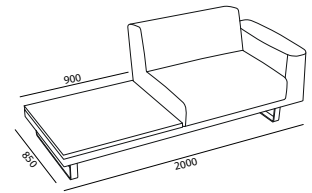

OAVAN313

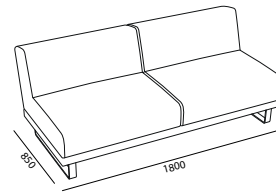

OAVAN314

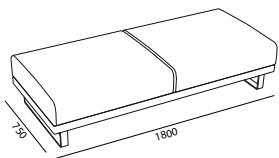

OAVAN316

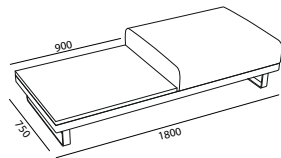

OAVAN317

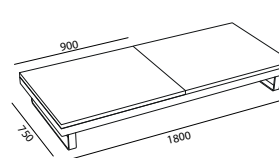

OAVAN318

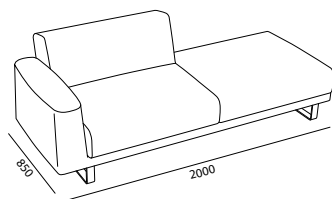

OAVAN320

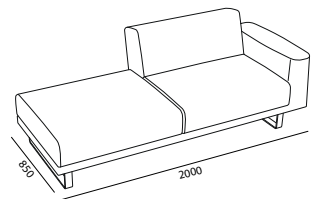

OAVAN321

CORNER TABLE / TABLE BASSE ANGULAIRE / BEISTELLTISCH

Modular corner table (A), can be used as a free standing unit too (B)

Table basse (A) à utiliser même singulièrement (B)

Beistelltisch (A), auch als Kaffeetisch verwendbar (B)

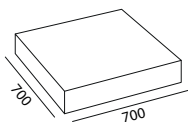

CT45207

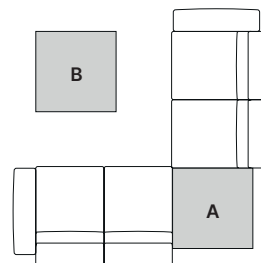

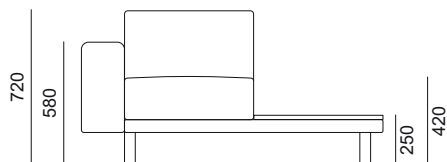

Structural inner frame made from painted steel tube; structural frame of armrests made from steel rod. Inner frame of seat and back made from birch plywood. Padding of armrests made from polyurethane foam and resinated wadding; padding of seat and backrest made of highly elastic polyurethane foam slabs with resinated wadding. 50x9mm steel legs with polypropylene glides; felt pads for wooden flooring included.

Cadre en tube d'acier verni; structure accoudoir en tube d'acier. Assise et dossier internes en contreplaqué de bouleau. Rembourrage accoudoir en polyuréthane expansée à mousse et résine d'ouate; rembourrage d'assise et de dossier en polyuréthane sectionné à mousse par un bloc hautement élastique et résine rembourrée. Pieds en acier larg. 50 mm ép. 9mm avec patins en polypropylène; patins de feutres pour sols délicats inclus.

Lackiertes Stahlrohrgestell; Armlehnenstruktur aus Stahlstäben. Interner Sitz und Rückenlehne aus Birkenperrholz. Armlehnenpolsterung aus kaltgeschäumtem Polyurethanschaum und Wattierung-Harz; Sitz- und Rückenlehnenpolsterung aus hochelastischem Polyurethan-Blockschaum und Wattierung-Harz. Stahlbeine 50 mm breit, 9 mm stark mit Polypropylen-Kufen; Filzpolster für weichen Böden inklusive.

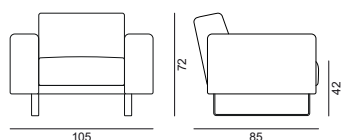

Cod. OAVAN101

UPHOLSTERY / REVETEMENT / BEZUG

B01/B03	C01/C05	D02/D03	E01	P01
2.098 PTS	2.228 PTS	2.313 PTS	2.426 PTS	2.893 PTS

D04/D06	E02/E03/E04	I01/I02	M01/M02/M03
2.313 PTS	2.426 PTS	2.854 PTS	3.077 PTS

Upholstery in fire retardant foam / Rembourrage avec mousse non-feu / Feuerfeste Gummipolsterung +113 PTS

KG 37,9
44,4

2 box
0,630 M³

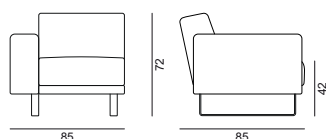

Cod. OAVAN102

UPHOLSTERY / REVETEMENT / BEZUG

B01/B03	C01/C05	D02/D03	E01	P01
1.838 PTS	1.944 PTS	2.010 PTS	2.100 PTS	2.502 PTS

UPHOLSTERY ON REQUEST / REVETEMENT SUR REQUETE / BEZUG AUF ANFRAGE

D04/D06	E02/E03/E04	I01/I02	M01/M02/M03
2.010 PTS	2.100 PTS	2.439 PTS	2.617 PTS

Upholstery in fire retardant foam / Rembourrage avec mousse non-feu / Feuerfeste Gummipolsterung +113 PTS

KG 31,6
38,1

2 box
0,630 M³

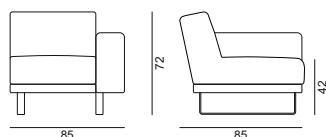

Cod. OAVAN103

UPHOLSTERY / REVETEMENT / BEZUG

B01/B03	C01/C05	D02/D03	E01	P01
1.838 PTS	1.944 PTS	1.962 PTS	2.100 PTS	2.502 PTS

UPHOLSTERY ON REQUEST / REVETEMENT SUR REQUETE / BEZUG AUF ANFRAGE

D04/D06	E02/E03/E04	I01/I02	M01/M02/M03
1.962 PTS	2.100 PTS	2.439 PTS	2.617 PTS

Upholstery in fire retardant foam / Rembourrage avec mousse non-feu / Feuerfeste Gummipolsterung +113 PTS

KG 31,6
38,1

2 box
0,630 M³

Avana SMALL



Cod. OAVAN105

UPHOLSTERY / REVETEMENT / BEZUG

B01/B03	C01/C05	D02/D03	E01	P01
941 PTS	975 PTS	996 PTS	1.025 PTS	1.134 PTS

UPHOLSTERY ON REQUEST / REVETEMENT SUR REQUETE / BEZUG AUF ANFRAGE

D04/D06	E02/E03/E04	I01/I02	M01/M02/M03
996 PTS	1.025 PTS	1.134 PTS	1.191 PTS

Upholstery in fire retardant foam / Rembourrage avec mousse non-feu / Feuerfeste Gummipolsterung **+18 PTS**

23,5
30,0

2 box
0,346 M³

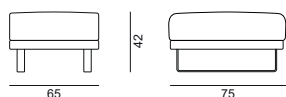

Cod. OAVAN106

UPHOLSTERY / REVETEMENT / BEZUG

B01/B03	C01/C05	D02/D03	E01	P01
1.193 PTS	1.271 PTS	1.319 PTS	1.386 PTS	1.484 PTS

UPHOLSTERY ON REQUEST / REVETEMENT SUR REQUETE / BEZUG AUF ANFRAGE

D04/D06	E02/E03/E04	I01/I02	M01/M02/M03
1.319 PTS	1.386 PTS	1.640 PTS	1.771 PTS

Upholstery in fire retardant foam / Rembourrage avec mousse non-feu / Feuerfeste Gummipolsterung **+34 PTS**

19,0
25,5

2 box
0,346 M³

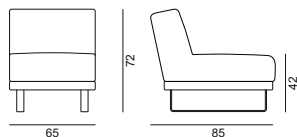

Cod. OAVAN107

UPHOLSTERY / REVETEMENT / BEZUG

B01/B03	C01/C05	D02/D03	E01	P01
1.439 PTS	1.523 PTS	1.575 PTS	1.645 PTS	1.887 PTS

UPHOLSTERY ON REQUEST / REVETEMENT SUR REQUETE / BEZUG AUF ANFRAGE

D04/D06	E02/E03/E04	I01/I02	M01/M02/M03
1.575 PTS	1.645 PTS	1.914 PTS	2.054 PTS

Upholstery in fire retardant foam / Rembourrage avec mousse non-feu / Feuerfeste Gummipolsterung **+113 PTS**

25,3
31,8

2 box
0,630 M³

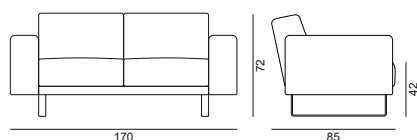

Cod. OAVAN201

UPHOLSTERY / REVETEMENT / BEZUG

B01/B03	C01/C05	D02/D03	E01	P01
2.892 PTS	3.075 PTS	3.191 PTS	3.346 PTS	4.007 PTS

UPHOLSTERY ON REQUEST / REVETEMENT SUR REQUETE / BEZUG AUF ANFRAGE

D04/D06	E02/E03/E04	I01/I02	M01/M02/M03
3.191 PTS	3.346 PTS	3.939 PTS	4.248 PTS

Upholstery in fire retardant foam / Rembourrage avec mousse non-feu / Feuerfeste Gummipolsterung +229 PTS

KG 54,3
62,8

2 box
0,975 M³

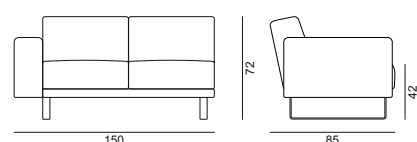

Cod. OAVAN202

UPHOLSTERY / REVETEMENT / BEZUG

B01/B03	C01/C05	D02/D03	E01	P01
2.584 PTS	2.752 PTS	2.859 PTS	3.004 PTS	3.675 PTS

UPHOLSTERY ON REQUEST / REVETEMENT SUR REQUETE / BEZUG AUF ANFRAGE

D04/D06	E02/E03/E04	I01/I02	M01/M02/M03
2.859 PTS	3.004 PTS	3.553 PTS	3.839 PTS

Upholstery in fire retardant foam / Rembourrage avec mousse non-feu / Feuerfeste Gummipolsterung +229 PTS

KG 48,2
56,7

2 box
0,975 M³

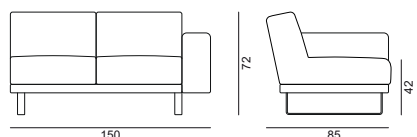

Cod. OAVAN203

UPHOLSTERY / REVETEMENT / BEZUG

B01/B03	C01/C05	D02/D03	E01	P01
2.584 PTS	2.752 PTS	2.859 PTS	3.004 PTS	3.675 PTS

UPHOLSTERY ON REQUEST / REVETEMENT SUR REQUETE / BEZUG AUF ANFRAGE

D04/D06	E02/E03/E04	I01/I02	M01/M02/M03
2.859 PTS	3.004 PTS	3.553 PTS	3.839 PTS

Upholstery in fire retardant foam / Rembourrage avec mousse non-feu / Feuerfeste Gummipolsterung +229 PTS

KG 48,2
56,7

2 box
0,975 M³

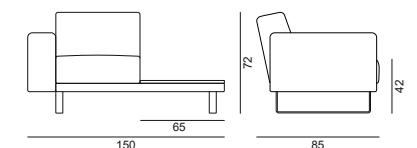

Cod. OAVAN212

UPHOLSTERY / REVETEMENT / BEZUG

B01/B03	C01/C05	D02/D03	E01	P01
2.177 PTS	2.289 PTS	2.361 PTS	2.456 PTS	2.862 PTS

UPHOLSTERY ON REQUEST / REVETEMENT SUR REQUETE / BEZUG AUF ANFRAGE

D04/D06	E02/E03/E04	I01/I02	M01/M02/M03
2.361 PTS	2.456 PTS	2.817 PTS	3.006 PTS

Upholstery in fire retardant foam / Rembourrage avec mousse non-feu / Feuerfeste Gummipolsterung +113 PTS

KG 46,2
54,7

2 box
0,975 M³

Avana LARGE

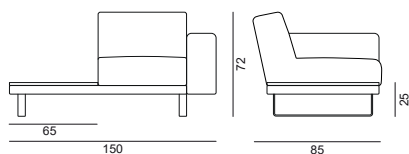

Cod. OAVAN213

UPHOLSTERY / REVETEMENT / BEZUG

B01/B03	C01/C05	D02/D03	E01	P01
2.177 PTS	2.289 PTS	2.361 PTS	2.456 PTS	2.862 PTS

UPHOLSTERY ON REQUEST / REVETEMENT SUR REQUETE / BEZUG AUF ANFRAGE

D04/D06	E02/E03/E04	I01/I02	M01/M02/M03
2.361 PTS	2.456 PTS	2.817 PTS	3.006 PTS

Upholstery in fire retardant foam / Rembourrage avec mousse non-feu / Feuerfeste Gummipolsterung +113 PTS

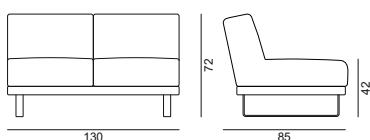
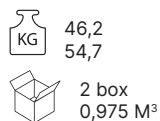

Cod. OAVAN214

UPHOLSTERY / REVETEMENT / BEZUG

B01/B03	C01/C05	D02/D03	E01	P01
2.370 PTS	2.524 PTS	2.621 PTS	2.752 PTS	3.323 PTS

UPHOLSTERY ON REQUEST / REVETEMENT SUR REQUETE / BEZUG AUF ANFRAGE

D04/D06	E02/E03/E04	I01/I02	M01/M02/M03
2.621 PTS	2.752 PTS	3.252 PTS	3.512 PTS

Upholstery in fire retardant foam / Rembourrage avec mousse non-feu / Feuerfeste Gummipolsterung +229 PTS

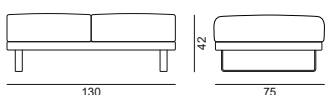
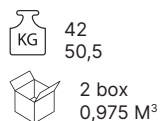

Cod. OAVAN216

UPHOLSTERY / REVETEMENT / BEZUG

B01/B03	C01/C05	D02/D03	E01	P01
1.655 PTS	1.757 PTS	1.822 PTS	1.911 PTS	2.347 PTS

UPHOLSTERY ON REQUEST / REVETEMENT SUR REQUETE / BEZUG AUF ANFRAGE

D04/D06	E02/E03/E04	I01/I02	M01/M02/M03
1.822 PTS	1.911 PTS	2.246 PTS	2.420 PTS

Upholstery in fire retardant foam / Rembourrage avec mousse non-feu / Feuerfeste Gummipolsterung +92 PTS

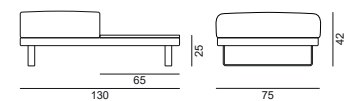
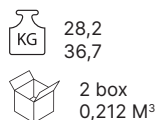

Cod. OAVAN217

UPHOLSTERY / REVETEMENT / BEZUG

B01/B03	C01/C05	D02/D03	E01	P01
1.497 PTS	1.573 PTS	1.619 PTS	1.685 PTS	2.016 PTS

UPHOLSTERY ON REQUEST / REVETEMENT SUR REQUETE / BEZUG AUF ANFRAGE

D04/D06	E02/E03/E04	I01/I02	M01/M02/M03
1.619 PTS	1.685 PTS	1.932 PTS	2.062 PTS

Upholstery in fire retardant foam / Rembourrage avec mousse non-feu / Feuerfeste Gummipolsterung +59 PTS

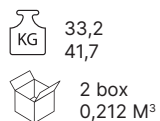

Cod. OAVAN218

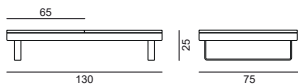

KG 45,3
53,8

2 box
0,212 M³

UPHOLSTERY / REVETEMENT / BEZUG

B01/B03	C01/C05	D02/D03	E01	P01
1.326 PTS	1.377 PTS	1.411 PTS	1.456 PTS	1.549 PTS

UPHOLSTERY ON REQUEST / REVETEMENT SUR REQUETE / BEZUG AUF ANFRAGE

D04/D06	E02/E03/E04	I01/I02	M01/M02/M03
1.411 PTS	1.456 PTS	1.627 PTS	1.715 PTS

Upholstery in fire retardant foam / Rembourrage avec mousse non-feu / Feuerfeste Gummipolsterung **+37 PTS**

Cod. OAVAN220

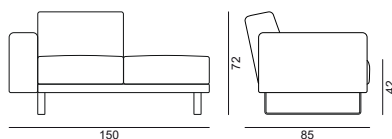

KG 41,3
49,8

2 box
0,975 M³

UPHOLSTERY / REVETEMENT / BEZUG

B01/B03	C01/C05	D02/D03	E01	P01
2.346 PTS	2.489 PTS	2.580 PTS	2.703 PTS	3.208 PTS

UPHOLSTERY ON REQUEST / REVETEMENT SUR REQUETE / BEZUG AUF ANFRAGE

D04/D06	E02/E03/E04	I01/I02	M01/M02/M03
2.580 PTS	2.703 PTS	3.170 PTS	3.412 PTS

Upholstery in fire retardant foam / Rembourrage avec mousse non-feu / Feuerfeste Gummipolsterung **+148 PTS**

Cod. OAVAN221

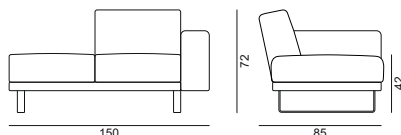

KG 41,3
49,8

2 box
0,975 M³

UPHOLSTERY / REVETEMENT / BEZUG

B01/B03	C01/C05	D02/D03	E01	P01
2.346 PTS	2.489 PTS	2.580 PTS	2.703 PTS	3.208 PTS

UPHOLSTERY ON REQUEST / REVETEMENT SUR REQUETE / BEZUG AUF ANFRAGE

D04/D06	E02/E03/E04	I01/I02	M01/M02/M03
2.580 PTS	2.703 PTS	3.170 PTS	3.412 PTS

Upholstery in fire retardant foam / Rembourrage avec mousse non-feu / Feuerfeste Gummipolsterung **+148 PTS**

Avana EXTRA LARGE

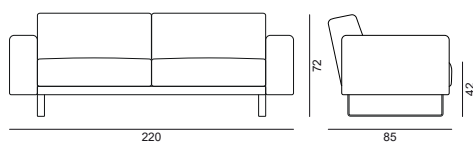

Cod. OAVAN301

UPHOLSTERY / REVETEMENT / BEZUG

B01/B03	C01/C05	D02/D03	E01	P01
3.246 PTS	3.477 PTS	3.622 PTS	3.818 PTS	4.639 PTS

UPHOLSTERY ON REQUEST / REVETEMENT SUR REQUETE / BEZUG AUF ANFRAGE

D04/D06	E02/E03/E04	I01/I02	M01/M02/M03
3.622 PTS	3.818 PTS	4.564 PTS	4.953 PTS

Upholstery in fire retardant foam / Rembourrage avec mousse non-feu / Feuerfeste Gummipolsterung +262 PTS

KG 58,4
68,9

2 box
1,230 M³

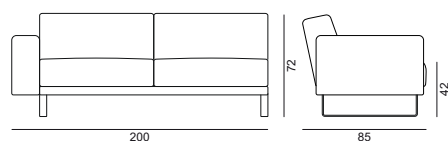

Cod. OAVAN302

UPHOLSTERY / REVETEMENT / BEZUG

B01/B03	C01/C05	D02/D03	E01	P01
2.971 PTS	3.178 PTS	3.307 PTS	3.483 PTS	4.158 PTS

UPHOLSTERY ON REQUEST / REVETEMENT SUR REQUETE / BEZUG AUF ANFRAGE

D04/D06	E02/E03/E04	I01/I02	M01/M02/M03
3.307 PTS	3.483 PTS	4.153 PTS	4.503 PTS

Upholstery in fire retardant foam / Rembourrage avec mousse non-feu / Feuerfeste Gummipolsterung +262 PTS

KG 52,1
62,6

2 box
1,230 M³

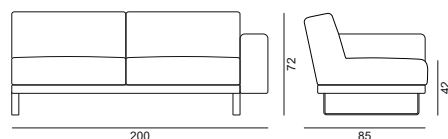

Cod. OAVAN303

UPHOLSTERY / REVETEMENT / BEZUG

B01/B03	C01/C05	D02/D03	E01	P01
2.971 PTS	3.178 PTS	3.307 PTS	3.483 PTS	4.158 PTS

UPHOLSTERY ON REQUEST / REVETEMENT SUR REQUETE / BEZUG AUF ANFRAGE

D04/D06	E02/E03/E04	I01/I02	M01/M02/M03
3.307 PTS	3.483 PTS	4.153 PTS	4.503 PTS

Upholstery in fire retardant foam / Rembourrage avec mousse non-feu / Feuerfeste Gummipolsterung +262 PTS

KG 52,1
62,6

2 box
1,230 M³

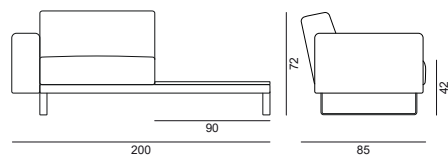

Cod. OAVAN312

UPHOLSTERY / REVETEMENT / BEZUG

B01/B03	C01/C05	D02/D03	E01	P01
2.369 PTS	2.503 PTS	2.587 PTS	2.701 PTS	3.181 PTS

UPHOLSTERY ON REQUEST / REVETEMENT SUR REQUETE / BEZUG AUF ANFRAGE

D04/D06	E02/E03/E04	I01/I02	M01/M02/M03
2.587 PTS	2.701 PTS	3.134 PTS	3.361 PTS

Upholstery in fire retardant foam / Rembourrage avec mousse non-feu / Feuerfeste Gummipolsterung +130 PTS

KG 49,9
60,4

2 box
1,230 M³

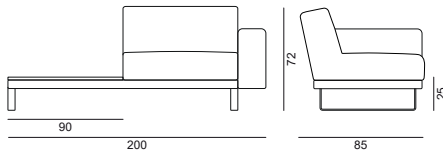

Cod. OAVAN313

UPHOLSTERY / REVETEMENT / BEZUG

B01/B03	C01/C05	D02/D03	E01	P01
2.369 PTS	2.503 PTS	2.587 PTS	2.701 PTS	3.181 PTS

UPHOLSTERY ON REQUEST / REVETEMENT SUR REQUETE / BEZUG AUF ANFRAGE

D04/D06	E02/E03/E04	I01/I02	M01/M02/M03
2.587 PTS	2.701 PTS	3.134 PTS	3.361 PTS

Upholstery in fire retardant foam / Rembourrage avec mousse non-feu / Feuerfeste Gummipolsterung **+130 PTS**

49,9
60,4

2 box
1,230 M³

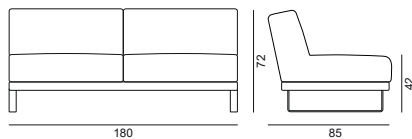

Cod. OAVAN314

UPHOLSTERY / REVETEMENT / BEZUG

B01/B03	C01/C05	D02/D03	E01	P01
2.703 PTS	2.877 PTS	2.986 PTS	3.132 PTS	3.727 PTS

UPHOLSTERY ON REQUEST / REVETEMENT SUR REQUETE / BEZUG AUF ANFRAGE

D04/D06	E02/E03/E04	I01/I02	M01/M02/M03
2.986 PTS	3.132 PTS	3.692 PTS	3.983 PTS

Upholstery in fire retardant foam / Rembourrage avec mousse non-feu / Feuerfeste Gummipolsterung **+262 PTS**

45,6
56,1

2 box
1,230 M³

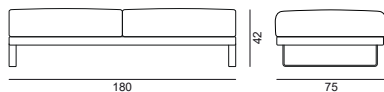

Cod. OAVAN316

UPHOLSTERY / REVETEMENT / BEZUG

B01/B03	C01/C05	D02/D03	E01	P01
2.015 PTS	2.147 PTS	2.230 PTS	2.344 PTS	2.806 PTS

UPHOLSTERY ON REQUEST / REVETEMENT SUR REQUETE / BEZUG AUF ANFRAGE

D04/D06	E02/E03/E04	I01/I02	M01/M02/M03
2.230 PTS	2.344 PTS	2.772 PTS	2.995 PTS

Upholstery in fire retardant foam / Rembourrage avec mousse non-feu / Feuerfeste Gummipolsterung **+80 PTS**

30,7
41,2

2 box
0,271 M³

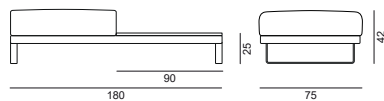

Cod. OAVAN317

UPHOLSTERY / REVETEMENT / BEZUG

B01/B03	C01/C05	D02/D03	E01	P01
1.698 PTS	1.795 PTS	1.858 PTS	1.942 PTS	2.325 PTS

UPHOLSTERY ON REQUEST / REVETEMENT SUR REQUETE / BEZUG AUF ANFRAGE

D04/D06	E02/E03/E04	I01/I02	M01/M02/M03
1.858 PTS	1.942 PTS	2.260 PTS	2.426 PTS

Upholstery in fire retardant foam / Rembourrage avec mousse non-feu / Feuerfeste Gummipolsterung **+76 PTS**

36,2
46,7

2 box
0,271 M³

Avana EXTRA LARGE

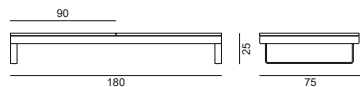

Cod. OAVAN318

UPHOLSTERY / REVETEMENT / BEZUG

B01/B03	C01/C05	D02/D03	E01	P01
1.442 PTS	1.507 PTS	1.549 PTS	1.605 PTS	1.633 PTS

UPHOLSTERY ON REQUEST / REVETEMENT SUR REQUETE / BEZUG AUF ANFRAGE

D04/D06	E02/E03/E04	I01/I02	M01/M02/M03
1.549 PTS	1.605 PTS	1.819 PTS	1.931 PTS

Upholstery in fire retardant foam / Rembourrage avec mousse non-feu / Feuerfeste Gummipolsterung +56 PTS

KG 41,7
52,2

2 box
0,271 M³

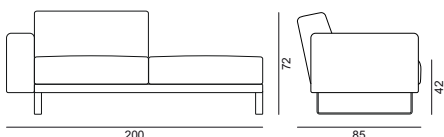

Cod. OAVAN320

UPHOLSTERY / REVETEMENT / BEZUG

B01/B03	C01/C05	D02/D03	E01	P01
2.601 PTS	2.788 PTS	2.908 PTS	3.068 PTS	3.727 PTS

UPHOLSTERY ON REQUEST / REVETEMENT SUR REQUETE / BEZUG AUF ANFRAGE

D04/D06	E02/E03/E04	I01/I02	M01/M02/M03
2.908 PTS	3.068 PTS	3.677 PTS	3.995 PTS

Upholstery in fire retardant foam / Rembourrage avec mousse non-feu / Feuerfeste Gummipolsterung +171 PTS

KG 44,6
55,1

2 box
1,230 M³

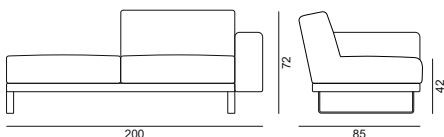

Cod. OAVAN321

UPHOLSTERY / REVETEMENT / BEZUG

B01/B03	C01/C05	D02/D03	E01	P01
2.601 PTS	2.788 PTS	2.908 PTS	3.068 PTS	3.727 PTS

UPHOLSTERY ON REQUEST / REVETEMENT SUR REQUETE / BEZUG AUF ANFRAGE

D04/D06	E02/E03/E04	I01/I02	M01/M02/M03
2.908 PTS	3.068 PTS	3.677 PTS	3.995 PTS

Upholstery in fire retardant foam / Rembourrage avec mousse non-feu / Feuerfeste Gummipolsterung +171 PTS

KG 44,6
55,1

2 box
1,230 M³

CORNER TABLE / TABLE BASSE ANGULAIRE / BEISTELLTISCH

Cod. CT45207





FINISHES / FINITIONS / AUSFÜHRUNGEN

BA / CL / OL / RK / NO / EC	LA
567 PTS	+ 214 PTS



KG 27,0
28,0

2 box
0,074 M³

FRAME / CADRE / GESTELL





	Powder coated metal legs, anthracite finish Piètement métal verni gris ombre <i>Gestell Metall Dunkelgrau lackiert</i>	GAM11VO	=
	Chrome metal legs Piètement métal chromé <i>Gestell Metall verchromt</i>	GAM11CR	+42 PTS

OPTIONS/ OPTIONS / OPTIONEN



	Upholstery of armrest top in faux leather B03 or leather P01 (upcharge per single armrest) Revêtement accoudoir spécial en simili cuir B03 / cuir P01 (prix par accoudoir) <i>Sonder-Armlehnenbezug aus Kunstleder B03 / Leder P01 (Preis pro Armlehne)</i>	B03 RIVB03	P01 RIVP01
		+5 PTS	+46 PTS
	Matt lacquered table top Module table laqué mat <i>Matt lackierte Tischmodule</i>	650×750 LA	900×750 LA
		+63 PTS	+86 PTS

ACCESSORIES FOR TABLES / ACCESSOIRES MODULE TABLE / ZUBEHÖR FÜR TISCHMODULE

Not available with corner table CT4520 / Pas disponibles pour table basse angulaire CT45207 / Nicht auf Beistelltisch CT45207

	Swivel table in shadow grey lacquered MDF Table orbitale en MDF laqué gris ombre <i>MDF-Drehtischablage Dunkelgrau lackiert</i>	TAV15	+283 PTS
<small>Please note: one swivel table only can be fitted on 650mm long tables; one or two swivel tables can be fitted on 900mm long tables N.B. max 1 table orbitale par module L.65 cm; max 2 tables orbitales par module L.90 cm N.B.: max. 1 Drehtisch pro Holzmodul B. 65cm; max. 2 Drehtische pro Holzmodul B 90cm</small>			
	Kit of two USB chargers + one power socket for type-F plugs Kit 2 USB, 1 prise UE (type F) <i>Kit 2 USB-Dosen, 1 EU-Dose (Typ F)</i>	USB02EU	+251 PTS
	Kit of two USB chargers + one power socket for type-G UK plugs Kit 2 USB, 1 prise UK (type G) <i>Kit 2 USB-Dosen, 1 UK-Dose (Typ G)</i>	USB02UK	+251 PTS
	Kit of two USB chargers + one power socket for type-A US plugs Kit 2 USB, 1 prise USA (type A) <i>Kit 2 USB-Dosen, 1 US-Dose (Typ A)</i>	USB02USA	+306 PTS

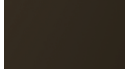
ON REQUEST ONLY / SUR REQUETE / AUF ANFRAGE

	Gold powder coated frame (upcharge per single module) Structure vernie or (prix unitaire pour chaque module) <i>Gestell Gold lackiert (Preis pro Einzelmodul)</i>	OR	+138 PTS
	Bronze powder coated frame (upcharge per single module) Structure vernie bronze (prix unitaire pour chaque module) <i>Gestell Gold lackiert (Preis pro Einzelmodul)</i>	BR	+138 PTS
	Corten powder coated frame (upcharge per single module) Structure vernie corten (prix unitaire pour chaque module) <i>Gestell Gold lackiert (Preis pro Einzelmodul)</i>	CO	+138 PTS

Decorative cushions

Coussin décoratif

Dekokissen



Rectangular or square decorative cushion; polyester fibre padding wrapped in nonwoven fabric.
 Coussin décoratif carré ou rectangulaire; rembourrage en fibre de polyester revêtu de TNT.
 Dekokissen quadratisch oder viereckig, Polsterung aus Polyesterfasern, die mit Vliesstoff umhüllt ist.

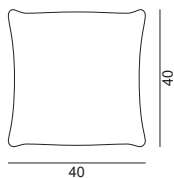

Cod. OPILL001

UPHOLSTERY / REVETEMENT / BEZUG

B01/B03	C01/C05	D02/D03	E01	P01
80 PTS	89 PTS	113 PTS	121 PTS	137 PTS

D04/D06	E02/E03/E04	I01/I02	M01/M02/M03
113 PTS	121 PTS	176 PTS	205 PTS

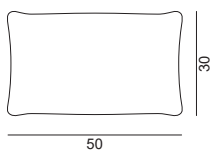

Cod. OPILL002

UPHOLSTERY / REVETEMENT / BEZUG

B01/B03	C01/C05	D02/D03	E01	P01
80 PTS	89 PTS	113 PTS	121 PTS	137 PTS

D04/D06	E02/E03/E04	I01/I02	M01/M02/M03
113 PTS	121 PTS	176 PTS	205 PTS

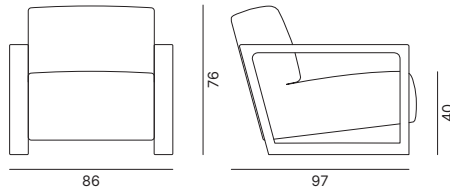

Cod. OARCO101

Structural inner frame made from Elliottis plywood, solid spruce, birch plywood and hardboard. Seat and back made from cut-to-size highly elastic polyurethane foam sheets wrapped in resinated wadding (Dacron). Seat cushions supported on elastic cords. Leg/armrest in natural varnished solid ash wood. Woolen protective pads for hardwood or polyethylene glides for hard flooring

Structure en Elliottis, sapin massif, multiplis de bouleau et isorel; Rembourrage assise et dossier en mousse de polyuréthane sectionné par un bloc hautement élastique et résine ouatée. Support assise avec sangles élastiques. Pied/accoudoir en frêne verni. Feutre de laine pour sols en bois ou de polyéthylène pour sols durs.

Gestell aus Elliottis, massiver Tanne, Birkensperholz und Faesit; Sitz- und Rückenpolster aus hochelastischem Polyurethanschaum, der aus Block- und Wattierungsharz geschnitten ist. Sitzhalterung mit elastischen Gurten. Füße und Armlehnen in lackierter Esche. Wollfilz für Holzböden oder Polyethylenleiter für harte Böden.

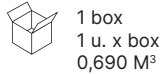

1 box
1 u. x box
0,690 M³



27,00
32,00





UPHOLSTERY / REVETEMENT / BEZUG

B01/B03	C01/C05	D02/D03	E01	P01
1895 PTS	1984 PTS	2044 PTS	2114 PTS	2473 PTS



UPHOLSTERY ON REQUEST / REVETEMENT SUR REQUETE / ÜBERZUG AUF ANFRAGE

D04/D06	E02/E03/E04	I01/I02	M01/M02/M03
2044 PTS	2114 PTS	2400 PTS	2549 PTS

BASE / BASE / GESTELL

	Oak varnished solid ash wood legs Piètement en frêne verni chêne Gestell aus Eiche hell-lackierter Esche	GAM10FK	=
	Walnut varnished solid ash wood legs Piètement en frêne verni noyer canaletto Gestell Esche Nußbaum Kanaletto lackiert	GAM10FN	=
	Elm varnished solid ash wood legs Piètement en frêne verni orme Gestell Esche Ulme lackiert	GAM10FO	=
	Anthracite varnished solid ash wood legs Piètement en frêne verni gris ombre Gestell Esche Dunkelgrau lackiert	GAM10FG	=

ON REQUEST ONLY / SUR REQUETE / AUF ANFRAGE

	Powder coated legs in a special finish, 3-unit minimum order Piètement en coloris spéciaux, à partir de 3 pièces Gestell nach Kundenwunsch, ab 3 Stück <small>Price on request for special varnish finishes / Pour vernis spécifiques, devis sur requête / Sonderlackfarben auf Anfrage</small>	VERN	+82 PTS
	Upholstery in fire retardant foam Rembourrage avec mousse non-feu Feuerfeste Gummipolsterung	IGNI	+42 PTS

Arco sofa 2-seater
Canapé Arco 2 places
Arco 2-Sitzer

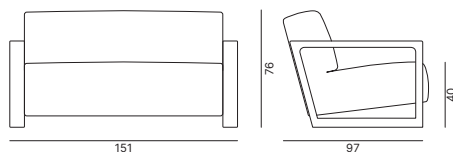

Cod. OARCO201

Structural inner frame made from Elliottis plywood, solid spruce, birch plywood and hardboard. Seat and back made from cut-to-size highly elastic polyurethane foam sheets wrapped in resinated wadding (Dacron). Seat cushions supported on elastic cords. Leg/armrest in natural varnished solid ash wood. Woolen protective pads for hardwood or polyethylene glides for hard flooring

Structure en Elliottis, sapin massif, multiplis de bouleau et isorel; Rembourrage assise et dossier en mousse de polyuréthane sectionnée par un bloc hautement élastique et résine ouatée. Support assise avec sangles élastiques. Pied/accoudoir en frêne verni. Feutre de laine pour sols en bois ou de polyéthylène pour sols durs.

Gestell aus Elliottis, massiver Tanne, Birkensperrholz und Faesit; Sitz- und Rückenpolster aus hochelastischem Polyurethanschaum, der aus Block- und Wattierungsharz geschnitten ist. Sitzhalterung mit elastischen Gurten. Füße und Armlehnen in lackierter Esche. Wollfilz für Holzböden oder Polyethylenleiter für harte Böden.

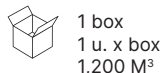

1 box
1 u. x box
1,200 M³



41,00
46,00





UPHOLSTERY / REVETEMENT / BEZUG

B01/B03	C01/C05	D02/D03	E01	P01
2294 PTS	2430 PTS	2522 PTS	2631 PTS	3187 PTS



UPHOLSTERY ON REQUEST / REVETEMENT SUR REQUETE / ÜBERZUG AUF ANFRAGE

D04/D06	E02/E03/E04	I01/I02	M01/M02/M03
2522 PTS	2631 PTS	3071 PTS	3300 PTS

BASE / BASE / GESTELL

	Oak varnished solid ash wood legs Piètement en frêne verni chêne Gestell aus Eiche hell-lackierter Esche	GAM10FK	=
	Walnut varnished solid ash wood legs Piètement en frêne verni noyer canaletto Gestell Esche Nußbaum Kanaletto lackiert	GAM10FN	=
	Elm varnished solid ash wood legs Piètement en frêne verni orme Gestell Esche Ulme lackiert	GAM10FO	=
	Anthracite varnished solid ash wood legs Piètement en frêne verni gris ombre Gestell Esche Dunkelgrau lackiert	GAM10FG	=

ON REQUEST ONLY / SUR REQUETE / AUF ANFRAGE

	Powder coated legs in a special finish, 3-unit minimum order Piètement en coloris spéciaux, à partir de 3 pièces Gestell nach Kundenwunsch, ab 3 Stück Price on request for special varnish finishes / Pour vernis spécifiques, devis sur requête / Sonderlackfarben auf Anfrage	VERN	+82 PTS
	Upholstery in fire retardant foam Rembourrage avec mousse non-feu Feuerfeste Gummipolsterung	IGNI	+77 PTS

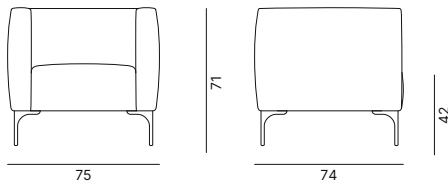

Cod. OARTE101

Inner frame made from spruce solid wood, MDF, chipboard and beech plywood; padding made from slab polyurethane foam wrapped in polyester fibre wadding, multiple levels of density and thickness; elastic dimensionally stable seat foam; brushed die-cast aluminium legs; polyethylene glides.

Structure en sapin massif, en multi-plis de hêtre et MDF; rembourrage en résine polyuréthanique expansée en plusieurs densités et épaisseurs; assise en polyuréthane indéformable à haute élasticité; pieds en alu brossé; patins en polyéthylène.

Stuhlkörper aus massiver Fichte, Spanplatte, mehrschichtigem Buchenholz und MDF; Polsterung aus Harz- und Polyurethanschaum, die durch Blöcke unterschiedlicher Dichten und Stärken geteilt sind; der Sitzteil besteht aus unverformbarem Polyurethan mit hoher Elastizität; Füße aus gebürstetem Aluminiumdruckguss; Stellfüße aus Polyethylen.



1 box
1 u. x box
0,440 M³



22,00
27,00

UPHOLSTERY / REVETEMENT / BEZUG

B01/B03	C01/C05	D02/D03	E01	P01
1147 PTS	1239 PTS	1285 PTS	1425 PTS	1591 PTS

UPHOLSTERY ON REQUEST / REVETEMENT SUR REQUETE / ÜBERZUG AUF ANFRAGE

D04/D06	E02/E03/E04	I01/I02	M01/M02/M03
1285 PTS	1425 PTS	1787 PTS	1976 PTS

ON REQUEST ONLY / SUR REQUETE / AUF ANFRAGE



Compliant with Class 1IM fire retardancy, B01, B03 and P01 upholstery
Homologué au feu classe 1IM, avec revêtement B01, B03 et P01
Brandschutzklasse 1IM, mit Polsterung in Kat. P01

OMOL

+50 PTS

Arte 2-seater sofa
Canapé Arte 2 places
Sofa Arte 2 Sitzer

Cod. OARTE201

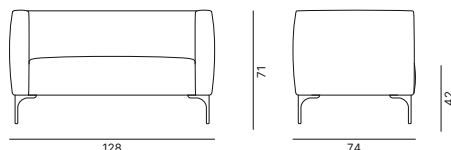

Inner frame made from spruce solid wood, MDF, chipboard and beech plywood; padding made from slab polyurethane foam wrapped in polyester fibre wadding, multiple levels of density and thickness; elastic dimensionally stable foam; brushed die-cast aluminium legs; polyethylene glides.

Structure en sapin massif, en multi-plis de hêtre et MDF; rembourrage en résine polyuréthanne expansée en plusieurs densités et épaisseurs; assise en polyuréthane indéformable à haute élasticité; pieds en alu brossé; patins en polyéthylène.

Stuhlkörper aus massiver Fichte, Spanplatte, mehrschichtigem Buchenholz und MDF; Polsterung aus Harz- und Polyurethanschaum, die durch Blöcke unterschiedlicher Dichten und Stärken geteilt sind; der Sitzteil besteht aus unverformbarem Polyurethan mit hoher Elastizität; Füße aus gebürstetem Aluminiumdruckguss; Stellfüße aus Polyethylen.

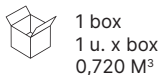

1 box
 1 u. x box
 0,720 M³



28,00
 35,00

UPHOLSTERY / REVETEMENT / BEZUG

B01/B03	C01/C05	D02/D03	E01	P01
1367 PTS	1483 PTS	1538 PTS	1712 PTS	1790 PTS

UPHOLSTERY ON REQUEST / REVETEMENT SUR REQUETE / ÜBERZUG AUF ANFRAGE

D04/D06	E02/E03/E04	I01/I02	M01/M02/M03
1538 PTS	1712 PTS	2162 PTS	2398 PTS

ON REQUEST ONLY / SUR REQUETE / AUF ANFRAGE



Compliant with Class 1IM fire retardancy, B01, B03 and P01 upholstery
 Homologué au feu classe 1IM, avec revêtement B01, B03 et P01
 Brandschutzklasse 1IM, mit Polsterung in Kat. P01

OMOL

+75 PTS

Cod. OARTE301

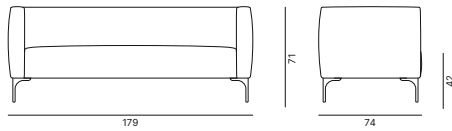

Inner frame made from spruce solid wood, MDF, chipboard and beech plywood; padding made from slab polyurethane foam wrapped in polyester fibre wadding, multiple levels of density and thickness; elastic dimensionally stable seat foam; brushed die-cast aluminium legs; polyethylene glides.

Structure en sapin massif, en multi-plis de hêtre et MDF; rembourrage en résine polyuréthanique expansée en plusieurs densités et épaisseurs; assise en polyuréthane indéformable à haute élasticité; pieds en alu brossé; patins en polyéthylène.

Stuhlkörper aus massiver Fichte, Spanplatte, mehrschichtigem Buchenholz und MDF; Polsterung aus Harz- und Polyurethanschaum, die durch Blöcke unterschiedlicher Dichten und Stärken geteilt sind; der Sitzteil besteht aus unverformbarem Polyurethan mit hoher Elastizität; Füße aus gebürstetem Aluminiumdruckguss; Stellfüße aus Polyethylen.

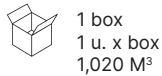

1 box
1 u. x box
1,020 M³



32,00
40,00

UPHOLSTERY / REVETEMENT / BEZUG

B01/B03	C01/C05	D02/D03	E01	P01
1726 PTS	1876 PTS	1949 PTS	2173 PTS	2427 PTS

UPHOLSTERY ON REQUEST / REVETEMENT SUR REQUETE / ÜBERZUG AUF ANFRAGE

D04/D06	E02/E03/E04	I01/I02	M01/M02/M03
1949 PTS	2173 PTS	2756 PTS	3059 PTS

ON REQUEST ONLY / SUR REQUETE / AUF ANFRAGE



Compliant with Class 1IM fire retardancy, B01, B03 and P01 upholstery
Homologué au feu classe 1IM, avec revêtement B01, B03 et P01
Brandschutzklasse 1IM, mit Polsterung in Kat. P01

OMOL

+105 PTS

Accord single armchair Fauteuil Accord Sessel Accord

Cod. OACCO101

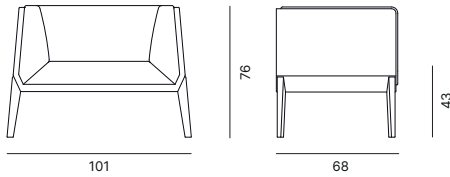

Inner frame made from steel tube and steel sheet metal, 25mm beech and poplar plywood; padding made from slab polyurethane foam wrapped in polyester fibre wadding, multiple levels of density and thickness; legs in steel or natural varnished beech wood with inner steel frame.

Structure en tube carré et tôle en acier, multi-plis de hêtre et peuplier ép. 25; rembourrage en résine polyuréthane indéformable à blocs de différentes densités et épaisseurs; pieds en acier ou hêtre massif verni naturel avec structure en acier.

Gestell aus Vierkantrohr und Stahlblech, mehrschichtiges Buchen- und Pappelholz, Stärke 25 mm; Polsterung aus Harz und unverformbarem Polyurethanschaum, der in Blöcke unterschiedlicher Dichte und Stärke geschnitten ist; Beine aus laminiertem Stahl oder naturlackierter massiver Buche mit Stahlverstärkung.

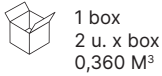

1 box
2 u. x box
0,360 M³



32,00
36,00

CUSHION UPHOLSTERY / REVETEMENT COUSSIN / KISSENBEZUG

B01/B03	C01/C05	D02/D03	E01	P01
1603 PTS	1709 PTS	1749 PTS	1855 PTS	2233 PTS

Full price: add prices of seat & back cushions upholstery + outer carcass upholstery + legs / Pour le prix total, il faut ajouter coussin, coque et base / Für den Gesamtpreis addieren Sie Sitzkissen, Sitz und Gestell

CUSHION UPHOLSTERY ON REQUEST / REVETEMENT COUSSIN SUR REQUETE / ÜBERZUG KISSEN AUF ANFRAGE

D04/D06	E02/E03/E04	I01/I02	M01/M02/M03
1749 PTS	1855 PTS	2186 PTS	2357 PTS

Full price: add prices of seat & back cushions upholstery + outer carcass upholstery + legs / Pour le prix total, il faut ajouter coussin, coque et base / Für den Gesamtpreis addieren Sie Sitzkissen, Sitz und Gestell

OUTER CARCASS UPHOLSTERY / REVETEMENT COQUE / SCHALENBEZUG

B01/B03	C01/C05	D02/D03	E01	P01
84 PTS	147 PTS	171 PTS	231 PTS	440 PTS





Full price: add prices of seat & back cushions upholstery + outer carcass upholstery + legs / Pour le prix total, il faut ajouter coussin, coque et base / Für den Gesamtpreis addieren Sie Sitzkissen, Sitz und Gestell

OUTER CARCASS UPHOLSTERY ON REQUEST / REVETEMENT COQUE SUR REQUETE / SCHALENBEZUG AUF ANFRAGE







D04/D06	E02/E03/E04	I01/I02	M01/M02/M03
171 PTS	231 PTS	426 PTS	526 PTS

Full price: add prices of seat & back cushions upholstery + outer carcass upholstery + legs / Pour le prix total, il faut ajouter coussin, coque et base / Für den Gesamtpreis addieren Sie Sitzkissen, Sitz und Gestell

BASE / BASE / GESTELL

	Oak varnished solid ash wood leg Piètement en frêne massif verni chêne FüÙe aus massiver Esche, Eiche hell lackiert	GAM08FK	+375 PTS
	Powder coated metal legs, white finish Piètement métal verni blanc Gestell Metall Weiß lackiert	GAM09VB	+590 PTS
	Powder coated metal legs, anthracite finish Piètement métal verni gris ombre Gestell Metall Dunkelgrau lackiert	GAM09GO	+590 PTS
	Chrome metal legs Piètement métal chromé Gestell Metall verchromt	GAM09CR	+656 PTS

ACCESSORIES / ACCESSOIRES / ZUBEHÖR

	Metal shelf, powder coated in white Table fixe en aluminium verni en blanc <i>Fester Tisch aus weiß lackiertem Aluminium</i>	TAV11VB	+186 PTS
	Magazine rack in white aluminium Porte revues en aluminium verni en blanc <i>Zeitungsständer aus weiß lackiertem Aluminium</i>	TAV12VB	+147 PTS
	Aluminium fixed side table powder coated in anthracite Table fixe en aluminium verni en gris ombre <i>Fester Tisch aus Aluminium dunkelgrau lackiert</i>	TAV11VO	+186 PTS
	Aluminium magazine rack powder coated in anthracite Porte revues en aluminium verni gris ombre <i>Zeitungsständer aus Aluminium dunkelgrau lackiert</i>	TAV12VO	+147 PTS
	USB charger on the right end side Kit USB côté droit noir <i>USB Kit rechts schwarz</i>	USB01NRD	+156 PTS
	USB charger on the left end side Kit USB côté gauche noir <i>USB Kit links schwarz</i>	USB01NRS	+156 PTS

ON REQUEST ONLY / SUR REQUETE / AUF ANFRAGE

	Gold powder coated frame Structure vernie or <i>Gestell Gold lackiert</i>	OR	+241 PTS
	Bronze powder coated frame Structure vernie bronze <i>Gestell Bronze lackiert</i>	BR	+241 PTS
	Corten powder coated frame Structure vernie corten <i>Gestell Corten lackiert</i>	CO	+241 PTS
	Upholstery in fire retardant foam Rembourrage avec mousse non-feu <i>Feuerfeste Gummipolsterung</i>	IGNI	+88 PTS

If you want to order the gold, bronze or corten painted frame, first select the powder coated metal legs and then add the supplement.

Pour avoir la structure en or, en bronze ou en corten, il est nécessaire de rajouter le supplement noté à côté de cela, au prix de la base en coated metal legs.

Der Aufpreis für das Gestell in Bronze, Gold oder Kupfer ergibt sich aus der Summe von dieser Position und dem Aufpreis vom Gestell Metall lackiert.

Accord 2-seater sofa Canapé Accord 2 places Sofa Accord, 2 Sitzer

Cod. OACCO201

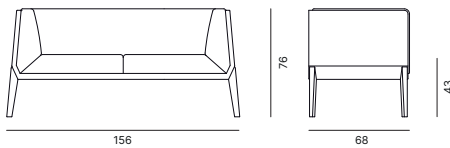

Inner frame made from steel tube and steel sheet metal, 25mm beech and poplar plywood; padding made from slab polyurethane foam wrapped in polyester fibre wadding, multiple levels of density and thickness; legs in steel or natural varnished beech wood with inner steel frame.

Structure en tube carré et tôle en acier, multi-plis de hêtre et peuplier ép. 25; rembourrage en résine polyuréthanique indéformable à blocs de différentes densités et épaisseurs; pieds en acier ou hêtre massif verni naturel avec structure en acier.

Gestell aus Vierkantrohr und Stahlblech, mehrschichtiges Buchen- und Pappelholz, Stärke 25 mm; Polsterung aus Harz und unverformbarem Polyurethanschaum, der in Blöcke unterschiedlicher Dichte und Stärke geschnitten ist; Beine aus laminiertem Stahl oder naturlackierter massiver Buche mit Stahlverstärkung.

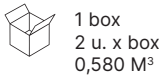

1 box
2 u. x box
0,580 M³



38,00
42,00

CUSHION UPHOLSTERY / REVETEMENT COUSSIN / KISSENBEZUG

B01/B03	C01/C05	D02/D03	E01	P01
2121 PTS	2262 PTS	2333 PTS	2453 PTS	2817 PTS

Full price: add prices of seat & back cushions upholstery + outer carcass upholstery + legs / Pour le prix total, il faut ajouter coussin, coque et base / Für den Gesamtpreis addieren Sie Sitzkissen, Sitz und Gestell

CUSHION UPHOLSTERY ON REQUEST / REVETEMENT COUSSIN SUR REQUETE / ÜBERZUG KISSEN AUF ANFRAGE

D04/D06	E02/E03/E04	I01/I02	M01/M02/M03
2333 PTS	2453 PTS	2887 PTS	3114 PTS

Full price: add prices of seat & back cushions upholstery + outer carcass upholstery + legs / Pour le prix total, il faut ajouter coussin, coque et base / Für den Gesamtpreis addieren Sie Sitzkissen, Sitz und Gestell

OUTER CARCASS UPHOLSTERY / REVETEMENT COQUE / SCHALENBEZUG

B01/B03	C01/C05	D02/D03	E01	P01
96 PTS	167 PTS	202 PTS	282 PTS	530 PTS



Full price: add prices of seat & back cushions upholstery + outer carcass upholstery + legs / Pour le prix total, il faut ajouter coussin, coque et base / Für den Gesamtpreis addieren Sie Sitzkissen, Sitz und Gestell

OUTER CARCASS UPHOLSTERY ON REQUEST / REVETEMENT COQUE SUR REQUETE / SCHALENBEZUG AUF ANFRAGE

D04/D06	E02/E03/E04	I01/I02	M01/M02/M03
202 PTS	282 PTS	524 PTS	650 PTS

Full price: add prices of seat & back cushions upholstery + outer carcass upholstery + legs / Pour le prix total, il faut ajouter coussin, coque et base / Für den Gesamtpreis addieren Sie Sitzkissen, Sitz und Gestell

BASE / BASE / GESTELL

	Oak varnished solid ash wood leg Piètement en frêne massif verni chêne FüÙe aus massiver Esche, Eiche hell lackiert	GAM08FK	+375 PTS
	Powder coated metal legs, white finish Piètement métal verni blanc Gestell Metall Weiß lackiert	GAM09VB	+590 PTS
	Powder coated metal legs, anthracite finish Piètement métal verni gris ombre Gestell Metall Dunkelgrau lackiert	GAM09GO	+590 PTS

BASE / BASE / GESTELL



Chrome metal legs
Piètement métal chromé
Gestell Metall verchromt

GAM09CR

+656 PTS

ACCESSORIES / ACCESSOIRES / ZUBEHÖR



Metal shelf, powder coated in white
Table fixe en aluminium verni en blanc
Fester Tisch aus weiß lackiertem Aluminium

TAV11VB

+186 PTS



Magazine rack in white aluminium
Porte revues en aluminium verni en blanc
Zeitungständer aus weiß lackiertem Aluminium

TAV12VB

+147 PTS



Aluminium fixed side table powder coated in anthracite
Table fixe en aluminium verni en gris ombre
Fester Tisch aus Aluminium dunkelgrau lackiert

TAV11VO

+186 PTS



Aluminium magazine rack powder coated in anthracite
Porte revues en aluminium verni gris ombre
Zeitungständer aus Aluminium dunkelgrau lackiert

TAV12VO

+147 PTS



USB charger on the right end side
Kit USB côté droit noir
USB Kit rechts schwarz

USB01NRD

+156 PTS



USB charger on the left end side
Kit USB côté gauche noir
USB Kit links schwarz

USB01NRS

+156 PTS

ON REQUEST ONLY / SUR REQUETE / AUF ANFRAGE



Gold powder coated frame
Structure vernie or
Gestell Gold lackiert

OR

+241 PTS



Bronze powder coated frame
Structure vernie bronze
Gestell Bronze lackiert

BR

+241 PTS



Corten powder coated frame
Structure vernie corten
Gestell Corten lackiert

CO

+241 PTS



Upholstery in fire retardant foam
Rembourrage avec mousse non-feu
Feuerfeste Gummipolsterung

IGNI

+100 PTS

If you want to order the gold, bronze or corten painted frame, first select the powder coated metal legs and then add the supplement.

Pour avoir la structure en or, en bronze ou en corten, il est nécessaire de rajouter le supplement noté à côté de cela, au prix de la base en coated metal legs.

Der Aufpreis für das Gestell in Bronze, Gold oder Kupfer ergibt sich aus der Summe von dieser Position und dem Aufpreis vom Gestell Metall lackiert.

Accord 3-seater sofa Canapé Accord 3 places Sofa Accord, 3 Sitzer

Cod. OACCO301

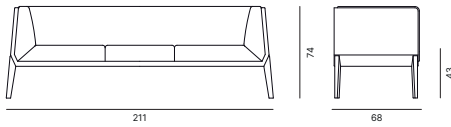

Inner frame made from steel tube and steel sheet metal, 25mm beech and poplar plywood; padding made from slab polyurethane foam wrapped in polyester fibre wadding, multiple levels of density and thickness; legs in steel or natural varnished beech wood with inner steel frame.

Structure en tube carré et tôle en acier, multi-plis de hêtre et peuplier ép. 25; rembourrage en résine polyuréthanique indéformable à blocs de différentes densités et épaisseurs; pieds en acier ou hêtre massif verni naturel avec structure en acier.

Gestell aus Vierkantrohr und Stahlblech, mehrschichtiges Buchen- und Pappelholz, Stärke 25 mm; Polsterung aus Harz und unverformbarem Polyurethanschaum, der in Blöcke unterschiedlicher Dichte und Stärke geschnitten ist; Beine aus laminiertem Stahl oder naturlackierter massiver Buche mit Stahlverstärkung.

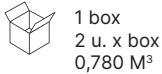

1 box
2 u. x box
0,780 M³



45,00
50,00

CUSHION UPHOLSTERY / REVETEMENT COUSSIN / KISSENBEZUG

B01/B03	C01/C05	D02/D03	E01	P01
2428 PTS	2610 PTS	2696 PTS	2852 PTS	3498 PTS

Full price: add prices of seat & back cushions upholstery + outer carcass upholstery + legs / Pour le prix total, il faut ajouter coussin, coque et base / Für den Gesamtpreis addieren Sie Sitzkissen, Sitz und Gestell

CUSHION UPHOLSTERY ON REQUEST / REVETEMENT COUSSIN SUR REQUETE / ÜBERZUG KISSEN AUF ANFRAGE

D04/D06	E02/E03/E04	I01/I02	M01/M02/M03
2696 PTS	2852 PTS	3407 PTS	3696 PTS

Full price: add prices of seat & back cushions upholstery + outer carcass upholstery + legs / Pour le prix total, il faut ajouter coussin, coque et base / Für den Gesamtpreis addieren Sie Sitzkissen, Sitz und Gestell

OUTER CARCASS UPHOLSTERY / REVETEMENT COQUE / SCHALENBEZUG

B01/B03	C01/C05	D02/D03	E01	P01
113 PTS	202 PTS	234 PTS	285 PTS	656 PTS



Full price: add prices of seat & back cushions upholstery + outer carcass upholstery + legs / Pour le prix total, il faut ajouter coussin, coque et base / Für den Gesamtpreis addieren Sie Sitzkissen, Sitz und Gestell

OUTER CARCASS UPHOLSTERY ON REQUEST / REVETEMENT COQUE SUR REQUETE / SCHALENBEZUG AUF ANFRAGE

D04/D06	E02/E03/E04	I01/I02	M01/M02/M03
234 PTS	285 PTS	510 PTS	626 PTS

Full price: add prices of seat & back cushions upholstery + outer carcass upholstery + legs / Pour le prix total, il faut ajouter coussin, coque et base / Für den Gesamtpreis addieren Sie Sitzkissen, Sitz und Gestell

BASE / BASE / GESTELL

	Oak varnished solid ash wood leg Piètement en frêne massif verni chêne FüÙe aus massiver Esche, Eiche hell lackiert	GAM08FK	+375 PTS
	Powder coated metal legs, white finish Piètement métal verni blanc Gestell Metall Weiß lackiert	GAM09VB	+590 PTS
	Powder coated metal legs, anthracite finish Piètement métal verni gris ombre Gestell Metall Dunkelgrau lackiert	GAM09GO	+590 PTS

BASE / BASE / GESTELL



Chrome metal legs
Piètement métal chromé
Gestell Metall verchromt

GAM09CR

+656 PTS

ACCESSORIES / ACCESSOIRES / ZUBEHÖR



Metal shelf, powder coated in white
Table fixe en aluminium verni en blanc
Fester Tisch aus weiß lackiertem Aluminium

TAV11VB

+186 PTS



Magazine rack in white aluminium
Porte revues en aluminium verni en blanc
Zeitungständer aus weiß lackiertem Aluminium

TAV12VB

+147 PTS



Aluminium fixed side table powder coated in anthracite
Table fixe en aluminium verni en gris ombre
Fester Tisch aus Aluminium dunkelgrau lackiert

TAV11VO

+186 PTS



Aluminium magazine rack powder coated in anthracite
Porte revues en aluminium verni gris ombre
Zeitungständer aus Aluminium dunkelgrau lackiert

TAV12VO

+147 PTS



USB charger on the right end side
Kit USB côté droit noir
USB Kit rechts schwarz

USB01NRD

+156 PTS



USB charger on the left end side
Kit USB côté gauche noir
USB Kit links schwarz

USB01NRS

+156 PTS

ON REQUEST ONLY / SUR REQUETE / AUF ANFRAGE



Gold powder coated frame
Structure vernie or
Gestell Gold lackiert

OR

+241 PTS



Bronze powder coated frame
Structure vernie bronze
Gestell Bronze lackiert

BR

+241 PTS



Corten powder coated frame
Structure vernie corten
Gestell Corten lackiert

CO

+241 PTS



Upholstery in fire retardant foam
Rembourrage avec mousse non-feu
Feuerfeste Gummipolsterung

IGNI

+154 PTS

If you want to order the gold, bronze or corten painted frame, first select the powder coated metal legs and then add the supplement.

Pour avoir la structure en or, en bronze ou en corten, il est nécessaire de rajouter le supplement noté à côté de cela, au prix de la base en coated metal legs.

Der Aufpreis für das Gestell in Bronze, Gold oder Kupfer ergibt sich aus der Summe von dieser Position und dem Aufpreis vom Gestell Metall lackiert.

Accord 2-seater high-back sofa

Canapé haut Accord 2 places

Sofa Accord, 2 Sitzler hoch

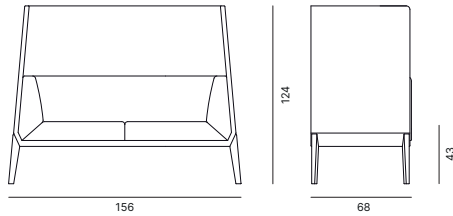

Cod. OACCO202

Inner frame made from steel tube and steel sheet metal, 25mm beech and poplar plywood; padding made from slab polyurethane foam wrapped in polyester fibre wadding, multiple levels of density and thickness; legs in steel or natural varnished beech wood with inner steel frame.

Structure en tube carré et tôle en acier, multi-plis de hêtre et peuplier ép. 25; rembourrage en résine polyuréthanique indéformable à blocs de différentes densités et épaisseurs; pieds en acier ou hêtre massif verni naturel avec structure en acier.

Gestell aus Vierkantrohr und Stahlblech, mehrschichtiges Buchen- und Pappelholz, Stärke 25 mm; Polsterung aus Harz und unverformbarem Polyurethanschaum, der in Blöcke unterschiedlicher Dichte und Stärke geschnitten ist; Beine aus laminiertem Stahl oder naturlackierter massiver Buche mit Stahlverstärkung.

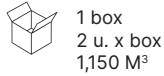

1 box
2 u. x box
1,150 M³



50,00
58,00

CUSHION UPHOLSTERY / REVETEMENT COUSSIN / KISSENBEZUG

B01/B03	C01/C05	D02/D03	E01	P01
2290 PTS	2430 PTS	2518 PTS	2622 PTS	3033 PTS

Full price: add prices of seat & back cushions upholstery + outer carcass upholstery + legs / Pour le prix total, il faut ajouter coussin, coque et base / Für den Gesamtpreis addieren Sie Sitzkissen, Sitz und Gestell

CUSHION UPHOLSTERY ON REQUEST / REVETEMENT COUSSIN SUR REQUETE / ÜBERZUG KISSEN AUF ANFRAGE

D04/D06	E02/E03/E04	I01/I02	M01/M02/M03
2518 PTS	2622 PTS	3057 PTS	3283 PTS

Full price: add prices of seat & back cushions upholstery + outer carcass upholstery + legs / Pour le prix total, il faut ajouter coussin, coque et base / Für den Gesamtpreis addieren Sie Sitzkissen, Sitz und Gestell

OUTER CARCASS UPHOLSTERY / REVETEMENT COQUE / SCHALENBEZUG

B01/B03	C01/C05	D02/D03	E01	P01
288 PTS	483 PTS	540 PTS	794 PTS	2043 PTS



Full price: add prices of seat & back cushions upholstery + outer carcass upholstery + legs / Pour le prix total, il faut ajouter coussin, coque et base / Für den Gesamtpreis addieren Sie Sitzkissen, Sitz und Gestell

OUTER CARCASS UPHOLSTERY ON REQUEST / REVETEMENT COQUE SUR REQUETE / SCHALENBEZUG AUF ANFRAGE

D04/D06	E02/E03/E04	I01/I02	M01/M02/M03
540 PTS	794 PTS	1453 PTS	1797 PTS

Full price: add prices of seat & back cushions upholstery + outer carcass upholstery + legs / Pour le prix total, il faut ajouter coussin, coque et base / Für den Gesamtpreis addieren Sie Sitzkissen, Sitz und Gestell

BASE / BASE / GESTELL

	Oak varnished solid ash wood leg Piètement en frêne massif verni chêne FüÙe aus massiver Esche, Eiche hell lackiert	GAM08FK	+375 PTS
	Powder coated metal legs, white finish Piètement métal verni blanc Gestell Metall Weiß lackiert	GAM09VB	+590 PTS
	Powder coated metal legs, anthracite finish Piètement métal verni gris ombre Gestell Metall Dunkelgrau lackiert	GAM09GO	+590 PTS

BASE / BASE / GESTELL



Chrome metal legs
 Piètement métal chromé
 Gestell Metall verchromt

GAM09CR

+656 PTS

ACCESSORIES / ACCESSOIRES / ZUBEHÖR



Magazine rack in white aluminium
 Porte revues en aluminium verni en blanc
 Zeitungsständer aus weiß lackiertem Aluminium

TAV12VB

+147 PTS



Aluminium magazine rack powder coated in anthracite
 Porte revues en aluminium verni gris ombre
 Zeitungsständer aus Aluminium dunkelgrau lackiert

TAV12VO

+147 PTS



USB charger on the right end side
 Kit USB côté droit noir
 USB Kit rechts schwarz

USB01NRD

+156 PTS



USB charger on the left end side
 Kit USB côté gauche noir
 USB Kit links schwarz

USB01NRS

+156 PTS

ON REQUEST ONLY / SUR REQUETE / AUF ANFRAGE



Gold powder coated frame
 Structure vernie or
 Gestell Gold lackiert

OR

+241 PTS



Bronze powder coated frame
 Structure vernie bronze
 Gestell Bronze lackiert

BR

+241 PTS



Corten powder coated frame
 Structure vernie corten
 Gestell Corten lackiert

CO

+241 PTS



Upholstery in fire retardant foam
 Rembourrage avec mousse non-feu
 Feuerfeste Gummipolsterung

IGNI

+174 PTS

If you want to order the gold, bronze or corten painted frame, first select the powder coated metal legs and then add the supplement.

Pour avoir la structure en or, en bronze ou en corten, il est nécessaire de rajouter le supplement noté à côté de cela, au prix de la base en coated metal legs.

Der Aufpreis für das Gestell in Bronze, Gold oder Kupfer ergibt sich aus der Summe von dieser Position und dem Aufpreis vom Gestell Metall lackiert.

Abbey single armchair

Fauteuil Abbey

Sessel Abbey

Cod. OABBE101

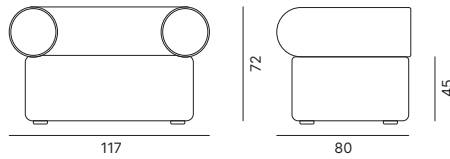

Structural inner frame made from spruce solid wood, beech plywood, masonite and steel; seat cushions supported on elastic cords; padding made from slab polyurethane foam wrapped in polyester fibre wadding; highly resilient dimensionally stable seat foam; solid beech wood feet.

Structure en sapin massif, en multi-plis de hêtre, acier; support assise par sangles élastiques; rembourrage en résine polyuréthanique et blocs de mousse en polyuréthane expansée; assise en polyuréthane indéformable; pieds en hêtre massif verni.

Stuhlkörper aus massiver Fichte, mehrschichtigem Buchenholz, Faesit, Stahl; Sitzverstärkung in Elastikgurten; Polsterung aus Harz und Polyurethanschaum in Blöcke geschnitten; Sitz aus unverformbarem Polyurethan; Füße aus lackierter massiver Buche.

 1 box
1 u. x box
0,730 M³

 24,00
29,00



UPHOLSTERY / REVETEMENT / BEZUG

B01/B03	C01/C05	D02/D03	E01	P01
2103 PTS	2203 PTS	2247 PTS	2398 PTS	3235 PTS

UPHOLSTERY ON REQUEST / REVETEMENT SUR REQUETE / ÜBERZUG AUF ANFRAGE

D04/D06	E02/E03/E04	I01/I02	M01/M02/M03
2247 PTS	2398 PTS	2781 PTS	2983 PTS

LEGS / PIETEMENT / FÜSSE

	Natural varnished beech wood Hêtre verni naturel Buche natur lackiert	PD3FA	=
	Anthracite varnished beech wood Hêtre verni anthracite Buche anthrazit lackiert	PD3AN	=

ON REQUEST ONLY / SUR REQUETE / AUF ANFRAGE

	Upholstery in fire retardant foam Rembourrage avec mousse non-feu Feuerfeste Gummipolsterung	IGNI	+204 PTS
---	---	------	----------

Cod. OABBE201

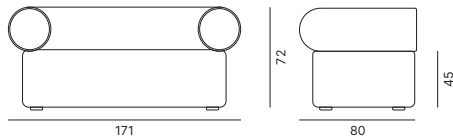

Structural inner frame made from spruce solid wood, beech plywood, masonite and steel; seat cushions supported on elastic cords; padding made from slab polyurethane foam wrapped in polyester fibre wadding; highly resilient dimensionally stable seat foam; solid beech wood feet.

Structure en sapin massif, en multi-plis de hêtre, acier; support assise par sangles élastiques; rembourrage en résine polyuréthanique et blocs de mousse en polyuréthane expansée; assise en polyuréthane indéformable; pieds en hêtre massif verni.

Stuhlkörper aus massiver Fichte, mehrschichtigem Buchenholz, Faesit, Stahl; Sitzverstärkung in Elastikgurten; Polsterung aus Harz und Polyurethanschaum in Blöcke geschnitten; Sitz aus unverformbarem Polyurethan; Füße aus lackierter massiver Buche.

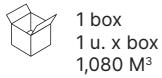

1 box
1 u. x box
1,080 M³



35,00
41,50



UPHOLSTERY / REVETEMENT / BEZUG

B01/B03	C01/C05	D02/D03	E01	P01
2962 PTS	3116 PTS	3172 PTS	3384 PTS	4580 PTS

UPHOLSTERY ON REQUEST / REVETEMENT SUR REQUETE / ÜBERZUG AUF ANFRAGE

D04/D06	E02/E03/E04	I01/I02	M01/M02/M03
3172 PTS	3384 PTS	3934 PTS	4220 PTS

LEGS / PIETEMENT / FÜSSE

	Natural varnished beech wood Hêtre verni naturel Buche natur lackiert	PD3FA	=
	Anthracite varnished beech wood Hêtre verni anthracite Buche anthrazit lackiert	PD3AN	=

ON REQUEST ONLY / SUR REQUETE / AUF ANFRAGE

	Upholstery in fire retardant foam Rembourrage avec mousse non-feu Feuerfeste Gummipolsterung	IGNI	+260 PTS
---	---	------	----------

Abbey puoff small

Pouf petit Abbey
Barhocker Abbey, klein

Cod. OABBEP01

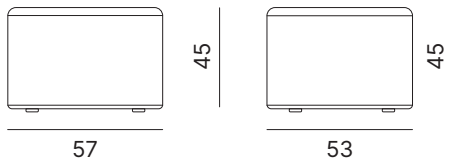

Structural inner frame made from spruce solid wood, beech plywood, masonite and steel; padding made of slab polyurethane foam wrapped in polyester fibre wadding; highly resilient dimensionally stable seat foam; solid beech wood feet.

Structure en sapin massif, en multi-plis de hêtre, acier; support assise par sangles élastiques; rembourrage en résine polyuréthanique et blocs de mousse en polyuréthane expansée; assise en polyuréthane indéformable; pieds en hêtre massif verni.

Stuhlkörper aus massiver Fichte, mehrschichtiger Buche, Spanplatte und Holz; Polsterung aus Harz- und Polyurethanschaum in Blöcke geschnitten; Sitz aus unverformbarem Polyurethan; Füße aus lackierter massiver Buche.

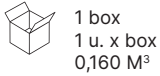

1 box
1 u. x box
0,160 M³



5,50
6,50



UPHOLSTERY / REVETEMENT / BEZUG

B01/B03	C01/C05	D02/D03	E01	P01
591 PTS	623 PTS	643 PTS	692 PTS	962 PTS

UPHOLSTERY ON REQUEST / REVETEMENT SUR REQUETE / ÜBERZUG AUF ANFRAGE

D04/D06	E02/E03/E04	I01/I02	M01/M02/M03
643 PTS	692 PTS	825 PTS	894 PTS

LEGS / PIETEMENT / FÜSSE

	Natural varnished beech wood Hêtre verni naturel Buche natur lackiert	PD3FA	=
	Anthracite varnished beech wood Hêtre verni anthracite Buche anthrazit lackiert	PD3AN	=

ON REQUEST ONLY / SUR REQUETE / AUF ANFRAGE

	Upholstery in fire retardant foam Rembourrage avec mousse non-feu Feuerfeste Gummipolsterung	IGNI	+27 PTS
---	---	------	---------

Cod. OABBEP02

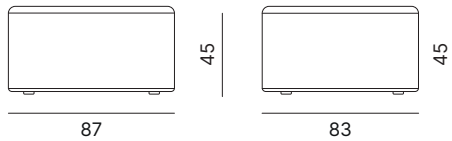

Structural inner frame made from spruce solid wood, beech plywood, masonite and steel; padding made of slab polyurethane foam wrapped in polyester fibre wadding; highly resilient dimensionally stable seat foam; solid beech wood feet.

Structure en sapin massif, en multi-plis de hêtre, acier; support assise par sangles élastiques; rembourrage en résine polyuréthanique et blocs de mousse en polyuréthane expansée; assise en polyuréthane indéformable; pieds en hêtre massif verni.

Stuhlkörper aus massiver Fichte, mehrschichtiger Buche, Spanplatte und Holz; Polsterung aus Harz- und Polyurethanschaum in Blöcke geschnitten; Sitz aus unverformbarem Polyurethan; Füße aus lackierter massiver Buche.

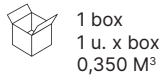

1 box
 1 u. x box
 0,350 M³



12,00
 15,00



UPHOLSTERY / REVETEMENT / BEZUG

B01/B03	C01/C05	D02/D03	E01	P01
939 PTS	986 PTS	1018 PTS	1082 PTS	1482 PTS

UPHOLSTERY ON REQUEST / REVETEMENT SUR REQUETE / ÜBERZUG AUF ANFRAGE

D04/D06	E02/E03/E04	I01/I02	M01/M02/M03
1018 PTS	1082 PTS	1269 PTS	1367 PTS

LEGS / PIETEMENT / FÜSSE

	Natural varnished beech wood Hêtre verni naturel Buche natur lackiert	PD3FA	=
	Anthracite varnished beech wood Hêtre verni anthracite Buche anthrazit lackiert	PD3AN	=

ON REQUEST ONLY / SUR REQUETE / AUF ANFRAGE

	Upholstery in fire retardant foam Rembourrage avec mousse non-feu Feuerfeste Gummipolsterung	IGNI	+40 PTS
---	---	------	---------

Ado single armchair

Fauteuil Ado

Sessel Ado

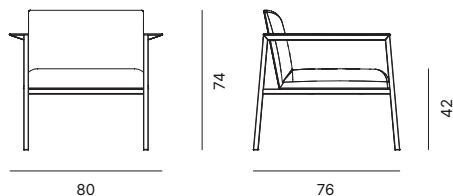

Cod. OADO1101

Beech plywood inner frame; 30×30×2mm epoxy powder coated steel outer frame; padding made from slab polyurethane foam wrapped in polyester fibre wadding; polyethylene glides.

Structure en multi-plis de hêtre; châssis en tube d'acier 30×30×2 verni à poudre époxy; rembourrage en résine polyuréthanique et blocs de mousse en polyuréthane expansée; patins en polyéthylène.

Stuhlkörper aus Buchensperrholz; Gestell aus Stahlrohr 30×30×2 mit Epoxidpulverlackierung; Polsterung aus Harz und Polyurethanschaum in Blöcke geschnitten; Füße aus Polyethylen.

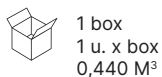

1 box
1 u. x box
0,440 M³



18,00
21,00

UPHOLSTERY / REVETEMENT / BEZUG

B01/B03	C01/C05	D02/D03	E01	P01
1191 PTS	1241 PTS	1268 PTS	1323 PTS	1589 PTS

UPHOLSTERY ON REQUEST / REVETEMENT SUR REQUETE / ÜBERZUG AUF ANFRAGE

D04/D06	E02/E03/E04	I01/I02	M01/M02/M03
1268 PTS	1323 PTS	1496 PTS	1587 PTS

FRAME / CADRE / GESTELL

	Powder coated frame in white Cadre verni blanc Gestell Weiß lackiert	FSB02	=
	Powder coated frame in anthracite Cadre verni gris ombre Gestell Dunkelgrau lackiert	FST02	=



ARMS / ACCOUDOIRS / ARMLEHNEN

	Armrests in oak varnished solid ash wood Accoudoirs en frêne massif verni chêne Armlehnen aus massiver Esche, Eiche hell lackiert	BRF14FK	=
	Armrests in walnut varnished solid ash wood Accoudoirs en frêne massif verni noyer canaletto Armlehnen aus massiver Esche Nußbaum Canaletto lackiert	BRF14FN	=
	Armrests in elm varnished solid ash wood Accoudoirs en frêne massif verni orme Armlehnen aus massiver Esche Ulme lackiert	BRF14FO	=
	Anthracite varnished solid ash wood arms Accoudoirs en frêne massif laqué gris ombre à pores ouverts Armlehnen aus massiver Esche Dunkelgrau offenporig lackiert	BRF14FG	+17 PTS

ON REQUEST ONLY / SUR REQUETE / AUF ANFRAGE

	Gold powder coated frame Structure vernie or Gestell Gold lackiert	OR	+191 PTS
--	---	----	----------

ON REQUEST ONLY / SUR REQUETE / AUF ANFRAGE

	Bronze powder coated frame Structure vernie bronze Gestell Bronze lackiert	BR	+191 PTS
	Corten powder coated frame Structure vernie corten Gestell Corten lackiert	CO	+191 PTS
	Powder coated frame in a special finish, 2-unit minimum order Cadre en coloris spéciaux, à partir de 2 pièces Gestell: Sonderlackierung nach Kundenwunsch, ab 2 Stück <small>Price on request for special varnish finishes / Pour vernis spécifiques, devis sur requête / Sonderlackfarben auf Anfrage</small>	VERN	+129 PTS

Ado 2-seater sofa
Canapé Ado 2 places
Sofa Ado 2 Sitzer

Cod. OADO1201

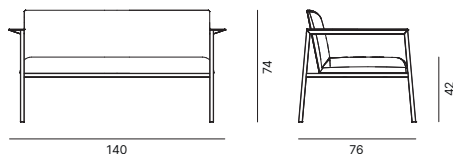

Beech plywood inner frame; 30×30×2mm epoxy powder coated steel outer frame; padding made from slab polyurethane foam wrapped in polyester fibre wadding; polyethylene glides.

Structure en multi-plis de hêtre; châssis en tube d'acier 30×30×2 verni à poudre époxy; rembourrage en résine polyuréthane et blocs de mousse en polyuréthane expansée; patins en polyéthylène.

Stuhlkörper aus Buchensperrholz; Gestell aus Stahlrohr 30×30×2 mit Epoxidpulverlackierung; Polsterung aus Harz und Polyurethanschaum in Blöcke geschnitten; Füße aus Polyethylen.

 1 box
 1 u. x box
 0,730 M³

 26,00
 31,00

UPHOLSTERY / REVETEMENT / BEZUG

B01/B03	C01/C05	D02/D03	E01	P01
1565 PTS	1622 PTS	1646 PTS	1732 PTS	1994 PTS

UPHOLSTERY ON REQUEST / REVETEMENT SUR REQUETE / ÜBERZUG AUF ANFRAGE

D04/D06	E02/E03/E04	I01/I02	M01/M02/M03
1646 PTS	1733 PTS	1949 PTS	2063 PTS

FRAME / CADRE / GESTELL

	Powder coated frame in white Cadre verni blanc Gestell Weiß lackiert	FSB02	=
	Powder coated frame in anthracite Cadre verni gris ombre Gestell Dunkelgrau lackiert	FST02	=



ARMS / ACCOUDOIRS / ARMLEHNEN

	Armrests in oak varnished solid ash wood Accoudoirs en frêne massif verni chêne Armlehnen aus massiver Esche, Eiche hell lackiert	BRF14FK	=
	Armrests in walnut varnished solid ash wood Accoudoirs en frêne massif verni noyer canaletto Armlehnen aus massiver Esche Nußbaum Canaletto lackiert	BRF14FN	=
	Armrests in elm varnished solid ash wood Accoudoirs en frêne massif verni orme Armlehnen aus massiver Esche Ulme lackiert	BRF14FO	=
	Anthracite varnished solid ash wood arms Accoudoirs en frêne massif laqué gris ombre à pores ouverts Armlehnen aus massiver Esche Dunkelgrau offenporig lackiert	BRF14FG	+17 PTS

ON REQUEST ONLY / SUR REQUETE / AUF ANFRAGE

	Gold powder coated frame Structure vernie or Gestell Gold lackiert	OR	+191 PTS
--	---	-----------	----------

ON REQUEST ONLY / SUR REQUETE / AUF ANFRAGE

	<p>Bronze powder coated frame Structure vernie bronze Gestell Bronze lackiert</p>	BR	+191 PTS
	<p>Corten powder coated frame Structure vernie corten Gestell Corten lackiert</p>	CO	+191 PTS
	<p>Powder coated frame in a special finish, 2-unit minimum order Cadre en coloris spéciaux, à partir de 2 pièces Gestell: Sonderlackierung nach Kundenwunsch, ab 2 Stück</p> <p><small>Price on request for special varnish finishes / Pour vernis spécifiques, devis sur requête / Sonderlackfarben auf Anfrage</small></p>	VERN	+129 PTS

Ado coffee table
Table basse Ado
Tisch Ado

Cod. OADO1T01

30mm Mfc top finished with 3mm Abs edges; 2mm 20×20mm epoxy powder coated steel frame; polyethylene glides.

Plateau en mélamine 30 mm avec chant en ABS ép. 3mm; cadre en tube d'acier 20×20×2 verni; patins en polyéthylène.

Platte aus 30 mm Melamin mit 3 mm starker ABS-Kante; Rahmen aus lackiertem Stahlrohr 20×20×2; Füße aus Polyethylen.

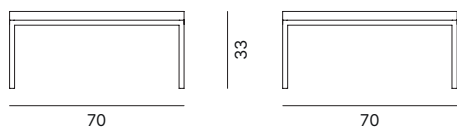

 1 box
1 u. x box
0,260 M³

 6,00
10,00

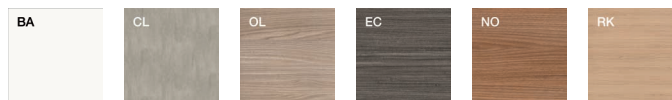

FINISH OPTIONS / FINITION / AUSFÜHRUNG

BA	CL	OL	EC	NO	RK
414 PTS	414 PTS	414 PTS	414 PTS	414 PTS	414 PTS

FRAME / CADRE / GESTELL

	Powder coated frame in white Cadre verni blanc Gestell Weiß lackiert	FSI10	=
	Powder coated frame in anthracite Cadre verni gris ombre Gestell Dunkelgrau lackiert	FST10	=

ON REQUEST ONLY / SUR REQUETE / AUF ANFRAGE

	Matt lacquered top Plateau laqué mat Matt lackierte Platte	LA	+64 PTS
	Gold powder coated frame Structure vernie or Gestell Gold lackiert	OR	+191 PTS
	Bronze powder coated frame Structure vernie bronze Gestell Bronze lackiert	BR	+191 PTS
	Corten powder coated frame Structure vernie corten Gestell Corten lackiert	CO	+191 PTS
	Powder coated frame in a special finish, 2-unit minimum order Cadre en coloris spéciaux, à partir de 2 pièces Gestell: Sonderlackierung nach Kundenwunsch, ab 2 Stück <small>Price on request for special varnish finishes / Pour vernis spécifiques, devis sur requête / Sonderlackfarben auf Anfrage</small>	VERN	+129 PTS

Cod. OASTR001

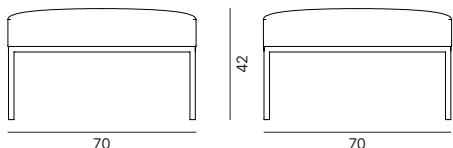

Inner frame made from spruce solid wood, MDF and chipboard; slab polyurethane foam; 20×20×2mm powder coated steel tube frame; polyethylene glides. Can be combined with the other Astro modules.

Structure en sapin massif, particules et MDF; rembourrage en blocs de mousse en polyuréthane expansée; cadre en tube d'acier 20×20×2 verni; patins en polyéthylène.

Stuhlkörper aus massiver Fichte, MDF, Spanplatte; Polsterung aus in Blöcke geschnittenem Polyurethanschaum; Gestell aus lackiertem Stahlrohr 20×20×2; Füße aus Polyethylen.

CATAS EN 16139 Level 1



1 box
1 u. x box
0,260 M³



7,00
11,00



UPHOLSTERY / REVETEMENT / BEZUG

B01/B03	C01/C05	D02/D03	E01	P01
471 PTS	499 PTS	512 PTS	551 PTS	724 PTS



UPHOLSTERY ON REQUEST / REVETEMENT SUR REQUETE / ÜBERZUG AUF ANFRAGE

D04/D06	E02/E03/E04	I01/I02	M01/M02/M03
512 PTS	551 PTS	658 PTS	714 PTS

FRAME / CADRE / GESTELL



	Powder coated frame in silver Cadre verni alu Gestell Aluminium lackiert	FSG10	=
	Powder coated frame in white Cadre verni blanc Gestell Weiß lackiert	FS110	=
	Powder coated frame in anthracite Cadre verni gris ombre Gestell Dunkelgrau lackiert	FST10	=
	Chrome frame Cadre chromé Verchromtes Gestell	FSC10	+78 PTS

ON REQUEST ONLY / SUR REQUETE / AUF ANFRAGE

	Gold powder coated frame Structure vernie or Gestell Gold lackiert	OR	+137 PTS
	Bronze powder coated frame Structure vernie bronze Gestell Bronze lackiert	BR	+137 PTS
	Corten powder coated frame Structure vernie corten Gestell Corten lackiert	CO	+137 PTS

Astro backless module
 Module pouf Astro
Element(e) Astro Hocker

ON REQUEST ONLY / SUR REQUETE / AUF ANFRAGE

	<p>Powder coated frame in a special finish, 2-unit minimum order Cadre en coloris spéciaux, à partir de 2 pièces Gestell: Sonderlackierung nach Kundenwunsch, ab 2 Stück</p> <p><small>Price on request for special varnish finishes / Pour vernis spécifiques, devis sur requête / Sonderlackfarben auf Anfrage</small></p>	<p>VERN</p>	<p>+88 PTS</p>
	<p>Upholstery in fire retardant foam Rembourrage avec mousse non-feu Feuerfeste Gummipolsterung</p>	<p>IGNI</p>	<p>+16 PTS</p>

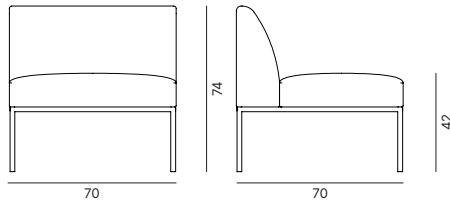

Cod. OASTR101

Inner frame made from spruce solid wood, MDF and chipboard; slab polyurethane foam; 20×20×2mm powder coated steel tube frame; polyethylene glides. Can be combined with the other Astro modules.

Structure en sapin massif, particules et MDF; rembourrage en blocs de mousse en polyuréthane expansée; cadre en tube d'acier 20×20×2 verni; patins en polyéthylène.

Stuhlkörper aus massiver Fichte, MDF, Spanplatte; Polsterung aus in Blöcke geschnittenem Polyurethanschaum; Gestell aus lackiertem Stahlrohr 20×20×2; Füße aus Polyethylen.

CATAS EN 16139 Level 1

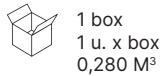

1 box
1 u. x box
0,280 M³



11,50
15,50





UPHOLSTERY / REVETEMENT / BEZUG

B01/B03	C01/C05	D02/D03	E01	P01
595 PTS	646 PTS	669 PTS	743 PTS	969 PTS



UPHOLSTERY ON REQUEST / REVETEMENT SUR REQUETE / ÜBERZUG AUF ANFRAGE

D04/D06	E02/E03/E04	I01/I02	M01/M02/M03
669 PTS	743 PTS	937 PTS	1038 PTS

FRAME / CADRE / GESTELL

	Powder coated frame in white Cadre verni blanc Gestell Weiß lackiert	FSI10	=
	Powder coated frame in anthracite Cadre verni gris ombre Gestell Dunkelgrau lackiert	FST10	=
	Powder coated frame in silver Cadre verni alu Gestell Aluminium lackiert	FSG10	=
	Chrome frame Cadre chromé Verchromtes Gestell	FSC10	+78 PTS

ON REQUEST ONLY / SUR REQUETE / AUF ANFRAGE

	Gold powder coated frame Structure vernie or Gestell Gold lackiert	OR	+137 PTS
	Bronze powder coated frame Structure vernie bronze Gestell Bronze lackiert	BR	+137 PTS
	Corten powder coated frame Structure vernie corten Gestell Corten lackiert	CO	+137 PTS

Astro straight module
 Module Astro 1 place
 Element(e) Astro 1 Sitzer

ON REQUEST ONLY / SUR REQUETE / AUF ANFRAGE

	<p>Powder coated frame in a special finish, 2-unit minimum order Cadre en coloris spéciaux, à partir de 2 pièces Gestell: Sonderlackierung nach Kundenwunsch, ab 2 Stück</p> <p><small>Price on request for special varnish finishes / Pour vernis spécifiques, devis sur requête / Sonderlackfarben auf Anfrage</small></p>	<p>VERN</p>	<p>+88 PTS</p>
	<p>Upholstery in fire retardant foam Rembourrage avec mousse non-feu Feuerfeste Gummipolsterung</p>	<p>IGNI</p>	<p>+25 PTS</p>

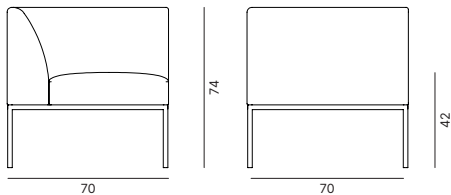

Cod. OASTRG01

Inner frame made from spruce solid wood, MDF and chipboard; slab polyurethane foam; 20×20×2mm powder coated steel tube frame; polyethylene glides. Can be combined with the other Astro modules.

Structure en sapin massif, particules et MDF; rembourrage en blocs de mousse en polyuréthane expansée; cadre en tube d'acier 20×20×2 verni; patins en polyéthylène.

Stuhlkörper aus massiver Fichte, MDF, Spanplatte; Polsterung aus in Blöcke geschnittenem Polyurethanschaum; Gestell aus lackiertem Stahlrohr 20×20×2; Füße aus Polyethylen.

CATAS EN 16139 Level 1



1 box
1 u. x box
0,280 M³



15,00
19,00



UPHOLSTERY / REVETEMENT / BEZUG

B01/B03	C01/C05	D02/D03	E01	P01
755 PTS	809 PTS	835 PTS	909 PTS	1247 PTS



UPHOLSTERY ON REQUEST / REVETEMENT SUR REQUETE / ÜBERZUG AUF ANFRAGE

D04/D06	E02/E03/E04	I01/I02	M01/M02/M03
835 PTS	909 PTS	1112 PTS	1217 PTS

FRAME / CADRE / GESTELL



	Powder coated frame in white Cadre verni blanc Gestell Weiß lackiert	FSI10	=
	Powder coated frame in anthracite Cadre verni gris ombre Gestell Dunkelgrau lackiert	FST10	=
	Powder coated frame in silver Cadre verni alu Gestell Aluminium lackiert	FSG10	=
	Chrome frame Cadre chromé Verchromtes Gestell	FSC10	+78 PTS

ON REQUEST ONLY / SUR REQUETE / AUF ANFRAGE

	Gold powder coated frame Structure vernie or Gestell Gold lackiert	OR	+137 PTS
	Bronze powder coated frame Structure vernie bronze Gestell Bronze lackiert	BR	+137 PTS
	Corten powder coated frame Structure vernie corten Gestell Corten lackiert	CO	+137 PTS

Astro corner module
 Module d'angle Astro
 Element(e) Astro Eckelement

ON REQUEST ONLY / SUR REQUETE / AUF ANFRAGE

	<p>Powder coated frame in a special finish, 2-unit minimum order Cadre en coloris spéciaux, à partir de 2 pièces Gestell: Sonderlackierung nach Kundenwunsch, ab 2 Stück</p> <p><small>Price on request for special varnish finishes / Pour vernis spécifiques, devis sur requête / Sonderlackfarben auf Anfrage</small></p>	<p>VERN</p>	<p>+88 PTS</p>
	<p>Upholstery in fire retardant foam Rembourrage avec mousse non-feu Feuerfeste Gummipolsterung</p>	<p>IGNI</p>	<p>+31 PTS</p>

Cod. OASTRT01

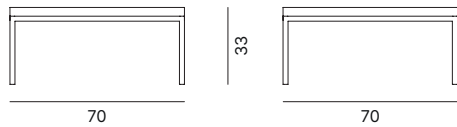

30mm Mfc top finished with 3mm Abs edges; 2mm 20×20mm epoxy powder coated steel frame; polyethylene glides.

Plateau en mélamine 30 mm avec chant en ABS ép. 3mm; cadre en tube d'acier 20×20×2 verni; patins en polyéthylène.

Platte aus 30 mm Melamin mit 3 mm starker ABS-Kante; Rahmen aus lackiertem Stahlrohr 20×20×2; Füße aus Polyethylen.





 1 box
1 u. x box
0,260 M³

 6,00
10,00

FINISH OPTIONS / FINITION / AUSFÜHRUNG

BA	CL	EC	OL	NO	RK
414 PTS	414 PTS	414 PTS	414 PTS	414 PTS	414 PTS

FRAME / CADRE / GESTELL

	Powder coated frame in white Cadre verni blanc Gestell Weiß lackiert	FSI10	=
	Powder coated frame in anthracite Cadre verni gris ombre Gestell Dunkelgrau lackiert	FST10	=
	Powder coated frame in silver Cadre verni alu Gestell Aluminium lackiert	FSG10	=
	Chrome frame Cadre chromé Verchromtes Gestell	FSC10	+78 PTS

ON REQUEST ONLY / SUR REQUETE / AUF ANFRAGE

	Matt lacquered top Plateau laqué mat Matt lackierte Platte	LA	+64 PTS
	Gold powder coated frame Structure vernie or Gestell Gold lackiert	OR	+137 PTS
	Bronze powder coated frame Structure vernie bronze Gestell Bronze lackiert	BR	+137 PTS
	Corten powder coated frame Structure vernie corten Gestell Corten lackiert	CO	+137 PTS
	Powder coated frame in a special finish, 2-unit minimum order Cadre en coloris spéciaux, à partir de 2 pièces Gestell: Sonderlackierung nach Kundenwunsch, ab 2 Stück <small>Price on request for special varnish finishes / Pour vernis spécifiques, devis sur requête / Sonderlackfarben auf Anfrage</small>	VERN	+88 PTS

Curved shaped backless Astro module

Composable Astro courbe, pouf

Gebogenes Element Astro, Hocker

ASTRO TWIST

Cod. OASTC001

Inner frame made from birch plywood, MDF and chipboard; slab polyurethane foam; 20×20×2mm powder coated steel tube frame; polyethylene glides. Can be combined with the other Astro modules.

Structure en bouleau, particules et MDF; rembourrage en blocs de mousse en polyuréthane expansée; cadre en tube d'acier 20×20×2 verni; patins en polyéthylène.

Stuhlkörper aus massiver Birke, MDF, Spanplatte; Polsterung aus in Blöcke geschnittenem Polyurethanschaum; Gestell aus lackiertem Stahlrohr 20×20×2; Füße aus Polyethylen.

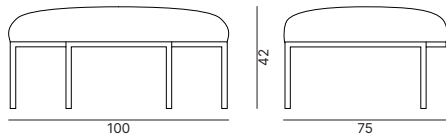

CATAS EN 16139 Level 1

 1 box
1 u. x box
0,360 M³

 10,00
14,00

UPHOLSTERY / REVETEMENT / BEZUG

B01/B03	C01/C05	D02/D03	E01	P01
608 PTS	640 PTS	654 PTS	700 PTS	846 PTS



UPHOLSTERY ON REQUEST / REVETEMENT SUR REQUETE / ÜBERZUG AUF ANFRAGE

D04/D06	E02/E03/E04	I01/I02	M01/M02/M03
654 PTS	700 PTS	822 PTS	884 PTS



FRAME / CADRE / GESTELL

	Powder coated frame in white Cadre verni blanc Gestell Weiß lackiert	FSB31	=
	Powder coated frame in anthracite Cadre verni gris ombre Gestell Dunkelgrau lackiert	FST28	=
	Powder coated frame in silver Cadre verni alu Gestell Aluminium lackiert	FSG28	=
	Chrome frame Cadre chromé Verchromtes Gestell	FSC36	+94 PTS

ON REQUEST ONLY / SUR REQUETE / AUF ANFRAGE

	Gold powder coated frame Structure vernie or Gestell Gold lackiert	OR	+137 PTS
	Bronze powder coated frame Structure vernie bronze Gestell Bronze lackiert	BR	+137 PTS
	Corten powder coated frame Structure vernie corten Gestell Corten lackiert	CO	+137 PTS

ON REQUEST ONLY / SUR REQUETE / AUF ANFRAGE

	<p>Powder coated frame in a special finish, 2-unit minimum order Cadre en coloris spéciaux, à partir de 2 pièces Gestell: Sonderlackierung nach Kundenwunsch, ab 2 Stück</p>	<p>VERN</p>	<p>+88 PTS</p>
<p><small>Price on request for special varnish finishes / Pour vernis spécifiques, devis sur requête / Sonderlackfarben auf Anfrage</small></p>			
	<p>Upholstery in fire retardant foam Rembourrage avec mousse non-feu Feuerfeste Gummipolsterung</p>	<p>IGNI</p>	<p>+14 PTS</p>

Curved shaped Astro module, concave

Composable Astro courbe, 1 place concave

Gebogenes Element Astro, 1 Sitzler konkav

Cod. OASTC101

Inner frame made from birch plywood, MDF and chipboard; slab polyurethane foam; 20×20×2mm powder coated steel tube frame; polyethylene glides. Can be combined with the other Astro modules.

Structure en bouleau, particules et MDF; rembourrage en blocs de mousse en polyuréthane expansée; cadre en tube d'acier 20×20×2 verni; patins en polyéthylène.

Stuhlkörper aus massiver Birke, MDF, Spanplatte; Polsterung aus in Blöcke geschnittenem Polyurethanschaum; Gestell aus lackiertem Stahlrohr 20×20×2; Füße aus Polyethylen.

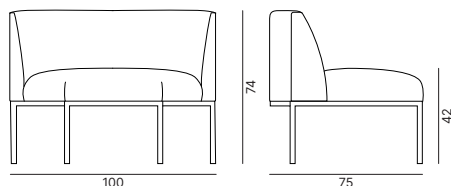

CATAS EN 16139 Level 1

 1 box
1 u. x box
0,360 M³

 15,00
19,00





UPHOLSTERY / REVETEMENT / BEZUG

B01/B03	C01/C05	D02/D03	E01	P01
773 PTS	831 PTS	862 PTS	937 PTS	1027 PTS



UPHOLSTERY ON REQUEST / REVETEMENT SUR REQUETE / ÜBERZUG AUF ANFRAGE

D04/D06	E02/E03/E04	I01/I02	M01/M02/M03
862 PTS	937 PTS	1152 PTS	1264 PTS

FRAME / CADRE / GESTELL

	Powder coated frame in white Cadre verni blanc Gestell Weiß lackiert	FSB31	=
	Powder coated frame in anthracite Cadre verni gris ombre Gestell Dunkelgrau lackiert	FST28	=
	Powder coated frame in silver Cadre verni alu Gestell Aluminium lackiert	FSG28	=
	Chrome frame Cadre chromé Verchromtes Gestell	FSC36	+94 PTS

ON REQUEST ONLY / SUR REQUETE / AUF ANFRAGE

	Gold powder coated frame Structure vernie or Gestell Gold lackiert	OR	+137 PTS
	Bronze powder coated frame Structure vernie bronze Gestell Bronze lackiert	BR	+137 PTS
	Corten powder coated frame Structure vernie corten Gestell Corten lackiert	CO	+137 PTS

ASTRO TWIST

Curved shaped Astro module, concave
Composable Astro courbe, 1 place concave
Gebogenes Element Astro, 1 Sitzler konkav

ON REQUEST ONLY / SUR REQUETE / AUF ANFRAGE



Powder coated frame in a special finish, 2-unit minimum order

Cadre en coloris spéciaux, à partir de 2 pièces
Gestell: Sonderlackierung nach Kundenwunsch, ab 2 Stück

Price on request for special varnish finishes / Pour vernis spécifiques, devis sur requête / Sonderlackfarben auf Anfrage

VERN

+88 PTS



Upholstery in fire retardant foam

Rembourrage avec mousse non-feu
Feuerfeste Gummipolsterung

IGNI

+19 PTS

Curved shaped Astro module, convex
 Composable Astro courbe, 1 place convexe
 Gebogenes Element Astro, 1 Sitzler konvex

ASTRO TWIST

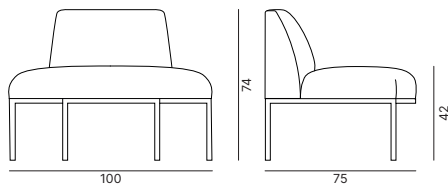

Cod. OASTC102

Inner frame made from birch plywood, MDF and chipboard; slab polyurethane foam; 20×20×2mm powder coated steel tube frame; polyethylene glides. Can be combined with the other Astro modules.

Structure en bouleau, particules et MDF; rembourrage en blocs de mousse en polyuréthane expansée; cadre en tube d'acier 20×20×2 verni; patins en polyéthylène.

Stuhlkörper aus massiver Birke, MDF, Spanplatte; Polsterung aus in Blöcke geschnittenem Polyurethanschaum; Gestell aus lackiertem Stahlrohr 20×20×2; Füße aus Polyethylen.

CATAS EN 16139 Level 1

1 box
 1 u. x box
 0,360 M³

14,00
 18,00

UPHOLSTERY / REVETEMENT / BEZUG

B01/B03	C01/C05	D02/D03	E01	P01
745 PTS	789 PTS	811 PTS	871 PTS	988 PTS

UPHOLSTERY ON REQUEST / REVETEMENT SUR REQUETE / ÜBERZUG AUF ANFRAGE

D04/D06	E02/E03/E04	I01/I02	M01/M02/M03
811 PTS	871 PTS	1036 PTS	1123 PTS

FRAME / CADRE / GESTELL

	Powder coated frame in white Cadre verni blanc Gestell Weiß lackiert	FSB31	=
	Powder coated frame in anthracite Cadre verni gris ombre Gestell Dunkelgrau lackiert	FST28	=
	Powder coated frame in silver Cadre verni alu Gestell Aluminium lackiert	FSG28	=
	Chrome frame Cadre chromé Verchromtes Gestell	FSC36	+94 PTS

ON REQUEST ONLY / SUR REQUETE / AUF ANFRAGE

	Gold powder coated frame Structure vernie or Gestell Gold lackiert	OR	+137 PTS
	Bronze powder coated frame Structure vernie bronze Gestell Bronze lackiert	BR	+137 PTS
	Corten powder coated frame Structure vernie corten Gestell Corten lackiert	CO	+137 PTS

ASTRO TWIST

Curved shaped Astro module, convex
Composable Astro courbe, 1 place convexe
Gebogenes Element Astro, 1 Sitzler konvex

ON REQUEST ONLY / SUR REQUETE / AUF ANFRAGE



Powder coated frame in a special finish, 2-unit minimum order

Cadre en coloris spéciaux, à partir de 2 pièces

Gestell: Sonderlackierung nach Kundenwunsch, ab 2 Stück

Price on request for special varnish finishes / Pour vernis spécifiques, devis sur requête / Sonderlackfarben auf Anfrage

VERN

+88 PTS



Upholstery in fire retardant foam

Rembourrage avec mousse non-feu

Feuerfeste Gummipolsterung

IGNI

+19 PTS

Astro Table
 Table basse Astro
 Element(e) Astro Tisch

ASTRO TWIST

Cod. OASTCT01

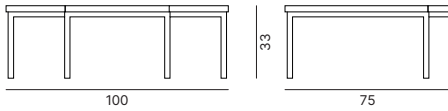

30mm Mfc top finished with 3mm Abs edges; 2mm 20×20mm epoxy powder coated steel frame; polyethylene glides.

Plateau en mélamine 30 mm avec chant en ABS ép. 3mm; cadre en tube d'acier 20×20×2 verni; patins en polyéthylène.

Platte aus 30 mm Melamin mit 3 mm starker ABS-Kante; Rahmen aus lackiertem Stahlrohr 20×20×2; Füße aus Polyethylen.

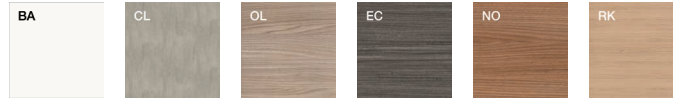

1 box
 1 u. x box
 0,360 M³

16,00
 20,00

FINISH OPTIONS / FINITION / AUSFÜHRUNG

BA	CL	EC	OL	NO	RK
442 PTS	442 PTS	442 PTS	442 PTS	442 PTS	442 PTS

FRAME / CADRE / GESTELL

	Powder coated frame in white Cadre verni blanc Gestell Weiß lackiert	FSB31	=
	Powder coated frame in anthracite Cadre verni gris ombre Gestell Dunkelgrau lackiert	FST28	=
	Powder coated frame in silver Cadre verni alu Gestell Aluminium lackiert	FSG28	=
	Chrome frame Cadre chromé Verchromtes Gestell	FSC36	+94 PTS

ON REQUEST ONLY / SUR REQUETE / AUF ANFRAGE

	Matt lacquered top Plateau laqué mat Matt lackierte Platte	LA	+98 PTS
	Gold powder coated frame Structure vernie or Gestell Gold lackiert	OR	+137 PTS
	Bronze powder coated frame Structure vernie bronze Gestell Bronze lackiert	BR	+137 PTS
	Corten powder coated frame Structure vernie corten Gestell Corten lackiert	CO	+137 PTS
	Powder coated frame in a special finish, 2-unit minimum order Cadre en coloris spéciaux, à partir de 2 pièces Gestell: Sonderlackierung nach Kundenwunsch, ab 2 Stück <small>Price on request for special varnish finishes / Pour vernis spécifiques, devis sur requête / Sonderlackfarben auf Anfrage</small>	VERN	+88 PTS

GUIDE TO ORDER THE PRODUCT
GUÍA PARA PEDIR EL PRODUCTO
ANLEITUNG ZUR AUFTRAGSERTEILUNG

01. CHOOSE ONE OF THE AVAILABLE STRUCTURES

ELIJA ENTRE LAS ESTRUCTURAS DISPONIBLES
 UNTER DEN VERFÜGBAREN GESTELLEN WÄHLEN

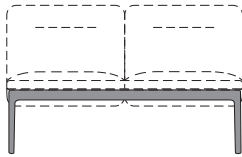

2 seats structure
 Structure 2 places
 Gestell 2-Sitzer

3 seats structure
 Structure 3 places
 Gestell 3-Sitzer

4 seats structure
 Structure 4 places
 Gestell 4-Sitzer

02. CHOOSE ADD-ONS TO COMPLETE THE STRUCTURE

ELIJA LOS MÓDULOS ADICIONALES PARA COMPLETAR LA ESTRUCTURA
 DIE BAUMODULE WÄHLEN

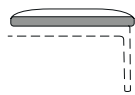

Armony Pouf
 Pouf Armony
 Barhocker Armony

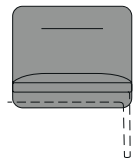

Armony Seat
 Assise Armony
 Sitz Armony

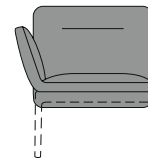

Seat with right armrest
 Assise avec accoudoir à droite
 Sitz mit rechter Armstütze

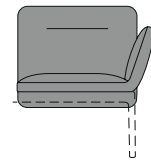

Seat with left armrest
 Assise avec accoudoir à gauche
 Sitz mit linker Armstütze

03. CHOOSE ACCESSORY ELEMENTS

ELIJA LOS ELEMENTOS ADICIONALES
 DAS ZUBEHÖR, FALLS GEWÜNSCHT, HINZUFÜGEN

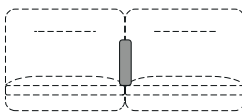

Central armrest
 Accoudoir Armony
 Armstütze Armony

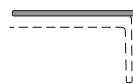

Side table
 Petit table
 Tisch

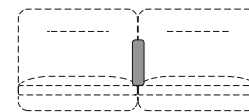

Central armrest with table
 Accoudoir Armony avec table
 Armstütze Armony mit Tisch

NB.

in the composition it is necessary to use for the different modules the same coating finishes. it is not possible to create a composition where the elements have different fabrics.

En la composición, deben utilizarse los mismos acabados de tejido para los distintos módulos.
 No es posible crear una composición en la que los elementos tengan tejidos diferentes.

Wichtig: in einer Komposition müssen alle Farben gleich sein. Es ist nicht möglich, verschiedene Farben zu kombinieren.

2 seats structure Structure 2 places Gestell 2-Sitzer

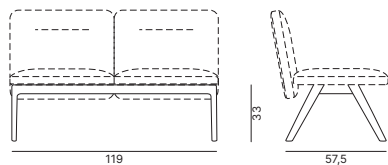

Cod. OARMO201



Legs in polished die-cast aluminium; adjustable feet; double tubular steel beam with squared section, varnished.

Piètement en aluminium brillant; patins réglables; double poutre en tube d'acier à section carrée, vernie.

Beine aus glänzendem Aluminiumdruckguss; verstellbare Füße; doppelte Traverse aus Stahlrohr mit quadratischem Querschnitt, lackiert.

 2 box
1 u. x box
0,073 M³

 13,50
15,50

BASE / BASE			
	Polished brushed aluminium base, shadow grey beam Base en aluminium brossé poli, poutre en gris ombre Gestell Alu poliert gebürstet, Traverse Dunkelgrau	STR08AL	762 PTS
	Shadow grey painted base, shadow grey beam Base vernie gris ombre, poutre en gris ombre Gestell lackiert Dunkelgrau, Traverse Dunkelgrau	STR08VO	762 PTS

TO COMPLETE THE COMPOSITION SEE THE SECTION "ADDITIONAL MODULES", P. 212-213

TO FURTHER ENRICH THE COMPOSITION, SEE THE SECTION "ACCESSORY ELEMENTS", P. 214

PARA COMPLETAR LA COMPOSICIÓN, VÉASE LA SECCIÓN "MÓDULOS ADICIONALES", PÁGINA 212-213

PARA AMPLIAR AÚN MÁS LA COMPOSICIÓN, CONSULTE LA SECCIÓN "ELEMENTOS ADICIONALES", PÁGINA 214

UM DIE KOMPOSITION ZU ERGÄNZEN, BITTE DIE BAUMODULE AUF SEITE 212-213 WÄHLEN

UM EVENTUELL ZUBEHÖR HINZUZUFÜGEN, BITTE UNTER „ZUBEHÖR“ DIE PASSENDEN WÄHLEN, SEITE 214

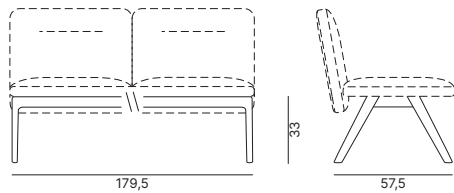

Cod. OARMO301



Legs in polished die-cast aluminium; adjustable feet; double tubular steel beam with squared section, varnished.

Piètement en aluminium brillant; patins réglables; double poutre en tube d'acier à section carrée, vernie.
Beine aus glänzendem Aluminiumdruckguss; verstellbare Füße; doppelte Traverse aus Stahlrohr mit quadratischem Querschnitt, lackiert.

 2 box
1 u. x box
0,082 M³

 16,00
18,20

BASE / BASE

	<p>Polished brushed aluminium base, shadow grey beam Base en aluminium brossé poli, poutre en gris ombre <i>Gestell Alu poliert gebürstet, Traverse Dunkelgrau</i></p>	STR08AL	906 PTS
	<p>Shadow grey painted base, shadow grey beam Base vernie gris ombre, poutre en gris ombre <i>Gestell lackiert Dunkelgrau, Traverse Dunkelgrau</i></p>	STR08VO	906 PTS

TO COMPLETE THE COMPOSITION SEE THE SECTION "ADDITIONAL MODULES", P. 212-213

TO FURTHER ENRICH THE COMPOSITION, SEE THE SECTION "ACCESSORY ELEMENTS", P. 214

PARA COMPLETAR LA COMPOSICIÓN, VÉASE LA SECCIÓN "MÓDULOS ADICIONALES", PÁGINA 212-213

PARA AMPLIAR AÚN MÁS LA COMPOSICIÓN, CONSULTE LA SECCIÓN "ELEMENTOS ADICIONALES", PÁGINA 214

UM DIE KOMPOSITION ZU ERGÄNZEN, BITTE DIE BAUMODULE AUF SEITE 212-213 WÄHLEN

UM EVENTUELL ZUBEHÖR HINZUZUFÜGEN, BITTE UNTER „ZUBEHÖR“ DIE PASSENDEN WÄHLEN, SEITE 214

4 seats structure Structure 4 places Gestell 4-Sitzer

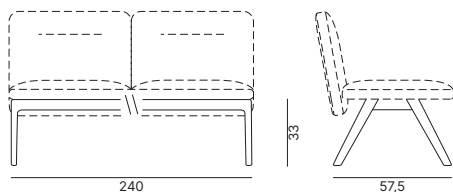



Cod. OARMO401

Legs in polished die-cast aluminium; adjustable feet; double tubular steel beam with squared section, varnished.

Piètement en aluminium brillant; patins réglables; double poutre en tube d'acier à section carrée, vernie.
Beine aus glänzendem Aluminiumdruckguss; verstellbare Füße; doppelte Traverse aus Stahlrohr mit quadratischem Querschnitt, lackiert.

 2 box
1 u. x box
0,090 M³

 18,50
21,00

BASE / BASE			
	Polished brushed aluminium base, shadow grey beam Base en aluminium brossé poli, poutre en gris ombre Gestell Alu poliert gebürstet, Traverse Dunkelgrau	STR08AL	957 PTS
	Shadow grey painted base , shadow grey beam Base vernie gris ombre, poutre en gris ombre Gestell lackiert Dunkelgrau, Traverse Dunkelgrau	STR08VO	957 PTS

TO COMPLETE THE COMPOSITION SEE THE SECTION "ADDITIONAL MODULES", P. 212-213

TO FURTHER ENRICH THE COMPOSITION, SEE THE SECTION "ACCESSORY ELEMENTS", P. 214

PARA COMPLETAR LA COMPOSICIÓN, VÉASE LA SECCIÓN "MÓDULOS ADICIONALES", PÁGINA 212-213

PARA AMPLIAR AÚN MÁS LA COMPOSICIÓN, CONSULTE LA SECCIÓN "ELEMENTOS ADICIONALES", PÁGINA 214

UM DIE KOMPOSITION ZU ERGÄNZEN, BITTE DIE BAUMODULE AUF SEITE 212-213 WÄHLEN

UM EVENTUELL ZUBEHÖR HINZUZUFÜGEN, BITTE UNTER „ZUBEHÖR“ DIE PASSENDEN WÄHLEN, SEITE 214

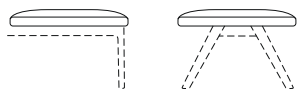

1 box
1 u. x box
0,065 M³



4,8
6

Armony Pouf

Pouf Armony
Barhocker Armony

Cod. POU01

Injection moulded polyurethane foam seat padding with beech plywood frame.
Rembourrage en mousse de polyuréthane expansée avec structure en multiplis de hêtre.
Polsterung aus geschäumtem Polyurethanschaum mit mehrschichtigem Buchenholz.

UPHOLSTERY / REVETEMENT / BEZUG

B01/B03	C05	D02/D03	E01	P01
271 PTS	285 PTS	297 PTS	322 PTS	401 PTS

UPHOLSTERY ON REQUEST / REVETEMENT SUR REQUETE / ÜBERZUG AUF ANFRAGE

D04/D06	E02/E03/E04	I01/I02	M01/M02/M03
297 PTS	322 PTS	388 PTS	423 PTS

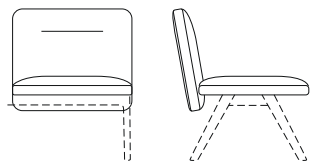

1 box
1 u. x box
0,139 M³



9,00
10,50

Armony Seat

Assise Armony
Sitz Armony

Cod. SED01

Injection moulded polyurethane foam seat padding with beech plywood and steel frame.
Rembourrage en polyuréthane expansée.
Polsterung aus geschäumtem Polyurethanschaum mit mehrschichtigem Buchenholz und Stahl.

UPHOLSTERY / REVETEMENT / BEZUG

B01/B03	C05	D02/D03	E01	P01
594 PTS	619 PTS	638 PTS	684 PTS	823 PTS

UPHOLSTERY ON REQUEST / REVETEMENT SUR REQUETE / ÜBERZUG AUF ANFRAGE

D04/D06	E02/E03/E04	I01/I02	M01/M02/M03
638 PTS	684 PTS	800 PTS	861 PTS

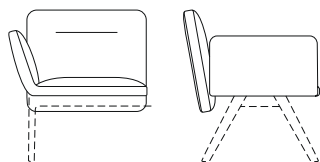

1 box
1 u. x box
0,139 M³



10,50
12,00

Armony seat with right armrest

Assise Armony avec accoudoir à droite
Sitz Armony mit rechter Armstütze

Cod. SED02

Injection moulded polyurethane foam seat padding with beech plywood and steel frame.
Rembourrage en polyuréthane expansée
Polsterung aus geschäumtem Polyurethanschaum mit mehrschichtigem Buchenholz und Stahl.

UPHOLSTERY / REVETEMENT / BEZUG

B01/B03	C05	D02/D03	E01	P01
876 PTS	911 PTS	938 PTS	1001 PTS	1196 PTS

UPHOLSTERY ON REQUEST / REVETEMENT SUR REQUETE / ÜBERZUG AUF ANFRAGE

D04/D06	E02/E03/E04	I01/I02	M01/M02/M03
938 PTS	1001 PTS	1165 PTS	1250 PTS

Additional modules Módulos adicionales Baumodule

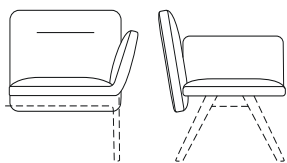

 1 box
 1 u. x box
 0,139 M³

 10,50
 12,00

Armony seat with left armrest Assise Armony avec accoudoir à gauche Sitz Armony mit linker Armstütze

Cod. SED03

Injection moulded polyurethane foam seat padding with beech plywood and steel frame.
 Rembourrage en polyuréthane expansée
 Polsterung aus geschäumtem Polyurethanschaum mit mehrschichtigem Buchenholz und Stahl.

UPHOLSTERY / REVETEMENT / BEZUG

B01/B03	C05	D02/D03	E01	P01
876 PTS	911 PTS	938 PTS	1001 PTS	1196 PTS

UPHOLSTERY ON REQUEST / REVETEMENT SUR REQUETE / ÜBERZUG AUF ANFRAGE

D04/D06	E02/E03/E04	I01/I02	M01/M02/M03
938 PTS	1001 PTS	1165 PTS	1250 PTS

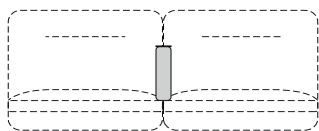

1 box
1 u. x box
0,012 M³



2,00
2,50

Central armrest
Accoudoir Armony
Armstütze Armony

Cod. BRF22

Slab polyurethane foam padding, steel frame.

Rembouillage en mousse de polyuréthane sectionnée, structure en acier

Polsterung aus Polyurethanschaum geschnitten, Gestell aus Stahl.

UPHOLSTERY / REVETEMENT / BEZUG

B01/B03	C05	D02/D03	E01	P01
207 PTS	214 PTS	220 PTS	234 PTS	277 PTS

UPHOLSTERY ON REQUEST / REVETEMENT SUR REQUETE / ÜBERZUG AUF ANFRAGE

D04/D06	E02/E03/E04	I01/I02	M01/M02/M03
220 PTS	234 PTS	269 PTS	288 PTS

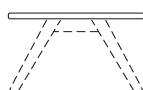
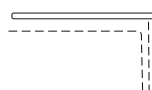

1 box
1 u. x box
0,017 M³



6,00
6,50

Side table
Petit table
Tisch

Cod. TAV20

MFC top with ABS plastic edge.

Plateau en mélamine avec chants en ABS

Platte aus Melamin mit ABS-Kante.

FINISH OPTIONS / FINITION / AUSFÜHRUNG

BA	CL	EC	OL	NO	RK
73 PTS	73 PTS	73 PTS	73 PTS	73 PTS	73 PTS

ON REQUEST ONLY / SUR REQUETE / AUF ANFRAGE



Matt lacquered top
Plateau laqué mat
Matt lackierte Platte

LA

+76 €

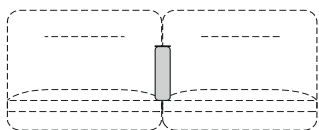

1 box
1 u. x box
0,014 M³



3,00
3,50

Central armrest with table
Accoudoir Armony avec table
Armstütze Armony mit Tisch

Cod. TAV21

Slab polyurethane foam padding, steel frame; Aluminium top powder coated in anthracite.

Rembouillage en mousse de polyuréthane sectionnée, structure en acier; tablette en aluminium verni gris ombre.

Polsterung aus Polyurethanschaum geschnitten, Gestell aus Stahl; Platte aus Aluminium dunkelgrau lackiert.

UPHOLSTERY / REVETEMENT / BEZUG

B01/B03	C05	D02/D03	E01	P01
320 PTS	328 PTS	334 PTS	348 PTS	390 PTS

UPHOLSTERY ON REQUEST / REVETEMENT SUR REQUETE / ÜBERZUG AUF ANFRAGE

D04/D06	E02/E03/E04	I01/I02	M01/M02/M03
334 PTS	348 PTS	383 PTS	402 PTS

Agio break-out lounge swivel armchair

Chaufeuse Agio

Loungesessel Agio

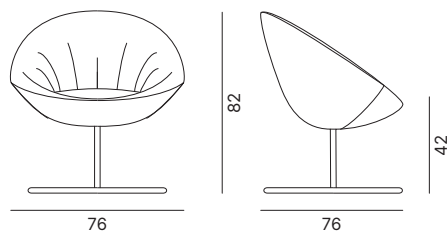

Cod. OAGIOV01

Steel inner shell; injection molded polyurethane foam; swivel chair, no gaslift.

Structure en acier; rembourrage en polyuréthane expansée mousse à froid; vérin pivotant sans lift.

Stahlstabgestell; kaltgeschäumte Polyurethan-Polsterung; Drehlift ohne Höhenverstellung.



Upholstery in fire retardant foam



1 box
1 u. x box
0,490 M³



11,50
14,50



UPHOLSTERY / REVETEMENT / BEZUG

B01/B03	C01/C05	D02/D03	E01	P01
744 PTS	794 PTS	815 PTS	887 PTS	1003 PTS

UPHOLSTERY ON REQUEST / REVETEMENT SUR REQUETE / ÜBERZUG AUF ANFRAGE

D04	E02/E03/E04	I01/I02	M01/M02/M03
815 PTS	887 PTS	1076 PTS	1172 PTS

BASE / BASE / GESTELL

	Polished aluminium 4-star base Piètement 4 branches en aluminium brillant 4-Sternfußkreuz Alu poliert	BAA04	=
	Chrome weighted flat base Piètement plat "design" chromé Tellerfuß, Aluminium poliert	BAC02	+273 PTS

ACCESSORIES / ACCESSOIRES / ZUBEHÖR

	Auto return mechanism, brings the seat back to its original position when no longer in use, with BAA04 base only Vérin avec système de retour automatique à point fixe, possible que avec BAA04 Automatische Sitzrückstellung, nur in Kombination mit BAA04	ALZ01	+87 PTS
---	--	--------------	---------

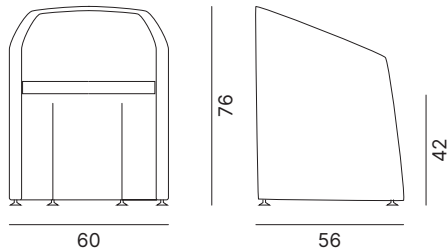

Cod. OALIAV01

Steel structural inner frame; seat inner frame made from beech plywood; injection molded polyurethane foam.

Structure portante en acier à plusieurs sections; intérieure assise en multi-plis de hêtre; rembourrage en polyuréthane expansée mousse à froid.

Tragendes Stahlgestell; Sitzinnenseite aus mehrschichtigem Buchenholz; Polsterung aus kaltgeschäumtem Polyurethan.



Upholstery in fire retardant foam



1 box
 1 u. x box
 0,340 M³



10,00
 13,00

UPHOLSTERY / REVETEMENT / BEZUG

B01/B03	C01/C05	D02/D03	E01	P01
597 PTS	652 PTS	682 PTS	784 PTS	930 PTS

UPHOLSTERY ON REQUEST / REVETEMENT SUR REQUETE / ÜBERZUG AUF ANFRAGE

D04/D06	E02/E03
682 PTS	784 PTS

Alias swivel armchair Chaufeuse pivotante Alias Loungesessel Alias, drehbar

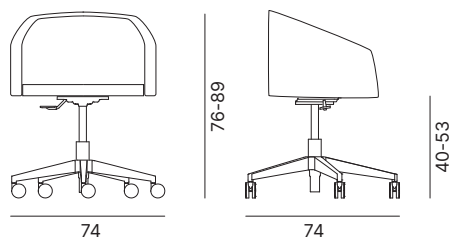

Cod. OALIAA01

Steel structural inner frame; seat inner frame made from beech plywood; injection molded polyurethane foam; steel plate; swivel chair; gas lift available except with the BAA04 4-star base on glides.

Structure portante en acier à plusieurs sections; intérieure assise en multi-plis de hêtre; rembourrage en polyuréthane expansée mousse à froid; plaque en acier; vérin à gaz lift; avec BAA04 (visiteur) le vérin pivotant est sans lift.

Tragkonstruktion aus Stahl mit verschiedenen Profilen; Sitzinnenseite aus Buchensperrholz; Polsterung aus kaltgeschäumtem Polyurethanschaum; Stahlplatte; Gasfeder; bei BAA04 (Besuchersessel) ist der Drehlift ohne Höhenverstellung.



Upholstery in fire retardant foam

1 box
1 u. x box
0,220 M³

10,00
13,00



UPHOLSTERY / REVETEMENT / BEZUG

B01/B03	C01/C05	D02/D03	E01	P01
471 PTS	505 PTS	520 PTS	588 PTS	691 PTS

UPHOLSTERY ON REQUEST / REVETEMENT SUR REQUETE / ÜBERZUG AUF ANFRAGE

D04/D06	E02/E03
520 PTS	588 PTS

BASE / BASE / GESTELL

	Black nylon 5-star base Piètement 5 branches en nylon noir 5-Sternfußkreuz aus schwarzem Nylon	BAN01	=
	Polished aluminium 5-star base Piètement 5 branches en aluminium brillant 5-Sternfußkreuz aus poliertem Aluguss	BAA01	+49 PTS
	Polished aluminium 4-star base Piètement 4 branches en aluminium brillant 4-Sternfußkreuz Alu poliert	BAA04	+49 PTS



Index

Accessories &	230	MONTREAL
Side Tables	231	MIAMI
	234	MELBOURNE
	237	COZY
	238	T01
	238	T02
	238	T03
	238	T05
	238	T06
	239	FLIPPER
	243	PETAL & CLOAK
	246	ALTER EGO

COFFEE TABLES

designed by Quadrifoglio Group



MFC TOP / PLATEAU EN MÉLAMINE / MELAMINPLATTEN

18mm easy to clean scratch-resistant anti-reflective melamine faced chipboard (MFC) top finished with 1mm straight ABS impact resistant edging. Finish options: melamine as well as matt lacquered. MFC panel density: 670/730 kgs per cubic meter.











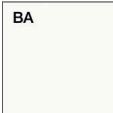

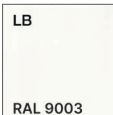



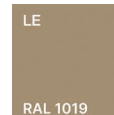
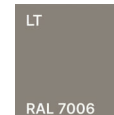
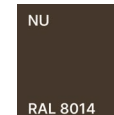

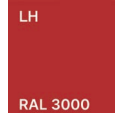
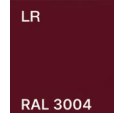

Plateaux réalisés en aggloméré ép. 18 mm, revêtus dans les deux côtés avec papier mélamine anti-reflet, anti-rayures et lavable. Chant périmétrale antichoc en ABS ép. 1 mm. Disponibles dans les finitions mélaminés ou en mélamine laqué mat. Densité panneau: 670/730 kg/m3.

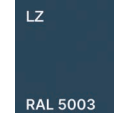
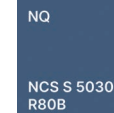
Platten aus Holzkonglomerat 18mm stark, beidseitig mit reflexfreiem, kratzfestem und waschbarem Melaminpapier beschichtet. Mit 4-seitige stoßfester ABS-Kante, St. 1mm. Lieferbar in den Melaminausführungen oder in den matt lackierten Melaminausführungen. Dichte der Platte: 670/730 kg/m3.

Finishes

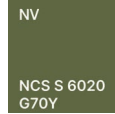
Finitions

Ausführungen

 BA	 CL	 TA						
White Blanc Weiss	Concrete Béton Beton	Anthracite linen Tissu gris Leinen grau						
 LB	 LL	 LS	 NK	 LE	 LT	 NU	 NJ	
RAL 9003 White Blanc Weiss	RAL 9002 Grey White Blanc Gris Grauweiss	RAL 7044 Silk Grey Gris Soie Seidengrau	NCS S 2010 Y30R Light Beige Beige clair Beige Hell	RAL 1019 Beige Beige Beige	RAL 7006 Beige Grey Gris Beige Beige-grau	RAL 8014 Dark Brown Marron foncé Dunkelbraun	NCS S 4040 Y50R Burnt Orange Orange brûlé Verbrannte Orange	
 NW	 LA	 LH	 LR	 LI	 LZ	 NQ	 LC	
RAL 1006 Ocher Jaune moutard Ockergelb	RAL 2000 Orange Orange Orange	RAL 3000 Flame Red Rouge Feu Feuerrot	RAL 3004 Purple Red Rouge Pourpre Purpurrot	RAL 3007 Black Red Rouge foncé Schwarz Rot	RAL 5003 Sapphire Blue Bleu Saphire Saphirblau	NCS S 5030 R80B Cobalt Blue Bleu Cobalt Kobaltblau	RAL 5014 Pigeon Blue Bleu Pigeon Tauben Blau	
 LD	 LP	 NV	 LF	 LG	 LO	 LN		
RAL 5020 Ocean Blue Bleu Océan Ozeanblau	RAL 6028 Pine Green Vert pin Kieferngrün	NCS S 6020 G70Y Olive Green Vert olive Olivgrün	RAL 7047 Telegrey 4 Telegris 4 Telegrau 4	RAL 7004 Grey Gris Grau	RAL 7022 Umbra Grey Gris Ombre Umbragrau	RAL 9017 Traffic Black Noir Signalisation Verkehrsschwarz		

Production lead time: 5 weeks exclusive of delivery time. Apart from the shown finish options any RAL color can be made to order.

Délai de fabrication: 5 semaines; tous les finitions RAL sont disponibles sur requête

Lieferzeit: 5 Wochen; zusätzlich zu den vorgeschlagenen Lackierungen sind alle Ausführungen der RAL-Skala verfügbar

Depending on the surface the color may vary slightly from the reference (RAL / NCS) provided.

En fonction de la surface, la couleur peut varier légèrement par rapport à la référence (RAL / NCS) fournie.

Je nach Oberfläche kann die Farbe in Bezug auf die RAL/NCS Referenz abweichen.

PORCELAIN TOPS / PLATEAUX EN GRÈS DE PORCELAINE / PLATTEN AUS FEINSTEINZEUG

18mm matt umbra grey painted MDF base with 13mm 45° beveled edges bonded to a 5mm PORCELAIN top with 1.5mm 45° beveled flat edges; the top is either 5mm or 3mm thick depending on the finish.





Réalisés par encollage dans le couplage d'un plateau inférieur en MDF ép. 18 mm avec chant périmétrale arrondi 13 x 45° et verni couleur gris ombre mat, avec une plaque supérieure en GRES ép. 3 ou 5 mm selon la finition, avec chants à fil plat et arrondis 1,5 mm x 45°.

Hergestellt durch Aufkleben einer 18 mm dicken, dunkelgrau matt lackierten MDF-Unterplatte mit 13 x 45° abgeschrägten Kanten mit einer je nach Ausführung 3 oder 5 mm dicken Deckplatte aus Feinsteinzeug mit flachen, bündigen Kanten und 1,5 mm x 45° abgeschrägten Kanten.

Finishes

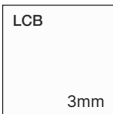
Finitions

Ausführungen

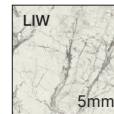
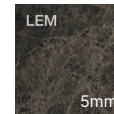
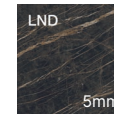
 LCB	 LFT	 LFP	 LNG	 LIW	 LEM	 LND
3mm	3mm	3mm	3mm	5mm	5mm	5mm
Collection Bianco	Fokos Terra	Fokos Piombo	Nero Greco	Invisible White	Emperador Lucido	Noir Desir Lucido

Specification sheet Caractéristiques techniques Technische Beschreibungen

DECORATIVE METAL EDGES (OPTIONAL EXTRA) / CHANTS DECORATIFS EN MÉTAL (EN OPTION) / DEKOR METALLKANTEN (OPTIONAL)

40mm high 2mm steel edges powder coated in matt colours or liquid coated featuring a metallic effect.

Chants périmétrales décoratifs à appliquer aux plateaux, réalisés en tôle d'acier ép. 2 mm, H. 40 mm, avec supports pour la fixation soudée. Vernis à poudre époxy dans les couleurs mats ou à liquide avec effets métalliques.

Dekor Kanten zur Befestigung an den Platten, hergestellt aus Stahlblech St.2mm, H.40mm, mit aufgeschweißten Halterungen. Epoxidpulverbeschichtet in Mattfarben oder flüssig beschichtet mit Metalleffekten.

Finishes Finitions Ausführungen

O	R	OR*	BR*	CO*
RAL 9010	RAL 7022			
Matt white Blanc mat Weiss matt	Umbr Grey Gris ombre Dunkelgrau	Gold Or Gold	Bronze Bronze Bronze	Corten Corten Korten

* Production lead time: 5 weeks exclusive of delivery time
Délai de fabrication: 5 semaines
Lieferzeit: 5 Wochen

Depending on the surface the color may vary slightly from the reference (RAL / NCS) provided.
En fonction de la surface, la couleur peut varier légèrement par rapport à la référence (RAL / NCS) fournie.
Je nach Oberfläche kann die Farbe in Bezug auf die RAL/NCS Referenz abweichen.

PLANTERS / CONTENEURS PORTE-VASES / PFLANZKASTEN

1.5mm steel circular decorative pot powder coated in matt colours or liquid coated featuring a metallic effect. The metal frame is fitted to the bottom of the decorative pot. We recommend setting plants in grow pots and saucers to avoid contact with soil and water. Internal size of small decorative pot ø360mm x 140mm high. Internal size of large decorative pot ø460mm x 180mm high.

Conteneurs cylindriques réalisés en tôle d'acier ép. 1,5 mm avec fond soudé équipé de pivots pour la fixation des structures en métal. Vernis à poudre époxy dans couleurs mats ou à liquide avec effets métalliques. Conseillé l'intégration des plats avec le vase approprié pour contenir la terre et l'eau.

Zylindrische Behälter aus Stahlblech St.1,5mm mit geschweißtem Boden, ausgestattet mit Bolzen zur Befestigung von Metallgestellen. Epoxidpulverbeschichtet in Mattfarben oder flüssig beschichtet mit Metalleffekten. Es ist stark empfohlen, dass die Pflanzen mit ihren eigenen Behältern für Wasser und Erde in die Pflanzkasten montiert werden.

Finishes Finitions Ausführungen

O	R	OR*	BR*	CO*
RAL 9010	RAL 7022			
Matt white Blanc mat Weiss matt	Umbr Grey Gris ombre Dunkelgrau	Gold Or Gold	Bronze Bronze Bronze	Corten Corten Korten

* Production lead time: 5 weeks exclusive of delivery time
Délai de fabrication: 5 semaines
Lieferzeit: 5 Wochen

Depending on the surface the color may vary slightly from the reference (RAL / NCS) provided.
En fonction de la surface, la couleur peut varier légèrement par rapport à la référence (RAL / NCS) fournie.
Je nach Oberfläche kann die Farbe in Bezug auf die RAL/NCS Referenz abweichen.

POUFFS / POUF / POUF

Structural seat inner frame made of solid birch wood, fire resistant rubber and polyster resin padding upholstered in a variety of fabrics and leathers

Coussins avec coque en multi-plis de bois de bouleau rembourrage en mousse et résiné de polyester non-feu avec revêtement externe en différentes tissus.

Kissen mit Schale aus Birkensperholz, Gummipolsterung und feuerfester Polyesterharze mit Außenbezug aus verschiedenen Stoffen.

Finishes Finitions Ausführungen

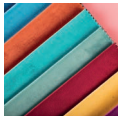

B01-B03-C01-C05-D02-D03-D04-D05-D06-P01-
E01-E02 -E03-E04-I01-I02-M01-M02-M03

METAL FRAME / STRUCTURE METALLIQUE / METALLGESTELL

MIAMI - 10×10mm steel frame powder coated in matt colours or liquid coated featuring a metallic effect. Welded steel brackets provide fixing points for the upper element - top, seat or pot. Four anti-slip rubber glides.

MONTREAL - 10×10mm steel frame powder coated in matt colours or liquid coated featuring a metallic effect. Welded steel brackets provide fixing points for the upper element - top, seat or pot. Four anti-slip rubber glides.

MIAMI - Structure réalisée en tréfilé d'acier section 10×10 mm, vernie à poudre époxy dans les couleurs mats ou à liquide avec effets métalliques. Supports en tôle d'acier soudés dans la partie supérieure pour la fixation des plateaux, des coussins pouf et des conteneurs porte-vases. N.4 embouts en caoutchouc anti-glissement appliqués dans la partie inférieure.

MONTREAL - Structure réalisée en tréfilé d'acier section 10×10 mm, vernie à poudre époxy dans les couleurs mats ou à liquide avec effets métalliques. Supports en tôle d'acier soudés dans la partie supérieure pour la fixation des plateaux. N.4 embouts en caoutchouc anti-glissement appliqués dans la partie inférieure.

MIAMI - Rahmen aus gezogenem Stahl mit Querschnitt 10×10mm, epoxidpulverbeschichtet in Mattfarben oder flüssig beschichtet mit Metalleffekten. Halterungen aus Stahlblech, oben aufgeschweißt, zur Befestigung der Platten, der Kissen und der Pflanzkasten. Im unteren Teil gibt es 4 rutschfeste Gummipads.

MONTREAL - Rahmen aus gezogenem Stahl mit Querschnitt 10×10mm, epoxidpulverbeschichtet in Mattfarben oder flüssig beschichtet mit Metalleffekten. Halterungen aus Stahlblech, oben aufgeschweißt, zur Befestigung der Platten. Im unteren Teil gibt es 4 rutschfeste Gummipads.

Finishes

Finitions
Ausführungen

O RAL 9010	R RAL 7022	OR*	BR*	CO*
Matt white Blanc mat Weiss matt	Umбра Grey Gris ombre Dunkelgrau	Gold Or Gold	Bronze Bronze Bronze	Corten Corten Korten

* Production lead time: 5 weeks exclusive of delivery time
Délai de fabrication: 5 semaines
Lieferzeit: 5 Wochen

Depending on the surface the color may vary slightly from the reference (RAL / NCS) provided.
En fonction de la surface, la couleur peut varier légèrement par rapport à la référence (RAL / NCS) fournie.
Je nach Oberfläche kann die Farbe in Bezug auf die RAL/NCS Referenz abweichen.

WOODEN FRAME / PIEDS EN BOIS / HOLZFÜSSE

ø40mm tapered cone solid ash legs stained in a variety of finishes, supplied with threaded bushes as fixing points for the upper element - top, seat or pot. Nylon glides with anti-slip felt pads.

Pieds coniques, diam. 40 mm, réalisés en bois de frêne séché et verni en plusieurs finitions, avec prédisposition dans la partie supérieure d'insert filé pour la fixation des plateaux, des coussins pouf et des conteneurs porte-vases. Patins en nylon dans la partie inférieure, feutrés anti-glissement.

Konische Füße, D.40mm, hergestellt aus gedörtem Eschenholz, in verschiedenen Ausführungen lackiert. Gewindehülse auf dem Oberteil zur Befestigung der Platten, der Kissen Pouf und der Pflanzkasten. Nylonfüße im unteren Teil, mit Filzgleitern.

Finishes

Finitions
Ausführungen

FK	FN	FO	FG
Oak Chêne Eiche hell	Canaletto Walnut Noyer Canaletto Nuss Canaletto	Elm Orme Ulme	Umбра Grey Gris ombre Dunkelgrau

Specification sheet
Caractéristiques techniques
Technische Beschreibungen

MFC TOP / PLATEAU EN MÉLAMINE / MELAMINPLATTEN

18mm easy to clean scratch-resistant anti-reflective melamine faced chipboard (MFC) top finished with 1mm straight ABS impact resistant edging. Finish options: melamine as well as matt lacquered. MFC panel density: 670/730 kgs per cubic meter.

Plateaux réalisés en aggloméré ép. 18 mm, revêtus dans les deux côtés avec papier mélamine anti-reflet, anti-rayures et lavable. Chant périmétrale antichoc en ABS ép. 1 mm. Disponibles dans les finitions mélaminés ou en mélamine laqué mat. Densité panneau: 670/730 kg/m³.

Platten aus Holzkonglomerat 18mm stark, beidseitig mit reflexfreiem, kratzfestem und waschbarem Melaminpapier beschichtet. Mit 4-seitige stoßfester ABS-Kante, St. 1mm. Lieferbar in den Melaminausführungen oder in den matt lackierten Melaminausführungen. Dichte der Platte: 670/730 kg/m³.

Finishes

Finitions
 Ausführungen

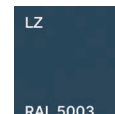
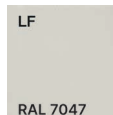
BA 	RK 	NO 							
White Blanc Weiss	Oak Chêne Eiche hell	Canaletto Walnut Noyer Canaletto Nuss Canaletto							
LB 	LL 	LS 	NK 	LE 	LT 	NU 	NJ 		
White Blanc Weiss	Grey White Blanc Gris Grauweiss	Silk Grey Gris Soie Seidengrau	Light Beige Beige clair Beige Hell	Beige Beige Beige	Beige Grey Gris Beige Beige-grau	Dark Brown Marron foncé Dunkelbraun	Burnt Orange Orange brûlé Verbrannte Orange		
NW 	LA 	LH 	LR 	LI 	LZ 	NQ 	LC 		
Ocher Jaune moutard Ockergelb	Orange Orange Orange	Flame Red Rouge Feu Feuerrot	Purple Red Rouge Pourpre Purpurrot	Black Red Rouge foncé Schwarz Rot	Sapphire Blue Bleu Saphire Saphirblau	Cobalt Blue Bleu Cobalt Kobaltblau	Pigeon Blue Bleu Pigeon Tauben Blau		
LD 	LP 	NV 	LF 	LG 	LO 	LN 			
Ocean Blue Bleu Océan Ozeanblau	Pine Green Vert pin Kieferngrün	Olive Green Vert olive Olivgrün	Telegrey 4 Telegris 4 Telegrau 4	Grey Gris Grau	Umbra Grey Gris Ombre Umbragrau	Traffic Black Noir Signalisation Verkehrsschwarz			

Production lead time: 5 weeks exclusive of delivery time. Apart from the shown finish options any RAL color can be made to order.

Délai de fabrication: 5 semaines; tous les finitions RAL sont disponibles sur requête

Lieferzeit: 5 Wochen; zusätzlich zu den vorgeschlagenen Lackierungen sind alle Ausführungen der RAL-Skala verfügbar

Depending on the surface the color may vary slightly from the reference (RAL / NCS) provided.

En fonction de la surface, la couleur peut varier légèrement par rapport à la référence (RAL / NCS) fournie.

Je nach Oberfläche kann die Farbe in Bezug auf die RAL/NCS Referenz abweichen.

HPL TOP / PLATEAUX EN HPL / HPL-PLATTEN

Tops in 10mm decorative High Pressure Laminate (HPL), black edging, manufactured from cellulose fiber (60-70%) impregnated by thermoset resins (30-40%) and pressed at high temperature. HPL is a wear resistant material ideal for steam and thermal shocks; easy to maintain and highly hygienic.

Plateau en stratifié décoratif à haute pression (HPL) ép. 10 mm avec chant noir, réalisé entièrement en fibre de cellulose (60-70%) imprégné de résine thermodurcissables (30-40%) et pressé à haute températures. L'HPL est très résistant à l'usage, au vapeur et aux chocs thermiques; c'est facile à manutentionner et à haut niveau hygiénique.

Dekorative Hochdrucklaminatplatten (HPL), 10 mm stark mit schwarzer Kante, vollständig aus Zellulosefasern (60-70%) hergestellt, die mit wärmehärtenden Harzen (30-40%) imprägniert sind und bei hohen Temperaturen gepresst werden. HPL ist sehr widerstandsfähig gegen Abnutzung, Dampf und Temperaturschwankungen, leicht zu pflegen und sehr hygienisch.

Finishes

Finitions
 Ausführungen

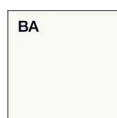

White
Blanc
Weiss

METAL FRAME / STRUCTURE METALLIQUE / METALLGESTELL

Ø20mm steel frame powder coated in matt colours or liquid coated featuring a metallic effect. Articulating feet with felt pads.

Structure en tube d'acier Ø22mm, vernie à poudre époxy dans les couleurs mats ou à liquide avec effets métalliques.
Avec patins feutrés anti-glisserment.

Gestell aus Stahlrohr Ø20mm, epoxidpulverbeschichtet in Mattfarben oder flüssig beschichtet mit Metalleffekten. Gelenkfüße mit Filz.

Finishes

Finitions

Ausführungen

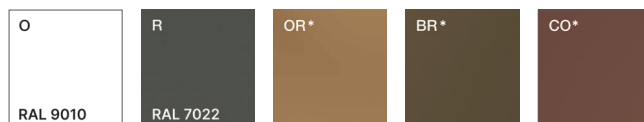

Matt white	Umбра Grey	Gold	Bronze	Corten
Blanc mat	Gris ombre	Or	Bronze	Corten
Weiss matt	Dunkelgrau	Gold	Bronze	Korten

* Production lead time: 5 weeks exclusive of delivery time
Délai de fabrication: 5 semaines
Lieferzeit: 5 Wochen

Depending on the surface the color may vary slightly from the reference (RAL / NCS) provided.
En fonction de la surface, la couleur peut varier légèrement par rapport à la référence (RAL / NCS) fournie.
Je nach Oberfläche kann die Farbe in Bezug auf die RAL/NCS Referenz abweichen.

WOODEN FRAME / PIEDS EN BOIS / HOLZFÜSSE

Solid ash legs stained in a variety of finishes. Nylon glides with anti-slip felt pads.

Pieds réalisés en bois de frêne séché et verni en plusieurs finitions. Patins en nylon dans la partie inférieure, feutrés anti-glisserment.

Füße hergestellt aus gedörrtem Eschenholz, in verschiedenen Ausführungen lackiert. Nylonfüße im unteren Teil, mit Filzgleitern.

Finishes

Finitions

Ausführungen



Oak	Canaletto Walnut	Umбра Grey
Chêne	Noyer Canaletto	Gris ombre
Eiche hell	Nuss Canaletto	Dunkelgrau

Specification sheet Caractéristiques techniques Technische Beschreibungen

MFC TOP / PLATEAU EN MÉLAMINE / MELAMINPLATTEN





30mm easy to clean scratch-resistant anti-reflective melamine faced chipboard (MFC) circular (T01, T03) or square (T02) top finished with 2mm matching straight ABS impact resistant edges. Finish options: melamine as well as matt lacquered. MFC panel density: 670/730 kgs per cubic meter.

Plateau rond (T01, T03) ou carré (T02) en aggloméré ép. 30 mm, revêtu sur deux côtés avec papier de mélamine anti-rayures et antireflet; chants droits en ABS ép. 2 mm antichoc sur les 4 cotés assortis au plan. Disponibles dans les finitions mélaminés ou en mélamine laqué mat.
Densité panneau: 670/730 kg/m³

Runde (T01, T03) oder quadratische (T02) Platte aus 30 mm starkem Holzkonglomerat, beidseitig mit entspiegeltem, kratzfestem und waschbarem Melaminpapier belegt. Kantenverkleidung am Umfang aus schlagfestem ABS, in der gleichen Farbe, Stärke 2 mm. Lieferbar in den Melaminausführungen oder in den matt lackierten Melaminausführungen. Dichte der Platte: 670/730 kg/m³

Finishes

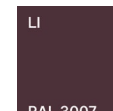
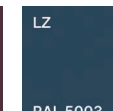
Finitions
Ausführungen

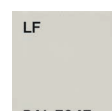
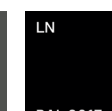
 RAL 9003	 RAL 9002	 RAL 7044	 NCS S 2010 Y30R	 RAL 1019	 RAL 7006	 RAL 8014	 NCS S 4040 Y50R
White Blanc Weiss	Grey Gris Gru	Whitened Elm Orme Blanchi Ulme Weiß	Beech Hêtre Buche	Oak Chêne Eiche hell	Elm Orme Ulme	Eucalyptus Eucalyptus Eukalyptus	Canaletto Walnut Noyer Canaletto Nuss Canaletto
 RAL 9003	 RAL 9002	 RAL 7044	 NCS S 2010 Y30R	 RAL 1019	 RAL 7006	 RAL 8014	 NCS S 4040 Y50R
White Blanc Weiss	Grey White Blanc Gris Grauweiss	Silk Grey Gris Soie Seidengrau	Light Beige Beige clair Beige Hell	Beige Beige Beige	Beige Grey Gris Beige Beigegrau	Dark Brown Marron foncé Dunkelbraun	Burnt Orange Orange brûlé Verbrannte Orange
 RAL 1006	 RAL 2000	 RAL 3000	 RAL 3004	 RAL 3007	 RAL 5003	 NCS S 5030 R80B	 RAL 5014
Ochre Jaune moutard Ockergelb	Orange Orange Orange	Flame Red Rouge Feu Feuerrot	Purple Red Rouge Pourpre Purpurrot	Black Red Rouge foncé Schwarz Rot	Sapphire Blue Bleu Saphire Saphirblau	Cobalt Blue Bleu Cobalt Kobaltblau	Pigeon Blue Bleu Pigeon Tauben Blau
 RAL 5020	 RAL 6028	 NCS S 6020 G70Y	 RAL 7047	 RAL 7004	 RAL 7022	 RAL 9017	
Ocean Blue Bleu Océan Ozeanblau	Pine Green Vert pin Kieferngrün	Olive Green Vert olive Olivgrün	Telegrey 4 Telegris 4 Telegrau 4	Grey Gris Gru	Umbra Grey Gris Ombre Umbragru	Traffic Black Noir Signalisation Verkehrsschwarz	

Production lead time: 5 weeks exclusive of delivery time. Apart from the shown finish options any RAL color can be made to order.

Délai de fabrication: 5 semaines; tous les finitions RAL sont disponibles sur requête

Lieferzeit: 5 Wochen; zusätzlich zu den vorgeschlagenen Lackierungen sind alle Ausführungen der RAL-Skala verfügbar

METAL FRAMES / STRUCTURE MÉTALLIQUE / METALLGESTELLE

T01 - epoxy powder coated steel column base made of a 1.5mm thick ø80mm column and a 6mm Ø500mm base. Translucid seal along the perimeter of the base to prevent marking.

T02 - epoxy powder coated steel column base made of a 1.5mm thick 60×60mm square column and a 6mm thick 480×480mm square pyramid shaped base. Translucid seal along the perimeter of the base to prevent marking.

T03 - single-piece cone-shaped 1mm thick epoxy powder coated steel weighted base. Includes adhesive felt pads to prevent marking.

T01 - Piètement en tube d'acier Ø80 mm ép. 1,5 mm avec base Ø500 mm ép. 6 mm, vernis à poudre époxy. Joint transparent tout autour de la base.

T02 - Piètement en tube d'acier à section carré 60×60 mm, ép. 1,5 mm avec base en tôle pressée à forme pyramidal 480×480 mm, ép. 6 mm, vernis à poudre époxy. Joint transparent tout autour de la base.

T03 - Piètement en acier ép. 1 mm, verni à poudre époxy, avec ballast métallique et patins adhésives.



T01 - Gestell bestehend aus einem Stahlrohr Ø80 mm Stärke 1,5 mm und einem Bodenständer Ø500 mm Stärke 6 mm, lackiert mit Epoxidpulvern. Transparente Dichtung entlang der Unterkante der Bodenplatte.

T02 - Gestell bestehend aus einem quadratischen Querschnitt 60×60 mm Stahlrohrschenkel, 1,5 mm stark, und einem 6 mm starken pyramidenförmigen Blechpreßstift 480×480 mm, lackiert mit Epoxidpulvern. Transparente Dichtung entlang der Unterkante der Bodenplatte.

T03 - Gestell aus 1 mm starkem Stahl, epoxidpulverbeschichtet, mit Metallballast und Klebepads.

Finishes

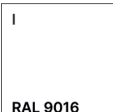
Finitions
Ausführungen

 RAL 9016	 RAL 9006	 RAL 7022
White Blanc Weiss	Silver Aluminium Alu	Shadow grey Gris ombre Dunkelgrau

Depending on the surface the color may vary slightly from the reference (RAL / NCS) provided.

En fonction de la surface, la couleur peut varier légèrement par rapport à la référence (RAL / NCS) fournie.

Je nach Oberfläche kann die Farbe in Bezug auf die RAL/NCS Referenz abweichen.

MFC TOP / PLATEAU EN MÉLAMINE / MELAMINPLATTEN

30mm easy to clean scratch-resistant anti-reflective melamine faced chipboard (MFC) top and perimeter panels finished with 2mm matching straight ABS impact resistant edges. 45° mitred top and panels. Available in melamine or lacquered. Panel density: 670/730 kgs per cubic meter.

Plateau et bandes en aggloméré ép. 30 mm, revêtu sur deux cotés avec papier de mélamine anti-rayures et antireflet; chants droits en ABS ép. 2 mm antichoc sur les 4 cotés assortis au plan et coupés à 45°. Disponible dans les finitions en mélamine ou mélamine laqué. Densité panneau: 670/730 kg/m³.

Tischplatten und Umrandungsplatten aus 30 mm starkem Holzkonglomerat, beidseitig mit reflexfreiem, kratzfestem und waschbarem Melaminpapier belegt. 4-seitige Kante aus schlagfestem ABS, in der gleichen Farbe, 2 mm stark und 45° verbunden. In Melamin bzw. Melamin lackiert verfügbar. Dichte der Platte: 670/730 kg/m³.

Finishes
Finitions
Ausführungen

								
White Blanc Weiss	Grey Gris Grau	Whitened Elm Orme Blanchi Ulme Weiß	Oak Chêne Eiche hell	Elm Orme Ulme	Eucalyptus Eucalyptus Eukalyptus	Canaletto Walnut Noyer Canaletto Nuss Canaletto		
								
White Blanc Weiss	Grey White Blanc Gris Grauweiss	Silk Grey Gris Soie Seidengrau	Light Beige Beige clair Beige Hell	Beige Beige Beige	Beige Grey Gris Beige Beigegrau	Dark Brown Marron foncé Dunkelbraun	Burnt Orange Orange brûlé Verbrannte Orange	
								
Ocher Jaune moutard Ockergelb	Orange Orange Orange	Flame Red Rouge Feu Feuerrot	Purple Red Rouge Pourpre Purpurrot	Black Red Rouge foncé Schwarz Rot	Sapphire Blue Bleu Saphire Saphirblau	Cobalt Blue Bleu Cobalt Kobaltblau	Pigeon Blue Bleu Pigeon Tauben Blau	
								
Ocean Blue Bleu Océan Ozeanblau	Pine Green Vert pin Kieferngrün	Olive Green Vert olive Olivgrün	Telegrey 4 Telegris 4 Telegrau 4	Grey Gris Grau	Umbra Grey Gris Ombre Umbragrau	Traffic Black Noir Signalisation Verkehrsschwarz		

Production lead time: 5 weeks exclusive of delivery time. Apart from the shown finish options any RAL color can be made to order.
Délai de fabrication: 5 semaines; tous les finitions RAL sont disponibles sur requête
Lieferzeit: 5 Wochen; zusätzlich zu den vorgeschlagenen Lackierungen sind alle Ausführungen der RAL-Skala verfügbar

Depending on the surface the color may vary slightly from the reference (RAL / NCS) provided.
En fonction de la surface, la couleur peut varier légèrement par rapport à la référence (RAL / NCS) fournie.
Je nach Oberfläche kann die Farbe in Bezug auf die RAL/NCS Referenz abweichen.

BASE / STRUCTURE EN MÉLAMINE / GESTELL AUS MELAMIN

Top and perimeter panels are supported on a 18mm easy to clean scratch-resistant anti-reflective melamine faced chipboard (MFC) base finished with 1.5mm matching straight ABS impact resistant edges. Supplied with ø20mm polyethylene 0-8mm adjustable levelling feet.

Structure interne en aggloméré ép.18 mm, revêtu sur deux cotés avec papier de mélamine anti-rayures et antireflet; chants droits en ABS ép. 2 mm antichoc sur les 4 cotés assortis au plan. Avec vérin de réglage en PE, diamètre 20 mm, réglage 0-8 mm.

Innenstruktur aus 18 mm starker Holzkonglomeratplatte, beidseitig mit reflexfreiem, kratzfestem und waschbarem Melaminpapier belegt. Stoßfeste ABS-Kante, in der gleichen Farbe, 1,5 mm stark. Mit PE-Nivellierfüßen, Durchmesser 20 mm, Verstellung von 0 bis 8 mm.

Melamine
Mélamine
Melamin

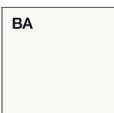
						
White Blanc Weiss	Grey Gris Grau	Whitened Elm Orme Blanchi Ulme Weiß	Oak Chêne Eiche hell	Elm Orme Ulme	Eucalyptus Eucalyptus Eukalyptus	Canaletto Walnut Noyer Canaletto Nuss Canaletto

Specification sheet

Caractéristiques techniques

Technische Beschreibungen

MFC TOPS / PLATEAUX EN MÉLAMINE / MELAMINPLATTEN



30mm easy to clean scratch-resistant anti-reflective melamine faced chipboard (MFC) top finished with 2mm matching straight ABS impact resistant edges. Panel density: 670/730 kgs per cubic meter.

Plateaux en aggloméré ép. 30 mm, revêtu sur deux cotés avec papier de mélamine anti-rayures et antireflet; chants droits en ABS ép. 2 mm antichoc sur les 4 cotés assortis au plan. Densité panneau: 670/730 kg/m³

Platten aus 30 mm starkem Holzkonglomerat, beidseitig mit reflexfreiem, kratzfestem und waschbarem Melaminpapier überzogen. 2 mm starke, stoßfeste ABS-Kante in gleicher Farbe. Dichte der Platte: 670/730 kg/m³

Finishes

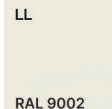
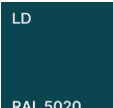
Finitions
Ausführungen

BA 	GR 	OB 	RK 	OL 	EC 	NO 													
White Blanc Weiss	Grey Gris Grau	Whitened Elm Orme Blanchi Ulme Weiß	Oak Chêne Eiche hell	Elm Orme Ulme	Eucalyptus Eucalyptus Eukalyptus	Canaletto Walnut Noyer Canaletto Nuss Canaletto													
LB 	LL 	LS 	NK 	LE 	LT 	NU 	NJ 												
White Blanc Weiss	Grey White Blanc Gris Grauweiss	Silk Grey Gris Soie Seidengrau	Light Beige Beige clair Beige Hell	Beige Beige Beige	Beige Grey Gris Beige Beigegrau	Dark Brown Marron foncé Dunkelbraun	Burnt Orange Orange brûlé Verbrannte Orange												
NW 	LA 	LH 	LR 	LI 	LZ 	NQ 	LC 												
Ocher Jaune moutard Ocker gelb	Orange Orange Orange	Flame Red Rouge Feu Feuerrot	Purple Red Rouge Pourpre Purpurrot	Black Red Rouge foncé Schwarz Rot	Sapphire Blue Bleu Saphire Saphirblau	Cobalt Blue Bleu Cobalt Kobaltblau	Pigeon Blue Bleu Pigeon Tauben Blau												
LD 	LP 	NV 	LF 	LG 	LO 	LN 													
Ocean Blue Bleu Océan Ozeanblau	Pine Green Vert pin Kieferngrün	Olive Green Vert olive Olivgrün	Telegrey 4 Telegris 4 Telegrau 4	Grey Gris Grau	Umbr Grey Gris Ombre Umbragrau	Traffic Black Noir Signalisation Verkehrsschwarz													

Production lead time: 5 weeks exclusive of delivery time. Apart from the shown finish options any RAL color can be made to order.

Délai de fabrication: 5 semaines; tous les finitions RAL sont disponibles sur requête

Lieferzeit: 5 Wochen; zusätzlich zu den vorgeschlagenen Lackierungen sind alle Ausführungen der RAL-Skala verfügbar

GLASS TOPS/ PLATEAUX EN VERRE / GLASPLATTEN

12mm tempered back painted safety glass top finished with 1.5mm 45° polished edges.

Plateaux en verre ép. 12 mm, trempé et verni effet acidé.

Chants à fil lucide plat avec arrondi 1,5 mm x 45°.

Glasplatten 12 mm stark, gehärtet und lackiert mit satiniertem Effekt.

Flach polierte Kanten mit 1,5 mm x 45° Anfasung.



S1
Light green
Acidifîe
Hellblau

I*
White
Blanc
Weiss

* Back painted using scratch-resistant ceramic enamels

* Vernis sur le dessous avec émaux céramiques anti-rayures

* Auf der Unterseite mit kratzfesten Keramiklacken lackiert

METAL STRUCTURE / STRUCTURE EN MÉTAL / METALGESTELLE

Steel trumpet base leg made of a cone-shaped column (140mm max dia, 100mm min dia) and a Ø590mm 6mm steel molded base complete with seal to prevent marking. Metal plate linking top to the base. All parts supplied epoxy powder coated.

Tige en tube d'acier Ø 100 mm conique dans la partie inférieure et supérieure Ø 140 mm; plaque supérieure en acier pour fixation au plateau; base inférieure en tôle d'acier imprimée ép. 6 mm Ø 590 mm. Tout est verni à poudre époxy. Base inférieure avec joint transparent.

Gestell aus Stahlrohr Ø 100 mm, unten und oben konisch Ø 140 mm; obere Platte aus Stahl zur Befestigung an der Oberseite; untere Bodenplatte aus gepresstem Stahlblech Ø 6 mm, 590 mm stark. Alle Epoxy-Pulverbeschichtungen. Bodenplatte mit transparenter Dichtung.

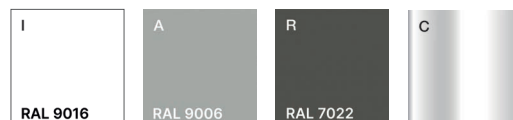

I
RAL 9016
White
Blanc
Weiss

A
RAL 9006
Silver
Aluminium
Alu

R
RAL 7022
Shadow grey
Gris ombre
Dunkelgrau

C
Chrome
Chromè
Verchromt

W	D	H	CODE	PTS	OPTIONS (PTS)	CBM	KGS	PARCELS
L	P	H	REF.	PTS	OPTIONS (PTS)	MC	KG	COLIS
B	T	H	ART. NR.		VARIANTEN (PTS)	M ³	KG	KOLLI

Montreal side table, circular melamine top

Table basse Montreal, plateau circulaire en mélaminé

Tisch Montreal, Rundplatte aus Melamin



					LA	BS	BD	TM			
460	460	500	MOTC0010	298	+30	+194	+218	+114	0,038	5,4	2
590	590	400	MOTC0020	308	+48	+230	+257	+120	0,050	6,8	2
1000	1000	300	MOTC0030	351	+138	+323	+366	+125	0,118	14,6	2

Montreal side table, square melamine top

Table basse Montreal, plateau carré en mélaminé

Tisch Montreal, Quaderplatte aus Melamin



					LA	BS	BD	TM			
410	410	500	MOTQ0010	297	+30	+182	+207	+114	0,037	5,6	2
520	520	400	MOTQ0020	305	+48	+218	+245	+120	0,048	7,1	2
875	875	300	MOTQ0030	334	+135	+331	+373	+125	0,076	14,3	2

Montreal side table, circular 3mm stoneware top

Table basse Montreal, plateau circulaire en grès ép. 3 mm

Tisch Montreal, Rundplatte aus Steinzeug Stärke 3mm



					BS	BD	TM			
460	460	503	MOTC3010	710	+194	+218	+114	0,041	6,8	2
590	590	403	MOTC3020	853	+230	+257	+120	0,054	9,1	2
1000	1000	303	MOTC3030	1350	+323	+366	+125	0,126	21,5	2

Montreal side table, square 3mm stoneware top

Table basse Montreal, plateau carré en grès ép. 3 mm

Tisch Montreal, Quaderplatte aus Steinzeug Stärke 3mm



					BS	BD	TM			
410	410	503	MOTQ3010	686	+182	+207	+114	0,039	6,8	2
520	520	403	MOTQ3020	801	+218	+245	+120	0,050	9,0	2
875	875	303	MOTQ3030	1241	+331	+373	+125	0,115	21,0	2

Montreal side table, circular 5mm stoneware top

Table basse Montreal, plateau circulaire en grès ép. 5 mm

Tisch Montreal, Rundplatte aus Steinzeug Stärke 5mm



					BS	BD	TM			
460	460	505	MOTC5010	784	+194	+218	+114	0,041	7,7	2
590	590	405	MOTC5020	1024	+230	+257	+120	0,054	10,5	2
1000	1000	305	MOTC5030	1720	+323	+366	+125	0,126	25,3	2

Montreal side table, square 5mm stoneware top

Table basse Montreal, plateau carré en grès ép. 5 mm

Tisch Montreal, Quaderplatte aus Steinzeug Stärke 5mm



					BS	BD	TM			
410	410	505	MOTQ5010	750	+182	+207	+114	0,039	7,6	2
520	520	405	MOTQ5020	852	+218	+245	+120	0,050	10,3	2
875	875	305	MOTQ5030	1565	+331	+373	+125	0,115	24,7	2

LA = Lacquered / Laqué / Lackiert

BS = Top with White (O) or Umbra Grey (R) decorative metal edges / Plateau avec chants décoratifs en métal Blanc (O) ou Gris Ombre (R) / Platte mit dekorativer Kante aus Metall, in Weiß (O) oder Dunkelgrau (R)

BD = Top with decorative metal edges in Gold (OR), Bronze (BR) or Corten (CR) / Plateau avec chants décoratifs en métal Or (OR), Bronze (BR) ou Corten (CR) / Platte mit dekorativer Kante aus Metall, in Gold (OR), Bronze (BR) oder Kupfer (CO)

TM = Gold (OR), Bronze (BR) or Corten (CR) frame / Cadre Or (OR), Bronze (BR) ou Corten (CR) / Gestell in Gold (OR), Bronze (BR) oder Kupfer (CO)

Coffee/café/poseur tables

Tables de café

Couchtische

W	D	H	CODE	PTS	OPTIONS (PTS)	CBM	KGS	PARCELS
L	P	H	REF.	PTS	OPTIONS (PTS)	MC	KG	COLIS
B	T	H	ART. NR.		VARIANTEN (PTS)	M ³	KG	KOLLI

Miami side table, circular melamine top

Table basse Miami, plateau circulaire en mélaminé

Tisch Miami, Rundplatte aus Melamin



					LA	BS	BD	TM			
460	460	500	MITC0010	270	+30	+194	+218	+88	0,049	5,6	2
590	590	400	MITC0020	285	+48	+230	+257	+104	0,065	7,0	2
1000	1000	300	MITC0030	346	+138	+323	+366	+125	0,146	15,1	2

Miami side table, asymmetric circular melamine top

Table basse Miami, plateau asymétrique circulaire en mélaminé

Tisch Melbourne, asymmetrische Rundplatte aus Melamin



					LA	BS	BD	TM			
460	460	500	MITC0040	317	+30	+194	+218	+104	0,049	6,0	2

Miami side table, square melamine top

Table basse Miami, plateau carré en mélaminé

Tisch Miami, Quaderplatte aus Melamin



					LA	BS	BD	TM			
410	410	500	MITQ0010	269	+30	+182	+207	+88	0,048	5,8	2
520	520	400	MITQ0020	282	+48	+218	+245	+104	0,063	7,3	2
875	875	300	MITQ0030	329	+135	+331	+373	+125	0,104	14,8	2

Miami side table, asymmetric square melamine top

Table basse Miami, plateau asymétrique carré en mélaminé

Tisch Melbourne, asymmetrische Quaderplatte aus Melamin



					LA	BS	BD	TM			
410	410	500	MITQ0040	316	+30	+182	+207	+104	0,048	6,2	2

Miami side table, circular 3mm stoneware top

Table basse Miami, plateau circulaire en grès ép. 3 mm

Tisch Miami, Rundplatte aus Steinzeug Stärke 3mm



					BS	BD	TM			
460	460	503	MITC3010	683	+194	+218	+88	0,052	7,0	2
590	590	403	MITC3020	830	+230	+257	+104	0,069	9,3	2
1000	1000	303	MITC3030	1345	+323	+366	+125	0,154	22,0	2

Miami side table, asymmetric circular 3mm stoneware top

Table basse Miami, plateau asymétrique circulaire en grès ép. 3 mm

Tisch Melbourne, asymmetrische Rundplatte aus Steinzeug Stärke 3mm



					BS	BD	TM			
460	460	503	MITC3040	729	+194	+218	+104	0,052	7,4	2

LA = Lacquered / Laqué / Lackiert

BS = Top with White (O) or Umbra Grey (R) decorative metal edges / Plateau avec chants décoratifs en métal Blanc (O) ou Gris Ombre (R) / Platte mit dekorativer Kante aus Metall, in Weiß (O) oder Dunkelgrau (R)

BD = Top with decorative metal edges in Gold (OR), Bronze (BR) or Corten (CR) / Plateau avec chants décoratifs en métal Or (OR), Bronze (BR) ou Corten (CR) / Platte mit dekorativer Kante aus Metall, in Gold (OR), Bronze (BR) oder Kupfer (CO)

TM = Gold (OR), Bronze (BR) or Corten (CR) frame / Cadre Or (OR), Bronze (BR) ou Corten (CR) / Gestell in Gold (OR), Bronze (BR) oder Kupfer (CO)

W	D	H	CODE	PTS	OPTIONS (PTS)	CBM	KGS	PARCELS
L	P	H	REF.	PTS	OPTIONS (PTS)	MC	KG	COLIS
B	T	H	ART. NR.	PTS	VARIANTEN (PTS)	M ³	KG	KOLLI

Miami side table, square 3mm stoneware top

Table basse Miami, plateau carré en grès ép. 3 mm

Tisch Miami, Quaderplatte aus Steinzeug Stärke 3mm



					BS	BD	TM			
410	410	503	MITQ3010	658	+182	+207	+88	0,050	7,0	2
520	520	403	MITQ3020	778	+218	+245	+104	0,065	9,2	2
875	875	303	MITQ3030	1236	+331	+373	+125	0,143	21,5	2

Miami side table, asymmetric square 3mm stoneware top

Table basse Miami, plateau asymétrique carré en grès ép. 3 mm

Tisch Melbourne, asymmetrische Quaderplatte aus Steinzeug Stärke 3mm



					BS	BD	TM			
410	410	503	MITQ3040	705	+182	+207	+104	0,050	7,4	2

Miami side table, circular 5mm stoneware top

Table basse Miami, plateau circulaire en grès ép. 5 mm

Tisch Miami, Rundplatte aus Steinzeug Stärke 5mm



					BS	BD	TM			
460	460	505	MITC5010	757	+194	+218	+88	0,052	7,9	2
590	590	405	MITC5020	1001	+230	+257	+104	0,069	10,7	2
1000	1000	305	MITC5030	1715	+323	+366	+125	0,154	25,8	2

Miami side table, asymmetric circular 5mm stoneware top

Table basse Miami, plateau asymétrique circulaire en grès ép. 5 mm

Tisch Melbourne, asymmetrische Rundplatte aus Steinzeug Stärke 5mm



					BS	BD	TM			
460	460	505	MITC5040	803	+194	+218	+104	0,052	8,3	2

Miami side table, square 5mm stoneware top

Table basse Miami, plateau carré en grès ép. 5 mm

Tisch Miami, Quaderplatte aus Steinzeug Stärke 5mm



					BS	BD	TM			
410	410	505	MITQ5010	723	+182	+207	+88	0,050	7,8	2
520	520	405	MITQ5020	829	+218	+245	+104	0,065	10,5	2
875	875	305	MITQ5030	1559	+331	+373	+125	0,143	25,2	2

Miami side table, asymmetric square 5mm stoneware top

Table basse Miami, plateau asymétrique carré en grès ép. 5 mm

Tisch Melbourne, asymmetrische Quaderplatte aus Steinzeug Stärke 5mm



					BS	BD	TM			
410	410	505	MITQ5040	770	+182	+207	+104	0,050	8,2	2

Miami vase holder

Conteneur Miami

Behälter Topfhalter Miami



						TM			
360	360	630	MIF00010	441		+149	0,079	8,0	2
460	460	570	MIF00020	510		+176	0,111	9,4	2

BS = Top with White (O) or Umbra Grey (R) decorative metal edges / Plateau avec chants décoratifs en métal Blanc (O) ou Gris Ombre (R) / Platte mit dekorativer Kante aus Metall, in Weiß (O) oder Dunkelgrau (R)
 BD = Top with decorative metal edges in Gold (OR), Bronze (BR) or Corten (CR) / Plateau avec chants décoratifs en métal Or (OR), Bronze (BR) ou Corten (CR) / Platte mit dekorativer Kante aus Metall, in Gold (OR), Bronze (BR) oder Kupfer (CO)
 TM = Gold (OR), Bronze (BR) or Corten (CR) frame / Cadre Or (OR), Bronze (BR) ou Corten (CR) / Gestell in Gold (OR), Bronze (BR) oder Kupfer (CO)

Pouf
Pouf
Pouf

W	D	H	CODE														
L	P	H	REF.				PTS							CBM	KGS	PARCELS	
B	T	H	ART. NR											M ³	KG	COLIS	
														M ³	KG	KOLLI	

Miami round pouf

Pouf Miami rond

Pouf Miami, rund



Upholstery / Revetement / Bezug

On Request / Sur requete / Auf Anfrage

				B01 B03	C01 C05	D02 D03 D05	E01	P01	D04 D06	E02 E03 E04	I01 I02	M01 M02 M03	TM				
485	485	470	MIPC0010	582	600	613	644	780	661	644	725	767	+104	0,102	6,4	2	
810	810	390	MIPC0020	870	901	925	981	1195	1011	981	1125	1200	+125	0,234	10,8	2	

Miami square pouf

Pouf Miami carré

Pouf Miami, quadratisch



Upholstery / Revetement / Bezug

On Request / Sur requete / Auf Anfrage

				B01 B03	C01 C05	D02 D03 D05	E01	P01	D04 D06	E02 E03 E04	I01 I02	M01 M02 M03	TM				
400	400	470	MIPQ0010	570	587	601	633	767	650	633	713	756	+104	0,102	6,1	2	
630	630	390	MIPQ0020	769	796	817	865	1052	891	865	990	1056	+125	0,234	9,4	2	

W	D	H	CODE	PTS	OPTIONS (PTS)	CBM	KGS	PARCELS
L	P	H	REF.	PTS	OPTIONS (PTS)	MC	KG	COLIS
B	T	H	ART. NR.		VARIANTEN (PTS)	M ³	KG	KOLLI

Melbourne side table, circular melamine top

Table basse Melbourne, plateau circulaire en mélaminé

Tisch Melbourne, Rundplatte aus Melamin



					LA	BS	BD			
460	460	500	METC0012	200	+30	+194	+218	0,015	3,19	2
460	460	400	METC0011	195	+30	+194	+218	0,015	3,04	2
460	460	300	METC0010	190	+30	+194	+218	0,015	2,92	2
590	590	500	METC0022	210	+48	+230	+257	0,021	4,59	2
590	590	400	METC0021	205	+48	+230	+257	0,021	4,44	2
590	590	300	METC0020	199	+48	+230	+257	0,021	4,32	2
1000	1000	300	METC0030	236	+138	+323	+366	0,047	10,92	2

Melbourne side table, square melamine top

Table basse Melbourne, plateau carré en mélaminé

Tisch Melbourne, Quaderplatte aus Melamin



					LA	BS	BD			
410	410	500	METQ0012	239	+30	+182	+207	0,014	3,62	2
410	410	400	METQ0011	231	+30	+182	+207	0,014	3,42	2
410	410	300	METQ0010	224	+30	+182	+207	0,014	3,26	2
520	520	500	METQ0022	246	+48	+218	+245	0,018	5,12	2
520	520	400	METQ0021	239	+48	+218	+245	0,018	4,92	2
520	520	300	METQ0020	231	+48	+218	+245	0,018	4,76	2
875	875	300	METQ0030	254	+135	+331	+373	0,006	10,76	2

Melbourne side table, circular 3mm stoneware top

Table basse Melbourne, plateau circulaire en grès ép. 3 mm

Tisch Melbourne, Rundplatte aus Steinzeug Stärke 3mm



					BS	BD			
460	460	503	METC3012	392	+194	+218	0,018	4,59	2
460	460	403	METC3011	387	+194	+218	0,018	4,44	2
460	460	303	METC3010	382	+194	+218	0,018	4,32	2
590	590	503	METC3022	462	+230	+257	0,024	6,89	2
590	590	403	METC3021	457	+230	+257	0,024	6,74	2
590	590	303	METC3020	452	+230	+257	0,024	6,62	2
1000	1000	303	METC3030	764	+323	+366	0,055	17,82	2

Melbourne side table, square 3mm stoneware top

Table basse Melbourne, plateau carré en grès ép. 3 mm

Tisch Melbourne, Quaderplatte aus Steinzeug Stärke 3mm



					BS	BD			
410	410	503	METQ3012	414	+182	+207	0,015	4,82	2
410	410	403	METQ3011	407	+182	+207	0,015	4,62	2
410	410	303	METQ3010	400	+182	+207	0,015	4,46	2
520	520	503	METQ3022	478	+218	+245	0,021	7,02	2
520	520	403	METQ3021	471	+218	+245	0,021	6,82	2
520	520	303	METQ3020	463	+218	+245	0,021	6,66	2
875	875	303	METQ3030	711	+331	+373	0,044	17,46	2

LA = Lacquered / Laqué / Lackiert

BS = Top with White (O) or Umbra Grey (R) decorative metal edges / Plateau avec chants décoratifs en métal Blanc (O) ou Gris Ombre (R) / Platte mit dekorativer Kante aus Metall, in Weiß (O) oder Dunkelgrau (R)

BD = Top with decorative metal edges in Gold (OR), Bronze (BR) or Corten (CR) / Plateau avec chants décoratifs en métal Or (OR), Bronze (BR) ou Corten (CR) / Platte mit dekorativer Kante aus Metall, in Gold (OR), Bronze (BR) oder Kupfer (CO)

Coffee/café/poseur tables

Tables de café

Couchtische

W	D	H	CODE	PTS	OPTIONS (PTS)	CBM	KGS	PARCELS
L	P	H	REF.	PTS	OPTIONS (PTS)	MC	KG	COLIS
B	T	H	ART. NR.		VARIANTEN (PTS)	M ³	KG	KOLLI

Melbourne side table, circular 5mm stoneware top

Table basse Melbourne, plateau circulaire en grès ép. 5 mm

Tisch Melbourne, Rundplatte aus Steinzeug Stärke 5mm



					BS	BD			
460	460	505	METC5012	424	+194	+218	0,018	5,49	2
460	460	405	METC5011	419	+194	+218	0,018	5,34	2
460	460	305	METC5010	413	+194	+218	0,018	5,22	2
590	590	505	METC5022	516	+230	+257	0,024	8,29	2
590	590	405	METC5021	511	+230	+257	0,024	8,14	2
590	590	305	METC5020	506	+230	+257	0,024	8,02	2
1000	1000	305	METC5030	940	+323	+366	0,055	21,62	2

Melbourne side table, square 5mm stoneware top

Table basse Melbourne, plateau carré en grès ép. 5 mm

Tisch Melbourne, Quaderplatte aus Steinzeug Stärke 5mm



					BS	BD			
410	410	505	METQ5012	446	+182	+207	0,015	5,62	2
410	410	405	METQ5011	439	+182	+207	0,015	5,42	2
410	410	305	METQ5010	431	+182	+207	0,015	5,26	2
520	520	505	METQ5022	505	+218	+245	0,021	8,32	2
520	520	405	METQ5021	497	+218	+245	0,021	8,12	2
520	520	305	METQ5020	490	+218	+245	0,021	7,96	2
875	875	305	METQ5030	865	+331	+373	0,044	21,16	2

Melbourne vase holder

Conteneur Melbourne

Behälter Topfhalter Melbourne



					TM			
360	360	430	MEF00010	360	+61	0,045	5,32	2
360	360	530	MEF00011	366	+61	0,045	5,44	2
360	360	630	MEF00012	371	+61	0,045	5,59	2
460	460	470	MEF00020	424	+72	0,067	6,72	2
460	460	570	MEF00021	429	+72	0,067	6,84	2
460	460	670	MEF00022	435	+72	0,067	6,99	2

BS = Top with White (O) or Umbra Grey (R) decorative metal edges / Plateau avec chants décoratifs en métal Blanc (O) ou Gris Ombre (R) / Platte mit dekorativer Kante aus Metall, in Weiß (O) oder Dunkelgrau (R)

BD = Top with decorative metal edges in Gold (OR), Bronze (BR) or Corten (CR) / Plateau avec chants décoratifs en métal Or (OR), Bronze (BR) ou Corten (CR) / Platte mit dekorativer Kante aus Metall, in Gold (OR), Bronze (BR) oder Kupfer (CO)

TM = Gold (OR), Bronze (BR) or Corten (CR) frame / Cadre Or (OR), Bronze (BR) ou Corten (CR) / Gestell in Gold (OR), Bronze (BR) oder Kupfer (CO)

W	D	H	CODE							CBM	KGS	PARCELS
L	P	H	REF.				PTS			M ³	KG	COLIS
B	T	H	ART. NR							M ³	KG	KOLLI

Melbourne round pouf

Pouf Melbourne rond

Pouf Melbourne, rund



Upholstery / Revêtement / Bezug

On Request / Sur requete / Auf Anfrage

				B01	C01	D02				D04	E02	I01	M01				
				B03	C05	D03	E01	P01		D06	E04	I02	M02				
						D05							M03				
485	485	370	MEPC0010	497	515	528	560	695		577	560	640	683		0,068	3,9	2
485	485	470	MEPC0011	490	508	520	552	688		569	552	633	675		0,068	4,0	2
810	810	390	MEPC0020	796	827	851	906	1120		937	906	1050	1126		0,189	8,3	2

Melbourne square pouf

Pouf Melbourne carré

Pouf Melbourne, quadratisch



Upholstery / Revêtement / Bezug







On Request / Sur requete / Auf Anfrage

				B01	C01	D02				D04	E02	I01	M01				
				B03	C05	D03	E01	P01		D06	E04	I02	M02				
						D05							M03				
400	400	370	MEPQ0010	485	502	516	548	683		565	548	629	671		0,068	3,6	2
400	400	470	MEPQ0011	478	495	509	541	675		558	541	621	664		0,068	3,7	2
630	630	390	MEPQ0020	694	722	743	791	977		817	791	916	982		0,189	6,9	2

Coffee/café/poseur tables

Tables de café

Couchtische

	W	D	H	CODE	PTS	OPTIONS (PTS)	CBM	KGS	PARCELS
	L	P	H	REF.		OPTIONS (PTS)	MC	KG	COLIS
	B	T	H	ART. NR.		VARIANTEN (PTS)	M ³	KG	KOLLI
				Cozy, three-leg metal table, circular top Cozy, table 3 pieds en métal, plateau circulaire Cozy, tisch 3 Beine Metall, Rundplatte					
	60	60	50	OTAVOT08	276	LA +47 PH +164 TM +131	0,200	12,0	1
	Supplement powder coated frame in a special finish (minimum 2 units) / Supplement pour cadre en coloris spéciaux (à partir de 2 pièces) / Zuschlag Lackierung Gestell auf Anfrage (mindestens 2 Stück) 81 PTS								
				Cozy, three-leg metal table, circular top Cozy, table 3 pieds en métal, plateau circulaire Cozy, tisch 3 Beine Metall, Rundplatte					
	69	69	75	OTAVOT07	282	LA +64 PH +162 TM +153	0,080	10,0	1
	Supplement powder coated frame in a special finish (minimum 2 units) / Supplement pour cadre en coloris spéciaux (à partir de 2 pièces) / Zuschlag Lackierung Gestell auf Anfrage (mindestens 2 Stück) 101 PTS								
				Cozy, four-leg metal table, circular top Cozy, table 4 pieds en métal, plateau circulaire Cozy, tisch 4 Beine Metall, Rundplatte					
	100	100	75	OTAVOT12	389	LA +129 PH +376 TM +153	0,400	23,0	1
	Supplement powder coated frame in a special finish (minimum 2 units) / Supplement pour cadre en coloris spéciaux (à partir de 2 pièces) / Zuschlag Lackierung Gestell auf Anfrage (mindestens 2 Stück) 101 PTS								
				Cozy, four-leg metal table, square top Cozy, table 4 pieds en métal, plateau carré Cozy, tisch 4 Beine Metall, Quaderplatte					
	69	69	75	OTAVOT13	358	LA +78 PH +214 TM +153	0,400	23,0	1
	Supplement powder coated frame in a special finish (minimum 2 units) / Supplement pour cadre en coloris spéciaux (à partir de 2 pièces) / Zuschlag Lackierung Gestell auf Anfrage (mindestens 2 Stück) 101 PTS								
				Cozy, four-leg wooden table, square top Cozy, table 4 pieds en bois, plateau carré Cozy, tisch 4 Beine Holz, Quaderplatte					
	69	69	75	OTAVOT10	482	LA +78 PH +212	0,040	14,0	1
	Supplement powder coated frame in a special finish (minimum 2 units) / Supplement pour cadre en coloris spéciaux (à partir de 2 pièces) / Zuschlag Lackierung Gestell auf Anfrage (mindestens 2 Stück) 120 PTS								
				Cozy, three-leg wooden table, circular top Cozy, table 3 pieds en bois, plateau circulaire Cozy, tisch 3 Beine Holz, Rundplatte					
	100	100	75	OTAVOT11	428	LA +129 PH +370	0,050	17,0	1
	Supplement powder coated frame in a special finish (minimum 2 units) / Supplement pour cadre en coloris spéciaux (à partir de 2 pièces) / Zuschlag Lackierung Gestell auf Anfrage (mindestens 2 Stück) 92 PTS								

TM = Gold (OR), Bronze (BR) or Corten (CR) frame / Cadre Or (OR), Bronze (BR) ou Corten (CR) / Gestell in Gold (OR), Bronze (BR) oder Kupfer (CO)

LA = Lacquered / Laqué / Lackiert

PH = 10mm white HPL top / Plateau en HPL blanc ép. 10 mm / Weiss HPL-Platte St.10mm

W	D	H	CODE	PTS	OPTIONS (PTS)	CBM	KGS	PARCELS
L	P	H	REF.	PTS	OPTIONS (PTS)	MC	KG	COLIS
B	T	H	ART. NR.	PTS	VARIANTEN (PTS)	M ³	KG	KOLLI

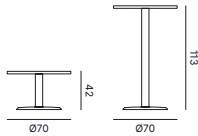

T01 coffee/poseur tables with circular melamine top & round column base

Table T01 plateau rond mélaminé, pied colonne et base ronde métal

T01 Tische Bikonisches Gestell, Platte melaminbeschichtet rund

W	D	H	CODE	PTS	OPTIONS (PTS)	CBM	KGS	PARCELS
70	70	42	CTTO704	352	LA +64	0,063	21,5	3
70	70	113	CTTO711	386	LA +64	0,086	23,0	3

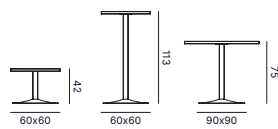

T02 coffee/café/poseur tables with square melamine top & square column base

Table T02 plateau carré mélaminé, pied carré et base pyramidale métal

T02 Tische Säulenfuß und pyramidenförmige Bodenplatte

W	D	H	CODE	PTS	OPTIONS (PTS)	CBM	KGS	PARCELS
60	60	42	CTPI604	296	LA +59	0,069	28,0	3
60	60	113	CTPI611	313	LA +59	0,085	29,0	3
90	90	75	CTPI907	330	LA +134	0,108	34,0	3

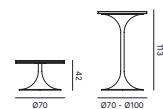

T03 coffee/café/poseur tables with circular melamine top & single-piece trumpet base

Table T03 plateau rond mélaminé, base biconique

T03 Tische Bikonisches Gestell, Platte melaminbeschichtet rund

W	D	H	CODE	PTS	OPTIONS (PTS)	CBM	KGS	PARCELS
70	70	42	CTBI704	614	LA +64	0,209	13,0	2
70	70	113	CTBI711	1072	LA +64	0,484	22,0	2
100	100	113	CTBI111	1099	LA +129	0,515	29,5	2



T05 coffee tables with melamine top linked to its melamine base using 45° mitred joints

Table T05 mélaminé avec angles de liaison 45°

T05 Tische 45° Ecke

W	D	H	CODE	PTS	OPTIONS (PTS)	CBM	KGS	PARCELS
70	70	26	CT45207	568	LA +214	0,074	28,0	2
100	100	26	CT45210	694	LA +358	0,110	50,0	2
140	70	26	CT45214	694	LA +371	0,128	58,0	2

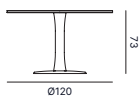

T06 café table with circular melamine top on a metal trumpet base leg

Table T06 plateau rond mélaminé, pied colonne et base rond métal

T06 Tische Säulenfuß und runde Bodenplatte, Melaminplatte

W	D	H	CODE	PTS	OPTIONS (PTS)	CBM	KGS	PARCELS
120	120	73	CTCP112	669	C +577 LA +186	0,140	46,0	4

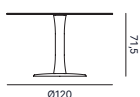

T06 café table with circular glass top on a metal trumpet base leg

Table T06 plateau rond en verre, pied colonne et base rond métal

T06 Tische Säulenfuß und runde Bodenplatte. Glasplatte

W	D	H	CODE	PTS	OPTIONS (PTS)	CBM	KGS	PARCELS
120	120	71,5	CTCV112	1685	C +577 V2 +283	0,139	63,5	3

LA = Lacquered / Laqué / Lackiert

C = Chrome frame / Structure en chrome / Gestell verchromt

V2 = Extraclear glass back painted in white (I) / Verre extra clair finition blanc (I) / Glas extra-klar Ausführung weiss

FLIPPER

designed by Edi & Paolo Ciani



SLIDING TOP / PLATEAU COULISSANT / SCHIEBEPLATTE

12mm easy to clean scratch-resistant anti-reflective melamine faced chipboard (MFC) top finished with 1mm matching straight ABS impact resistant edges. The top slides towards the user 228mm to allow access to the storage below.

Anodised aluminium drawer runners 9mm high, with sliding component in high quality zinc alloy Zama with coated in lubricant polymer. Polypropylene caps on the end of the slides.

Plateau en aggloméré ép. 12 mm, revêtu sur deux cotés avec papier de mélamine anti-rayures et antireflet; chants droits en ABS antichoc sur les 4 cotés assortis au plan, ép. 1mm.

Le plateau coulisse vers l'opérateur de 228 mm pour pouvoir accéder au porte-objets.

Coulissement à travers de guides h.9mm, en profil d'aluminium anodisé et patins pressé en zama avec revêtement externe en technopolymère autolubrifiant. Bouchons de fermeture dans les guides et arrêts en polypropylène imprimé.

Platte aus 12 mm starkem Holzkonglomerat, beidseitig mit reflexfreiem, kratzfestem und waschbarem Melaminpapier belegt. 4-seitig aus schlagfestem ABS, in der gleichen Farbe, Stärke 1 mm.

Die Tischplatte kann man in die Richtung des Benutzers um 228mm schieben, um Zugriff zum Behälter zu gewährleisten.

Gleiten durch 9 mm hohe Führungen aus eloxiertem Aluminiumprofil und geformten Zamak-Kufen mit selbstschmierender Technopolymer-Außenhülle. Endkappen für den Schienenkopf und geformte Anschläge aus Polypropylen.

Finishes
Finitions
Ausführungen

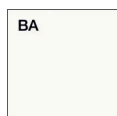

White
Blanc
Weiss

STORAGE SHELL / PORTE-OBJETS / BEHÄLTER

Shell made of two layers; the external shell made 100% in polypropylene and an inner tray reinforced with 20% fibre glass and polypropylene. The bottom of the tray is designed with grooves and two holes for the passage of electric cables. The grommet holes come with covers in ABS plastic, 52mm diameter. The storage tray includes fixings for the book stand and for the optional socket outlet.

Coque composée par deux coquilles moulées: une externe en polypropylène avec surface à vue goffré et une interne en polypropylène avec fibre de verre au 20%. Rainures moulées sur le fond pour le logement des câbles électriques et deux trous de 52 mm de diamètre, avec couvercle amovible en ABS, pour le passage extérieur des câbles électriques. Coque équipée pour la fixation du pupitre et de la prise électrique en option.

Das Gehäuse besteht aus zwei Schalen: einer Außenschale in Polypropylen mit geprägten sichtbaren Oberflächen und einer Innenschale in Polypropylen, mit 20% Glasfaser verstärkt. Geformte Rillen auf der Unterseite zur Aufnahme von Elektrokabeln und zwei Löcher mit 52 mm Durchmesser, mit abnehmbarer ABS-Abdeckung, für die externe Durchführung von Elektrokabeln.

Das Gehäuse ist für die Befestigung des Buchständers und der optionalen Steckdose vorbereitet.

Finishes
Finitions
Ausführungen

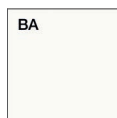

White
Blanc
Weiss

BOOK STAND (OPTIONAL) / PUPITRE (EN OPTION) / BUCH- UND TABLETSTÄNDER (OPTIONAL)

Made in a sheet of folded and epoxy painted steel. It is fixed to the tray with rotating hinges in anodised aluminium (122 degrees movement) The sliding top needs to be moved to allow access to the stand. Which can be folded and hidden inside the tray or turned upright easily.

Réalisé en tôle d'acier pliée, revêtue de poudre époxy, fixé à la coque par des charnières à friction en aluminium anodisé, orientable à 122°. Il peut être replié sur lui-même à l'intérieur du compartiment ou exposé si nécessaire en le faisant pivoter à l'extérieur lorsque le plateau est ouvert.

Aus gefaltetem, epoxidpulverbeschichtetem Stahlblech, mit Scharnieren aus eloxiertem Aluminium kraftschlüssig an der Schale befestigt, mit 122° Drehung. Er kann im Behälter zurückgeklappt werden oder bei Bedarf durch Drehen nach außen freigelegt werden, wenn die Tischplatte geöffnet ist.

Finishes
Finitions
Ausführungen

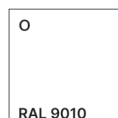

Matt white
Blanc mat
Weiss matt



Umbra Grey
Gris ombre
Dunkelgrau

Depending on the surface the color may vary slightly from the reference (RAL / NCS) provided.
En fonction de la surface, la couleur peut varier légèrement par rapport à la référence (RAL / NCS) fournie.
Je nach Oberfläche kann die Farbe in Bezug auf die RAL/NCS Referenz abweichen.

Specification sheet

Caractéristiques techniques

Technische Beschreibungen

PLINTH WITH FLAT BASE / STRUCTURE AVEC PIED ET BASE / GESTELL MIT SÄULENFUSS

Tubular central steel column in 60mm diameter, 1.5mm thick. It features a top rectangular steel plate 4mm thick, welded. And ascrew on, base plate in steel, 10mm thick. All components epoxy powder coated. The top and bottom plates are pre-drilled and allow cables to run down through the central column. the flat base comes with no4 rubber feet.

Montant en tube d'acier diamètre 60 mm, ép. 1,5 mm soudé dans la partie supérieur une plaque rectangulaire en tôle d'acier ép. 4 mm et avec vissé dans la partie arrondie, en tôle d'acier ép 10 mm. Le tout est verni en poudre epoxy. La plaque supérieur au centre et le montant dans la partie inférieur, present des trous circulaire pour faire passer les cables electriques du dessus au sol par le pied. La base a 4 patins en caotchou anti-glisement.

Stahlrohrständer, 60 mm Durchmesser, 1,5 mm stark, mit einer rechteckigen, 4 mm starken Stahlplatte, die oben angeschweißt ist, und einer geformten, 10 mm starken Stahlplatte, die unten angeschraubt ist. Das Ganze ist Epoxidpulverbeschichtet. Die obere Platte in der Mitte und der Pfosten im unteren Teil sind mit kreisförmigen Löchern versehen, um die elektrischen Kabel von oben durch das Bein zum Boden zu führen. Das Gestell ist mit 4 rutschfesten Gummipads ausgestattet.



4 LEGGED FRAME / STRUCTURE 4 PIEDS / 4-FUSSGESTELL

Frame made of two tubular steel elements 18mm diameter and 2mm thick, folded in a U shape and connected by welded cross bars to form the 4 legs. At the top the frame features pre drilled steel plates 4mm thick that allow the passage of cables into the storage shell. Articulated feet in nylon with interchangeable glides to suit different floor materials.

Structure composée de deux éléments tubulaires en acier de 18 mm de diamètre et de 2 mm d'épaisseur, pliés pour former quatre pieds inclinés avec des traverses horizontales soudées dans la partie inférieure et des plaques rectangulaires dans la partie supérieure. Les plaques sont constituées d'une tôle d'acier de 4 mm d'épaisseur avec un trou circulaire au centre pour la descente des câbles électriques depuis l'intérieur du compartiment de la coque. Les pieds sont équipés de patins articulés en nylon avec des inserts interchangeables dans la partie inférieure, réalisés en feutre de laine et en matériau thermoplastique lisse, adaptés à différents types de sols.

Struktur bestehend aus zwei Stahlrohrelementen mit einem Durchmesser von 18 mm und einer Stärke von 2 mm, die so gebogen sind, dass sie vier schräge Beine mit geschweißten horizontalen Querstreben im unteren Teil und rechteckigen Platten im oberen Teil bilden. Die Platten bestehen aus 4 mm starkem Stahlblech mit einem kreisförmigen Loch in der Mitte, durch das die elektrischen Kabel aus der Schale herabgelassen werden. Die Beine sind mit gelenkigen Nylonfüßen mit austauschbaren Einsätzen im unteren Teil ausgestattet, die aus Wollfilz und glattem thermoplastischem Material bestehen und für verschiedene Bodenarten geeignet sind.



Finishes

Finitions

Ausführungen



Matt white

Blanc mat

Weiss matt

Umbr Grey

Gris ombre

Dunkelgrau

Depending on the surface the color may vary slightly from the reference (RAL / NCS) provided.

En fonction de la surface, la couleur peut varier légèrement par rapport à la référence (RAL / NCS) fournie.

Je nach Oberfläche kann die Farbe in Bezug auf die RAL/NCS Referenz abweichen.

SOCKET (OPTIONAL) / PRISE ELECTRIQUE (EN OPTION) / ELEKTRISCHE STECKDOSE (OPTIONAL)

The Electrical socket with a plastic outer body is designed to be fixed with screws to the tray.

Socket layout - one UK power outlet and one USB 5V. Inclusive of 2 meter cable with plug





Prise électrique avec coque en plastique à fixer sur le fond par de vis.

Configuré avec un fruit et un USB 5V et équipé d'un câble d'alimentation de 2 m de long.

Elektrische Steckdose mit Plastikschale zur Befestigung durch Schrauben.

Konfiguration: 1x Schuko und 1x USB 5V, mit 2m langem Stromkabel.

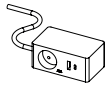
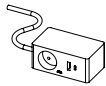

	W	D	H	CODE	PTS	OPTIONS (PTS)	CBM	KGS	PARCELS
	L	P	H	REF.		OPTIONS (PTS)	MC	KG	COLIS
	B	T	H	ART. NR.		VARIANTEN (PTS)	M ³	KG	KOLLI
				Flipper, home office table with sliding top and glove compartment, middle structural leg Flipper, table home office avec plateau coulissant et niche porte-objets, pied central <i>Flipper, Tisch für Home Office mit Schiebeplatte und Behälter, Säulengestell</i>					
	72,5	43	76	FLTA0001	1057		0,096	26,4	3
				Flipper, home office table with sliding top and glove compartment, 4 legs structure Flipper, table home office avec plateau coulissant et niche porte-objets, structure 4 pieds <i>Flipper, Tisch für Home Office mit Schiebeplatte und Behälter, 4-Fußgestell</i>					
	72,5	43	76	FLTA0002	997		0,155	17,5	2
				Book stand Pupitre <i>Buch- und Tabletständer</i>					
	38	15	0,2	FLLE0001	127		0,003	1,5	1
				Extendable ABS cable spine Vertebre passe-câbles en ABS <i>Vertikaler Kabelkanal ABS matt</i>					
	8	4	81	COVR0081	69		0,006	0,5	1
				Chromed steel extendable cable spine Passe cables vertical <i>Vertikaler Kabelkanal Helix</i>					
	12,5	12,5		FECNHE01	199		0,004	1,2	1
	<small>Available in chrome Disponible en finition chromé In der Farbe verchromt</small>								
				CE socket with 5V USB Boite électrique CE avec prise et un USB 5v <i>Steckdosenleiste CE mit 1x Schuko Steckdose und 1x USB 5V</i>					
	12	7	6	PCVQCE01	159		0,004	1,0	1
				UK socket with 5V USB Boite électrique UK avec prise et un USB 5v <i>Steckdosenleiste UK mit 1x UK Steckdose und 1x USB 5V</i>					
	12	7	6	PCVQUK01	178		0,004	1,0	1

PETAL&CLOAK

designed by Quadrifoglio Group



ACOUSTIC PANELS / PANNEAU ACOUSTIQUE / SCHALLABSORBIERENDE PLATTE

Thermoformed polyester fibre panel, upholstered with fire retardant fabric made from Trevira CS 100% polyester in a variety of finish options.

Panneau en fibre de polyester thermoformé, revêtu en tissu Trevira CS en différentes finitions.

Platte aus thermogeformter Polyesterfaser, bezogen mit Trevira CS-Gewebe in verschiedenen Farben.

Finishes

Finitions

Ausführungen



5 week production lead time, exclusive of delivery, for non-stock fabrics.

Apart from the shown finish options any B01 color can be made to order: price will not change for orders of min 4 units or multiples of 4 (8, 12, 16, etc.)

Pour les tissus pas en stock délai de fabrication: 5 semaines. Différentes tissus B01 disponibles sur requête: le prix ne change pas pour commandes de 4 pièces ou multiples (4,12,16 etc)

Für die Stofffarben, die nicht am Lager sind, produktionszeit: 5 Wochen.

Zusätzlich zu den vorgeschlagenen Ausführungen sind alle Stoffe B01 auf Anfrage erhältlich: der Preis ändert sich nicht bei Bestellungen von 4 Stück oder Vielfachen (8, 12, 16, etc.).

Available in C05 fabric

Disponible en tissu C05

Verfügbar in Stoff C05

Cloak + 34 €

Petal + 69 €

FRAME / CADRE / GESTELL

Finishes

Finitions

Ausführungen

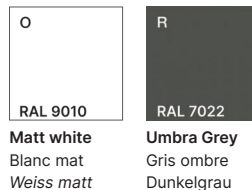





Matt white
Blanc mat
Weiss matt

Umbra Grey
Gris ombre
Dunkelgrau

Depending on the surface the color may vary slightly from the reference (RAL / NCS) provided.

En fonction de la surface, la couleur peut varier légèrement par rapport à la référence (RAL / NCS) fournie.

Je nach Oberfläche kann die Farbe in Bezug auf die RAL/NCS Referenz abweichen.

	W	D	H	CODE	PTS	OPTIONS (PTS)	CBM	KGS	PARCELS
	L	P	H	REF.		OPTIONS (PTS)	MC	KG	COLIS
	B	T	H	ART. NR.		VARIANTEN (PTS)	M ³	KG	KOLLI
	Petal floor stand Base Petal <i>Schalldämpfender Raumteiler Petal</i>			KN8FS00X00	1621		0,429	26,8	4
	174	40	185						
	2 Cloak vertical panels 2 Panneau Cloak verticales <i>2 Paneele Cloak Vertikale</i>			KN8PF00X04	554		0,185	3,6	3
	71	4	145						
	3 Cloak vertical panels 3 Panneau Cloak verticales <i>3 Paneele Cloak Vertikale</i>			KN8PF00X05	754		0,246	4,8	4
	71	4	198						
	4 Cloak vertical panels 4 Panneau Cloak verticales <i>4 Paneele Cloak Vertikale</i>			KN8PF00X06	953		0,308	6,0	5
	71	4	251						
	5 Cloak vertical panels 5 Panneau Cloak verticales <i>5 Paneele Cloak Vertikale</i>			KN8PF00X07	1152		0,369	7,2	6
	71	4	304						

W	D	H	CODE	PTS	OPTIONS (PTS)	CBM	KGS	PARCELS
L	P	H	REF.		OPTIONS (PTS)	MC	KG	COLIS
B	T	H	ART. NR.		VARIANTEN (PTS)	M ³	KG	KOLLI

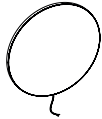
**Alter Ego, round backlit mirror (IP44 - 3000K)**

Alter Ego, miroir circulaire rétro-éclairé (IP44 - 3000K)

Alter Ego, Rundspiegel mit Hintergrundbeleuchtung (IP44 - 3000K)

600	600	40	ALSP0001	428		0,018	5,1	1
800	800	40	ALSP0002	523		0,031	7,4	1
1000	1000	40	ALSP0003	694		0,047	10,3	1

Edge available in White (O) or Black (N)

Chant perimetrale disponible en finition blanc (O) et noir (N)

Rahmen in Weiß (O) und Schwarz (N) verfügbar



Index

Living Tables	251	NINE
	255	EIGHT
	259	SEVEN
	265	SIX
	269	FIVE
	273	THREE
	277	TWO
	281	CREO & GREKO

NINE

designed by Gabriel Polloni Associati



TOPS / PLAN / TISCHPLATTEN

Made of 18mm veneered MDF board, matt transparent semi-open pore varnished 0.6mm wood veneer, 1mm wood veneer edging, front and back of top are 90° folded to form 50mm high side edges whose grain, being part of the same board, lines up perfectly with the top. Panel density 720/790 kgs/m³

Realisés en aggloméré ép. 18 mm, en placage bois épaisseur 0,6 mm, avec les côtés longitudinaux travaillés à folding pour avoir des bandes de hauteur 50 mm dans un seul pièce, avec chants périphériques en bois ép. 1 mm, coins rayonnés 0,5 mm et verni transparent mat à pore semi-ouvert. Densité panneau: 720/790 kg/m³

Hergestellt aus 18 mm starken Holzkonglomeratplatten (mdf), furniert mit 0,6 mm starkem Holz und gearbeitet, die Längsseiten zu 50 mm hohen Bändern aus einem Stück gefaltet, mit Holzkanten 1 mm stark, abgerundeten Kanten 0,5 mm und transparenter Lackierung halboffener-porig. Plattendichte: 720/790 kg/m³

Finishes

Finitions

Ausführungen

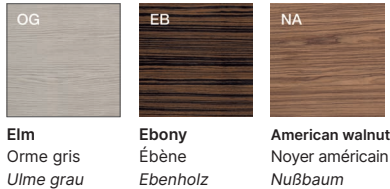

METAL FRAME / STRUCTURE MÉTALLIQUE / METALGESTELLE

Epoxy powder coated steel frame.

Structure en tôle d'acier verni à poudre époxy.

Gestell aus epoxidpulverbeschichtetem Stahlblechprofil.

Finishes

Finitions

Ausführungen

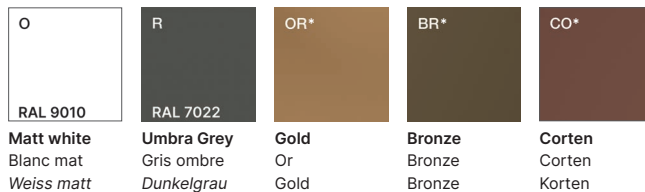

* Production lead time: 5 weeks exclusive of delivery time

Délai de fabrication: 5 semaines

Lieferzeit: 5 Wochen

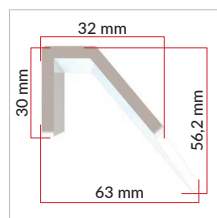

Tapered legs made of 4mm steel open sections, cross section tapers from 30×32mm (lower end) to 63×56.2mm (upper end)

Pied en tôle d'acier décapé. Section inférieure 30×32 mm (supérieure 63×56,2mm), ép. 4 mm.

Fuß aus gebeiztem Stahlblechprofil 4 mm stark. Unterteil 30×32mm (Oberteil 63×56,2mm).

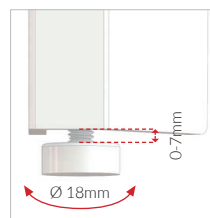

0-7mm adjustable levelling feet made of grey polyethylene, 18mm diameter.

Vérins de réglage en polyéthylène, gris, Ø 18mm, avec réglage 0-7 mm.

Polyethylen-Nivellierfuß, Farbe grau, Ø 18mm, mit Verstellung 0-7 mm.

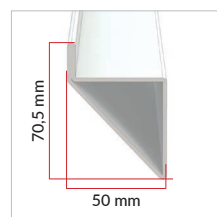

Crossbar between legs made of 50×70.5mm 2mm steel hollow tube, beams are fitted using steel brackets welded to crossbar.

Traverse du pied en tube profilé décapé, section 50×70,5 mm ép. 2 mm avec soudés des joints pour fixation des poutres.

Querträger aus gebeiztem Profilrohr, Querschnitt 50×70,5 mm, Stärke 2 mm, mit angeschweißten verdeckten Kupplungen zum Einsetzen von Trägern.

Depending on the surface the color may vary slightly from the reference (RAL / NCS) provided.

En fonction de la surface, la couleur peut varier légèrement par rapport à la référence (RAL / NCS) fournie.

Je nach Oberfläche kann die Farbe in Bezug auf die RAL/NCS Referenz abweichen.

Nine tables
Tables Nine
Tische Nine

W	D	H	CODE		OPTIONS (PTS)	CBM	KGS	PARCELS
L	P	H	REF.	PTS	OPTIONS (PTS)	MC	KG	COLIS
B	T	H	ART. NR.		VARIANTEN (PTS)	M ³	KG	KOLLI

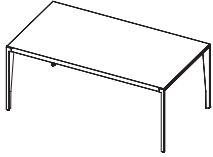

Table with wood veneer top

Table avec plateau en plaçage bois

Tisch mit Platte furniert

					TM			
161	101	75	L09SCL16	2116	+164	0,379	50,5	4
181	101	75	L09SCL18	2213	+164	0,379	54,6	4
201	101	75	L09SCL20	2310	+164	0,407	59,4	4
221	101	75	L09SCL22	2406	+164	0,407	64,3	4

EIGHT

designed by Quadrifoglio Group R&D dept.



MELAMINE TOPS / PLATEAUX EN MÉLAMINE / TISCHPLATTEN AUS MELAMIN

18mm easy to clean scratch-resistant anti-reflective melamine faced chipboard (MFC) top. 10mm high chamfered edges finished with 1mm impact resistant matching Abs. MFC tops are partly embedded in the desk perimeter frame, only the 10mm chamfered edge shows.
Panel density: 670/730 kgs per cubic meter.



Plan de travail en aggloméré en ép. 18 mm, revêtu sur deux cotés avec papier mélaminé mat anti-rayures et antireflet; avec formage tout au long du périmètre avec une épaisseur de 10 mm. Les chants droits sont en ABS en 1 mm antichoc sur les 4 cotés assortis au plan.
Densité panneau: 670/730 kg/m³

Aus 18 mm starkem Holzkonglomerat, mit Melaminpapier überzogen, kratzfest und reflexfrei, mit 4 Seiten H. 10 mm aus ABS 1 mm stark.
Plattendichte: 670/730 kg/m³

Finishes

Finitions

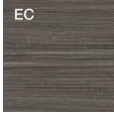
Ausführungen

BA 	EC 	OL 	NO 
White Blanc Weiss	Eucalyptus Eucalyptus Eukalyptus	Elm Orme Ulme	Canaletto Walnut Noyer Canaletto Nuss Canaletto

LACQUERED MELAMINE TOPS / PLATEAUX EN MÉLAMINE LAQUÉ / TISCHPLATTEN AUS MELAMIN, LACKIERT

18mm scratch & abrasion resistant lacquered melamine faced chipboard (MFC) top. 10mm high chamfered edges finished with 1mm impact resistant matching Abs. Matt lacquers. Lacquered tops are partly embedded in the desk perimeter frame, only the 10mm chamfered edge shows.
Panel density: 670/730 kgs per cubic meter.

Plan de travail en aggloméré en ép. 18 mm, revêtu sur deux cotés avec papier mélaminé anti-rayures et antireflet; avec formage tout au long du périmètre avec une épaisseur de 10 mm et verni laqué mat en plusieurs finitions. Les chants droits sont en ABS en 1 mm antichoc sur les 4 cotés assortis au plan; les côtés ont un profil extrudé en alu ép. 5 mm x h.10 mm brillant lucide.

Aus 18 mm starkem Holzkonglomerat, mit Melaminpapier überzogen, mit 4 Seiten H. 10 mm aus ABS 1 mm stark, matt lackiert in verschiedenen Farben.
Plattendichte: 670/730 kg/m³

Finishes

Finitions

Ausführungen

LB 	LL 	LS 	NK 	LE 	LT 	NU 	NJ 
White Blanc Weiss	Grey White Blanc Gris Grauweiss	Silk Grey Gris Soie Seidengrau	Light Beige Beige clair Beige Hell	Beige Beige Beige	Beige Grey Gris Beige Beigegrau	Dark Brown Marron foncé Dunkelbraun	Burnt Orange Orange brûlé Verbrannte Orange
NW 	LA 	LH 	LR 	LI 	LZ 	NQ 	LC 
Ocher Jaune moutard Ockergelb	Orange Orange Orange	Flame Red Rouge Feu Feuerrot	Purple Red Rouge Pourpre Purpurrot	Black Red Rouge foncé Schwarz Rot	Sapphire Blue Bleu Saphire Saphirblau	Cobalt Blue Bleu Cobalt Kobaltblau	Pigeon Blue Bleu Pigeon Tauben Blau
LD 	LP 	NV 	LF 	LG 	LO 	LN 	
Ocean Blue Bleu Océan Ozeanblau	Pine Green Vert pin Kieferngrün	Olive Green Vert olive Olivgrün	Telegrey 4 Telegris 4 Telegrau 4	Grey Gris Grau	Umbra Grey Gris Ombre Umbragrau	Traffic Black Noir Signalisation Verkehrsschwarz	

Production lead time: 5 weeks exclusive of delivery time. Apart from the shown finish options any RAL color can be made to order.

Délai de fabrication: 5 semaines; tous les finitions RAL sont disponibles sur requête

Lieferzeit: 5 Wochen; zusätzlich zu den vorgeschlagenen Lackierungen sind alle Ausführungen der RAL-Skala verfügbar

Depending on the surface the color may vary slightly from the reference (RAL / NCS) provided.

En fonction de la surface, la couleur peut varier légèrement par rapport à la référence (RAL / NCS) fournie.

Je nach Oberfläche kann die Farbe in Bezug auf die RAL/NCS Referenz abweichen.

Specification sheet

Caractéristiques techniques

Technische Beschreibungen

GLASS TOPS / PLATEAUX EN VERRE / TISCHPLATTEN AUS GLAS

10mm fingerprint-proof back painted tempered glass with a satin white finish. Top fitted on stainless steel spacers. 45° smooth polished edges and radiused corners.

Réalisés en verre trempé extra clair, épaisseur 10 mm, satinés dans la partie supérieure et vernis dans la partie inférieure; équipés aussi de plaques de fixations en acier inox. Ils ont des angles avec chant fil lucide plat et coins arrondis à 45°.

Aus extra klarem, gehärtetem Glas, 10 mm stark, auf der Oberseite satiniert und auf der Unterseite lackiert und mit Befestigungsplatten aus Edelstahl versehen. Abgerundete Ecken, mit einer glänzenden flachen Kante und 45° abgeschrägten Kanten.

Finishes
Finitions
Ausführungen

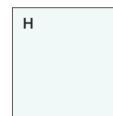

Matt white
Blanc mat
Weiss matt

PORCELAIN TOPS / PLATEAUX EN GRÈS DE PORCELAINE / PLATTEN AUS FEINSTEINZEUG

18mm melamine faced chipboard (MFC) top bonded to a 3 or 5mm PORCELAIN top with 1.5mm 45° beveled flat edges; the top is either 5mm or 3mm thick depending on the finish.

Réalisés par encollage dans le couplage d'un plateau inférieur en mélaminé ép. 18 mm avec une plaque supérieure en GRES ép. 3 ou 5 mm selon la finition, avec chants à fil plat et arrondis 1,5 mm x 45°.

Hergestellt durch Aufkleben einer 18 mm starkem Holzkonglomerat, mit Melaminpapier überzogen, mit einer je nach Ausführung 3 oder 5 mm dicken Deckplatte aus Feinsteinzeug mit flachen, bündigen Kanten und 1,5 mm x 45° abgeschrägten Kanten.

Finishes
Finitions
Ausführungen

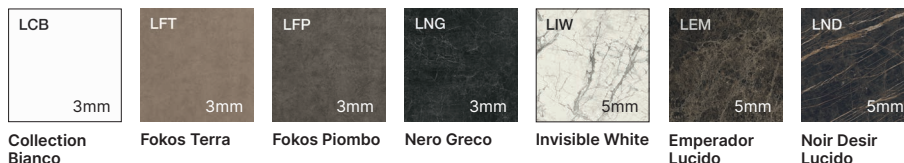

METAL FRAME / STRUCTURE MÉTALLIQUE / METALGESTELLE

Legs and perimeter frame made from steel tubes linked together by die-cast zamak three-arm corner units. All parts supplied epoxy powder coated.

Pieds et cadre tout autour en tôle d'acier verni à poudre époxy, liés entre eux par des jonctions à angle en moulage sous pression de ZaMa, verni à poudre époxy.

FüÙe und Rahmengestell aus epoxidpulverbeschichteten Stahlblechprofilen, mit Epoxidpulverlack beschichtet.

Finishes
Finitions
Ausführungen

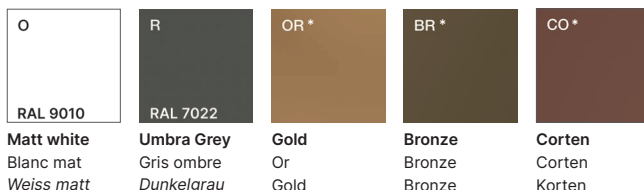

* Production lead time: 5 weeks exclusive of delivery time
Délai de fabrication: 5 semaines
Lieferzeit: 5 Wochen

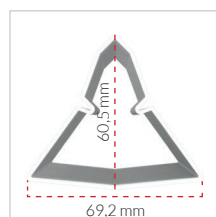

Legs made from 2mm triangle-shaped steel tube, 60.5x69.2mm section.

Pied en profilé de tôle d'acier ép. 2 mm, à section 60,5x69,2 mm.

Fuß aus gebeiztem Stahlblechprofil. 60,5x69,2 mm, Stärke 2 mm.

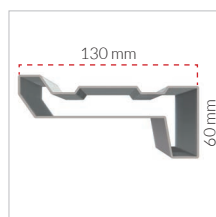

Perimeter frame made from 1.5mm steel tube, 130x60mm section.

Cadre tout autour en profilé de tôle d'acier ép. 1,5 mm, à section 130x60 mm.

Rahmengestell aus 1,5 mm starkem Stahlblechprofil, Querschnitt 130x60 mm.

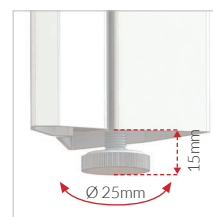

0-15mm adjustable levelling feet made of polyethylene, 25mm diameter.

Vérins de réglage en polyéthylène, Ø25 mm, avec réglage 0-15 mm.

Polyethylen-Nivellierfuß, Farbe grau, Ø 25mm, mit Verstellung 0-15 mm.

Depending on the surface the color may vary slightly from the reference (RAL / NCS) provided.

En fonction de la surface, la couleur peut varier légèrement par rapport à la référence (RAL / NCS) fournie.

Je nach Oberfläche kann die Farbe in Bezug auf die RAL/NCS Referenz abweichen.

W	D	H	CODE	PTS	OPTIONS (PTS)	CBM	KGS	PARCELS
L	P	H	REF.		OPTIONS (PTS)	MC	KG	COLIS
B	T	H	ART. NR.		VARIANTEN (PTS)	M ³	KG	KOLLI

**Table with melamine top**

Table avec plateau en mélaminé

Tisch mit Platte aus Melamin

					LA	TM			
180	100	75	L08SCL01	2088	+316	+516	0,298	72,4	6
200	100	75	L08SCL02	2134	+352	+520	0,313	77,3	6
220	100	75	L08SCL05	2260	+424	+530	0,330	85,5	6
* 220	110	75	L08SCL03	2260	+424	+530	0,339	89,1	6
* 240	110	75	L08SCL04	2332	+464	+541	0,354	94,9	6

**Table with glass top**

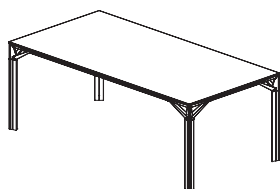
Table avec plateau en verre

Tisch mit Platte aus Glas

					TM				
180	100	75	L08SCV51	2757	+516		0,355	127,4	6
200	100	75	L08SCV52	2844	+520		0,375	144,3	6
220	100	75	L08SCV55	3217	+530		0,647	240,2	6
* 220	110	75	L08SCV53	3217	+530		0,413	167,1	6
* 240	110	75	L08SCV54	3411	+541		0,435	178,9	6

**Table with 3mm stoneware top**

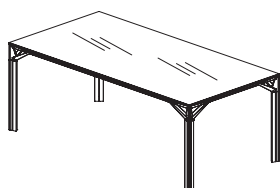
Table avec plateau en grès ép. 3 mm

Tisch mit Platte aus Feinsteinzeug Stärke 3mm

					TM				
180	100	75,3	L08SC301	3042	+516		0,300	85,9	6
200	100	75,3	L08SC302	3176	+520		0,320	92,3	6
220	100	75,3	L08SC305	3393	+530		0,350	105,6	6

**Table with 5mm stoneware top**

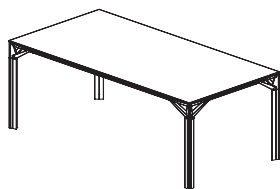
Table avec plateau en grès ép. 5 mm

Tisch mit Platte aus Feinsteinzeug Stärke 5mm

					TM				
180	100	75,5	L08SC501	3572	+516		0,310	94,9	6
200	100	75,5	L08SC502	3740	+520		0,320	102,3	6
220	100	75,5	L08SC505	3989	+530		0,350	116,6	6

LA = Lacquered / Laqué / Lackiert

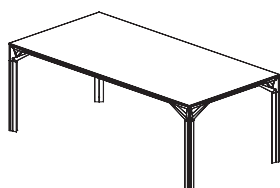
TM = Gold (OR), Bronze (BR) or Corten (CR) frame / Cadre Or (OR), Bronze (BR) ou Corten (CR) / Gestell in Gold (OR), Bronze (BR) oder Kupfer (CO)

* This item will shortly be discontinued / Article plus en reassort / Ausverkauft

SEVEN

designed by Quadrifoglio Group



MELAMINE TOPS / PLATEAUX EN MÉLAMINE / TISCHPLATTEN AUS MELAMIN

18mm easy to clean scratch-resistant anti-reflective melamine faced chipboard (MFC) floating top. 10mm high chamfered edges finished with 1mm impact resistant matching Abs. Both ends feature 10mm high 5mm thick polished aluminium trims recessed into the desk surface.

Panel density: 670/730 kgs per cubic meter.

Plan de travail en aggloméré en ép. 18 mm, revêtu sur deux cotés avec papier mélaminé mat anti-rayures et antireflet; avec formage tout au long du périmètre avec une épaisseur de 10 mm. Les chants droits sont en ABS en 1 mm antichoc sur les 4 cotés assortis au plan; les côtés ont un profil extrudé en alu ép. 5 mm x h.10 mm brillant lucide. Densité panneau: 670/730 kg/m³

Aus 18 mm starkem Holzkonglomerat, ummantelt mit opakem, reflexfreiem und kratzfestem Melaminpapier, haben sie eine Form entlang des Umfangs von h. 10 mm. Die Längsseiten sind mit 1 mm starkem, stoßfestem ABS umrandet, die Oberseite ist mit einem 5 mm x h.10 mm starken, polierten Aluminium-Strangpressprofil versehen. Plattendichte: 670/730 kg/m³

Finishes

Finitions

Ausführungen

White Blanc Weiss	Eucalyptus Eucalyptus Eukalyptus	Elm Orme Ulme	Canaletto Walnut Noyer Canaletto Nuss Canaletto

LACQUERED MELAMINE TOPS / PLATEAUX EN MÉLAMINE LAQUÉ / TISCHPLATTEN AUS MELAMIN, LACKIERT

18mm scratch & abrasion resistant lacquered melamine faced chipboard (MFC) floating top. 10mm high chamfered edges finished with 1mm impact resistant matching Abs. Matt lacquers. Both ends feature 10mm high 5mm thick polished aluminium trims recessed into the desk surface. Panel density: 670/730 kgs per cubic meter.

Plan de travail en aggloméré en ép. 18 mm, revêtu sur deux cotés avec papier mélaminé anti-rayures et antireflet; avec formage tout au long du périmètre avec une épaisseur de 10 mm et verni laqué mat en plusieurs finitions. Les chants droits sont en ABS en 1 mm antichoc sur les 4 cotés assortis au plan; les côtés ont un profil extrudé en alu ép. 5 mm x h.10 mm brillant lucide.

Aus 18 mm starkem Holzkonglomerat, mit Melaminpapier überzogen, h.10 mm entlang des gesamten Umfangs geformt, die Längsseiten mit ABS 1mm stark eingefasst und alle matt lackiert in verschiedenen Farben. Kurze Kopfseiten, die mit einem 5 mm x h.10 mm starken, polierten Aluminium-Strangpressprofil versehen sind. Plattendichte: 670/730 kg/m³

Finishes

Finitions

Ausführungen

White Blanc Weiss	Grey White Blanc Gris Grauweiss	Silk Grey Gris Soie Seidengrau	Light Beige Beige clair Beige Hell	Beige Beige Beige	Beige Grey Gris Beige Beigegrau	Dark Brown Marron foncé Dunkelbraun	Burnt Orange Orange brûlé Verbrannte Orange
Ocher Jaune moutard Ockergelb	Orange Orange Orange	Flame Red Rouge Feu Feuerrot	Purple Red Rouge Pourpre Purpurrot	Black Red Rouge foncé Schwarz Rot	Sapphire Blue Bleu Saphire Saphirblau	Cobalt Blue Bleu Cobalt Kobaltblau	Pigeon Blue Bleu Pigeon Tauben Blau
Ocean Blue Bleu Océan Ozeanblau	Pine Green Vert pin Kieferngrün	Olive Green Vert olive Olivgrün	Telegrey 4 Telegris 4 Telegrau 4	Grey Gris Grau	Umbra Grey Gris Ombre Umbragrau	Traffic Black Noir Signalisation Verkehrsschwarz	

Production lead time: 5 weeks exclusive of delivery time. Apart from the shown finish options any RAL color can be made to order.

Délai de fabrication: 5 semaines; tous les finitions RAL sont disponibles sur requête

Lieferzeit: 5 Wochen; zusätzlich zu den vorgeschlagenen Lackierungen sind alle Ausführungen der RAL-Skala verfügbar

Depending on the surface the color may vary slightly from the reference (RAL / NCS) provided.

En fonction de la surface, la couleur peut varier légèrement par rapport à la référence (RAL / NCS) fournie.

Je nach Oberfläche kann die Farbe in Bezug auf die RAL/NCS Referenz abweichen.

Specification sheet

Caractéristiques techniques

Technische Beschreibungen

GLASS TOPS / PLATEAUX EN VERRE / TISCHPLATTEN AUS GLAS

10mm fingerprint-proof back painted tempered glass with a satin white finish. Floating top supported on stainless steel spacers. 45° smooth polished edges and radiused corners.

Réalisés en verre trempé extra clair, épaisseur 10 mm, satinés dans la partie supérieure et vernis dans la partie inférieure; équipés aussi de plaques de fixations en acier inox. Ils ont des angles avec chant fil lucide plat et coins arrondis à 45°.

Aus extra klarem, gehärtetem Glas, 10 mm stark, auf der Oberseite satiniert und auf der Unterseite lackiert und mit Befestigungsplatten aus Edelstahl versehen. Sie haben abgerundete Ecken, mit einer glänzenden flachen Kante und 45° abgeschrägten Kanten.

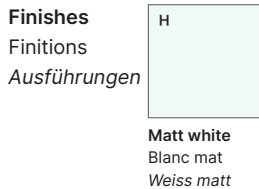

PORCELAIN TOPS / PLATEAUX EN GRÈS DE PORCELAINE / PLATTEN AUS FEINSTEINZEUG

18mm melamine faced chipboard (MFC) top bonded to a 3 or 5mm PORCELAIN top with 1.5mm 45° beveled flat edges; the top is either 5mm or 3mm thick depending on the finish.

Réalisés par encollage dans le couplage d'un plateau inférieur en mélaminé ép. 18 mm avec une plaque supérieure en GRES ép. 3 ou 5 mm selon la finition, avec chants à fil plat et arrondis 1,5 mm x 45°.

Hergestellt durch Aufkleben einer 18 mm starkem Holzkonglomerat, mit Melaminpapier überzogen, mit einer je nach Ausführung 3 oder 5 mm dicken Deckplatte aus Feinsteinzeug mit flachen, bündigen Kanten und 1,5 mm x 45° abgeschrägten Kanten.

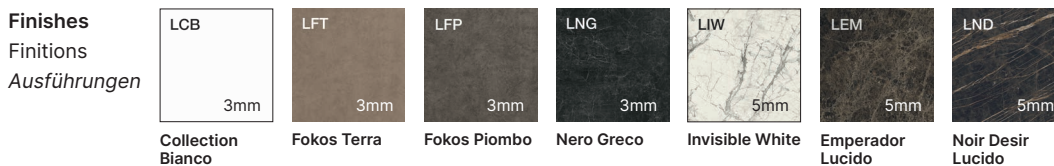

METAL FRAME / STRUCTURE MÉTALLIQUE / METALGESTELLE

Goalpost and Loop leg frame. Manufactured from epoxy powder coated or chromed steel.

Pieds fermé "Closed" et ouvert "Open" en profilé de tôle d'acier vernis à poudre époxy ou chromé brillant.

Gestell Closed und Open aus epoxidpulverbeschichtetem oder poliertem verchromtem Stahlblechprofil.

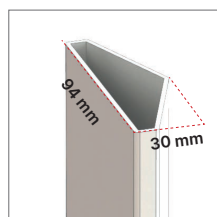
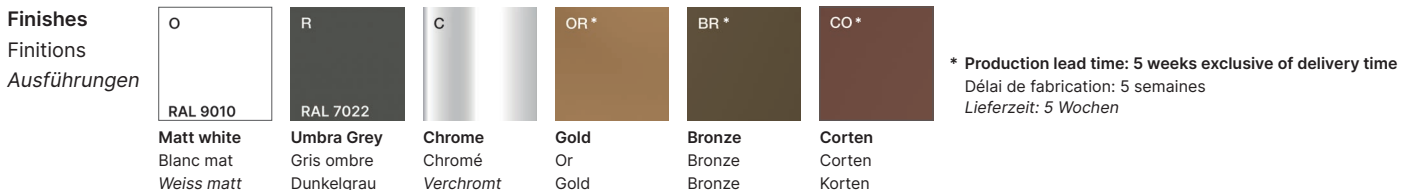

Legs made from 94×30mm pentagon-shaped 2mm steel tube.

Pied profilé en tôle d'acier épaisseur 2 mm, à section pentagonal 94×30 mm.
Fuß aus 2 mm starkem Stahlblechprofil, Fünfkantprofil 94×30 mm.

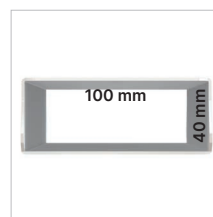

Beams made from 100×40mm rectangular 1.5mm steel tube, in silver finish.

Longerons en acier à section rectangulaire 100×40 mm, ép. 1,5 mm, en finition aluminium.

Stahltraversen mit rechteckigem Querschnitt 100×40 mm, 1,5 mm stark, in silberfarbener Ausführung.

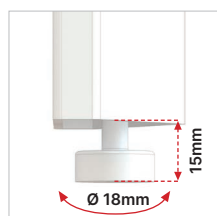

Goalpost leg frame: 0-15mm adjustable levelling feet made of polyethylene, 18mm diameter.

Pied Open: vérin de réglage en polyéthylène, Ø18 mm, avec réglage 0-15 mm.

Fuß OPEN: Polyethylen-Nivellierfuß, Ø18 mm, mit Verstellung 0-15 mm.

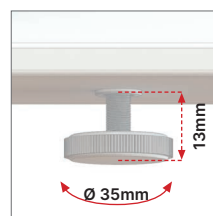

Loop leg frame: 0-13mm adjustable levelling feet made of polyethylene, 35mm diameter.

Pied Closed: vérin de réglage en polyéthylène, Ø35 mm, avec réglage 0-13 mm.

Gestell Closed: Polyethylen-Nivellierfuß, Ø35 mm, mit Verstellung 0-13 mm.

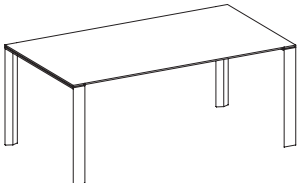
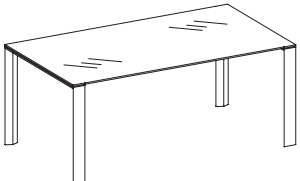
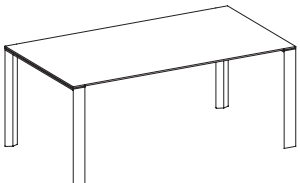
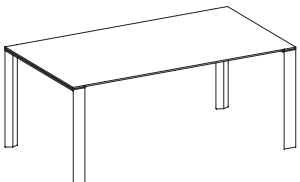
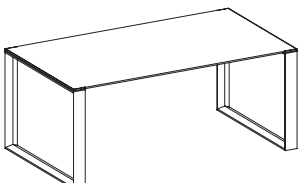
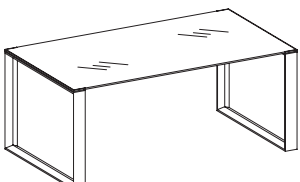
	W	D	H	CODE	PTS	OPTIONS (PTS)	CBM	KGS	PARCELS		
	L	P	H	REF.	PTS	OPTIONS (PTS)	MC	KG	COLIS		
	B	T	H	ART. NR.		VARIANTEN (PTS)	M ³	KG	KOLLI		
	Table with melamine top										
	Table avec plateau en mélaminé										
	Tisch mit Platte aus Melamin										
							C	LA	TM		
	180	100	74,8	L07SCL01	1879	+616	+316	+162	0,318	60,5	4
	200	100	74,8	L07SCL04	1905	+616	+352	+162	0,332	65,0	4
	220	100	74,8	L07SCL07	1933	+616	+388	+162	0,346	69,5	4
	Table with glass top										
	Table avec plateau en verre										
	Tisch mit Platte aus Glas										
							C	TM			
	180	100	75,5	L07SCV11	2360	+616	+162		0,370	115,5	4
	200	100	75,5	L07SCV14	2485	+616	+162		0,384	132,0	4
	220	100	75,5	L07SCV17	2612	+616	+162		0,398	148,5	4
	Table with 3mm stoneware top										
	Table avec plateau en grès ép. 3 mm										
	Tisch mit Platte aus Feinsteinzeug Stärke 3mm										
							C	TM			
	180	100	75,0	L07SC301	2695	+616	+162		0,320	74,0	4
	200	100	75,0	L07SC304	2810	+616	+162		0,340	80,0	4
	220	100	75,0	L07SC307	2929	+616	+162		0,350	86,0	4
	Table with 5mm stoneware top										
	Table avec plateau en grès ép. 5 mm										
	Tisch mit Platte aus Feinsteinzeug Stärke 5mm										
							C	TM			
	180	100	75,3	L07SC501	3226	+616	+162		0,330	83,0	4
	200	100	75,3	L07SC504	3374	+616	+162		0,340	90,0	4
	220	100	75,3	L07SC507	3525	+616	+162		0,360	97,0	4
	Table with melamine top										
	Table avec plateau en mélaminé										
	Tisch mit Platte aus Melamin										
							C	LA	TM		
	180	100	74,8	L07SCL41	1996	+757	+316	+152	0,318	69,5	4
	200	100	74,8	L07SCL61	2021	+757	+352	+152	0,332	74,0	4
	220	100	74,8	L07SCL81	2047	+757	+388	+152	0,364	78,5	4
	Table with glass top										
	Table avec plateau en verre										
	Tisch mit Platte aus Glas										
							C	TM			
	180	100	75,5	L07SCV51	2473	+757	+152		0,370	124,5	4
	200	100	75,5	L07SCV71	2599	+757	+152		0,384	141,0	4
	220	100	75,5	L07SCV91	2724	+757	+152		0,398	157,5	4

LA = Lacquered / Laqué / Lackiert

C = Chrome frame / Structure en chrome / Gestell verchromt

TM = Gold (OR), Bronze (BR) or Corten (CR) frame / Cadre Or (OR), Bronze (BR) ou Corten (CR) / Gestell in Gold (OR), Bronze (BR) oder Kupfer (CO)

Seven tables - Loop frame

Tables Seven - pied Closed

Tische Seven - Kufengestell

W	D	H	CODE		OPTIONS (PTS)	CBM	KGS	PARCELS
L	P	H	REF.	PTS	OPTIONS (PTS)	MC	KG	COLIS
B	T	H	ART. NR.		VARIANTEN (PTS)	M ³	KG	KOLLI

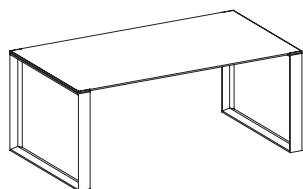

Table with 3mm stoneware top

Table avec plateau en grès ép. 3 mm

Tisch mit Platte aus Feinsteinzeug Stärke 3mm

					C	TM			
180	100	75,0	L07SC341	2811	+757	+152	0,320	83,0	4
200	100	75,0	L07SC361	2926	+757	+152	0,340	89,0	4
220	100	75,0	L07SC381	3043	+757	+152	0,370	95,0	4

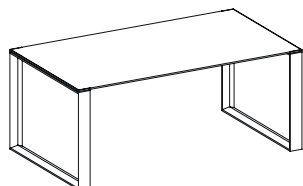

Table with 5mm stoneware top

Table avec plateau en grès ép. 5 mm

Tisch mit Platte aus Feinsteinzeug Stärke 5mm

					C	TM			
180	100	75,3	L07SC541	3342	+757	+152	0,330	92,0	4
200	100	75,3	L07SC561	3490	+757	+152	0,340	99,0	4
220	100	75,3	L07SC581	3638	+757	+152	0,380	106,0	4

C = Chrome frame / Structure en chrome / Gestell verchromt

TM = Gold (OR), Bronze (BR) or Corten (CR) frame / Cadre Or (OR), Bronze (BR) ou Corten (CR) / Gestell in Gold (OR), Bronze (BR) oder Kupfer (CO)

SIX

designed by Quadrifoglio Group



METAL STRUCTURE / STRUCTURE EN MÉTAL / METALGESTELLE

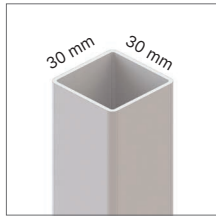

Legs made from 30x30mm 1.5mm steel tube.
Pied en tube à section carré 30x30 mm en épaisseur 1,5 mm.
Fuß aus gebeiztem Rohr mit Vierkantquerschnitt 30x30 mm, 1,5 mm stark.

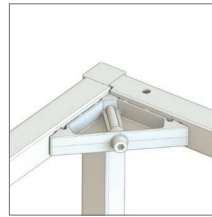

Perimeter frame made from 30x30mm 2mm steel tube.
Zama joint, single screw fastening.
Traverses et longerons à section rectangulaire 30x30 mm, ép. 2 mm. Joint en Zama, fixation par une seule vis.
Traversen und Längsträger mit Rechteckquerschnitt 30x30 mm, Stärke 2 mm. Zama-Verbindung, mit einer einzigen Schraube befestigt.

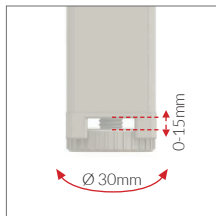

Ø30mm grey polyethylene 0-15mm adjustable levelling feet
Vérin de réglage en polyéthylène, finition grise, Ø 30mm, réglage 0-15 mm.
Nivellierfuß aus Polyethylen, Farbe grau, Ø 30mm, mit Verstellung 0-15 mm.

Finishes
Finitions
Ausführungen

O	R	OR*	BR*	CO*
RAL 9010	RAL 7022			
White Blanc Weiss	Shadow grey Gris ombre Dunkelgrau	Gold Or Gold	Bronze Bronze Bronze	Corten Corten Korten

* Production lead time: 5 weeks exclusive of delivery time
Délai de fabrication: 5 semaines
Lieferzeit: 5 Wochen

METAL TOP / PLATEAU EN MÉTAL / METALLPLATTE

Top made of folded pickled metal sheet 1.2 mm thick and painted with epoxy powders
Plateau réalisé en tôle décapé ép. 1,2 mm et verni par poudre époxy.
Platte aus einem gebeizten und gebogenen Stahlblech, St. 1,2mm, mit Epoxidpulvern beschichtet.

Finishes
Finitions
Ausführungen

O	R	OR*	BR*	CO*
RAL 9010	RAL 7022			
White Blanc Weiss	Shadow grey Gris ombre Dunkelgrau	Gold Or Gold	Bronze Bronze Bronze	Corten Corten Korten

* Production lead time: 5 weeks exclusive of delivery time
Délai de fabrication: 5 semaines
Lieferzeit: 5 Wochen

PORCELAIN TOPS / PLATEAU EN GRÈS PORCELAINE / PLATTE AUS FEINSTEINZEUG

3 or 5 mm thick GRES slab, depending on the finish, with flat flush edges and 1.5 mm x 45° bevel glued to the metal top.
Plan en grès ép. 3 ou 5 mm selon la finition, avec chant à fil plat et coins arrondis 1,5 mm x 45° couplé en collant un plateau en métal.
Steinplatte St. 3 oder 5mm je nach Dekor, mit flachen Kanten und mit 1,5mm x 45° Anfasung. An der Metallplatte geklebt.

Finishes
Finitions
Ausführungen

LCB	LFT	LFP	LNG	LIW	LEM	LND
3mm	3mm	3mm	3mm	5mm	5mm	5mm
Collection Bianco	Fokos Terra	Fokos Piombo	Nero Greco	Invisible White	Emperador Lucido	Noir Desir Lucido

Depending on the surface the color may vary slightly from the reference (RAL / NCS) provided.
En fonction de la surface, la couleur peut varier légèrement par rapport à la référence (RAL / NCS) fournie.
Je nach Oberfläche kann die Farbe in Bezug auf die RAL/NCS Referenz abweichen.

Six tables

Tables Six

Tische Six

W	D	H	CODE	PTS	OPTIONS (PTS)	CBM	KGS	PARCELS
L	P	H	REF.	PTS	OPTIONS (PTS)	MC	KG	COLIS
B	T	H	ART. NR.		VARIANTEN (PTS)	M ³	KG	KOLLI

**Table with metal top**

Table avec plateau en métal

Tisch mit Platte aus Metall

					TM			
180	100	76,4	L06L1018	1270	+360	0,120	45,8	5
200	100	76,4	L06L1020	1354	+382	0,130	48,9	5
220	100	76,4	L06L1022	1473	+398	0,150	53,4	5
240	100	76,4	L06L1024	1557	+413	0,160	56,6	5
260	100	76,4	L06L1026	1641	+435	0,170	59,7	5

**Table with 3mm stoneware top**

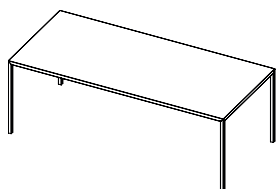
Table avec plateau en grès ép. 3 mm

Tisch mit Platte aus Feinsteinzeug Stärke 3mm

					TM			
180	100	76,7	L0631018	2195	+254	0,130	59,3	5
200	100	76,7	L0631020	2369	+265	0,140	63,9	5
220	100	76,7	L0631022	2579	+276	0,160	69,9	5
240	100	76,7	L0631024	2753	+286	0,170	74,6	5
260	100	76,7	L0631026	2927	+297	0,180	79,2	5

**Table with 5mm stoneware top**

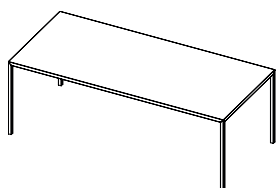
Table avec plateau en grès ép. 5 mm

Tisch mit Platte aus Feinsteinzeug Stärke 5mm

					TM			
180	100	76,9	L0651018	2710	+254	0,130	68,3	5
200	100	76,9	L0651020	2913	+265	0,140	73,9	5
220	100	76,9	L0651022	3151	+276	0,160	80,9	5
240	100	76,9	L0651024	3354	+286	0,170	86,6	5
260	100	76,9	L0651026	3556	+297	0,180	92,2	5

FIVE

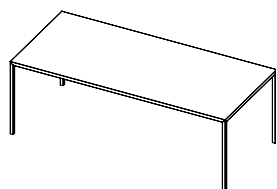
designed by Quadrifoglio Group



TOPS / PLATEAUX / TISCHPLATTE

25mm easy to clean scratch-resistant anti-reflective melamine faced chipboard (MFC) finished with 2mm matching straight ABS impact resistant edges. Panel density: 670/730 kgs per cubic meter.

Plan de travail en aggloméré en ép. 25 mm, revêtu sur deux cotés avec papier décoratif impregné de résine anti-rayures, antireflet et lavable; chants droits en ABS en 2 mm antichoc sur les 4 cotés assortis au plan. Densité panneau: 670/730 kg/m3

Tischplatte aus 25 mm starkem Holzkonglomerat, beidseitig mit reflexfreiem, kratzfestem und waschbarem Melaminbelegt. 4-seitige Kante aus schlagfestem ABS, 2 mm stark. Dichte der Platte: 670/730 kg/m3

Finishes

Finitions

Ausführungen

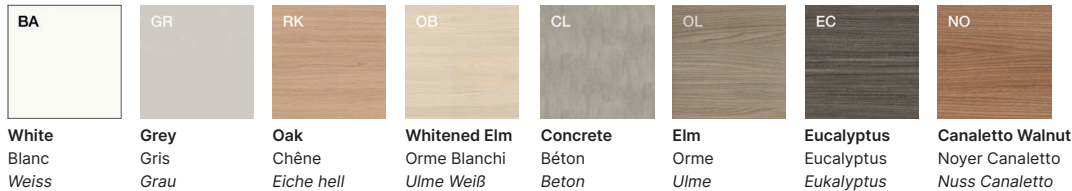

METAL FRAME / STRUCTURE MÉTALLIQUE / METALGESTELL

Epoxy powder coated steel frame.

Structure en tôle d'acier verni avec poudre époxy.

Gestell aus epoxidpulverbeschichtetem Stahlblechprofil.

Finishes

Finitions

Ausführungen



* Production lead time: 5 weeks exclusive of delivery time

Délai de fabrication: 5 semaines

Lieferzeit: 5 Wochen

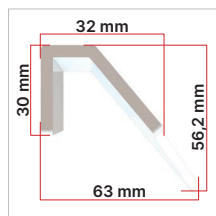

Tapered legs made of 4mm steel open sections, cross section tapers from 30×32mm (lower end) to 63FIVE6.2mm (upper end)

Pied en tube d'acier, section initial 30 × 32 mm (finale 63 × 56,2 mm), en ép. 4 mm.

Fuß aus gebeiztem Stahlblechprofil 4 mm stark. Anfangsschnitt 30×32mm (Endschnitt 63FIVE6,2mm).

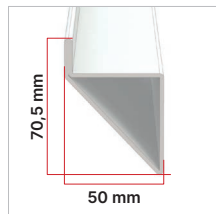

Crossbar between legs made of 50×70.5mm 2mm steel hollow tube, beams are fitted using steel brackets welded to crossbar

Traverse pied en tube profilé, section 50×70,5 mm, ép. 2 mm avec soudé des greffons pour fixations des poutres.

Querträger aus gebeiztem Profilrohr, Querschnitt 50×70,5 mm, Stärke 2 mm, mit angeschweißten verdeckten Kupplungen zum Einsetzen von Trägern.

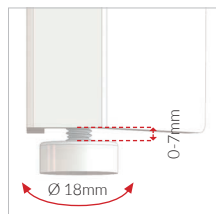

0-7mm adjustable levelling feet made of grey polyethylene, 18mm diameter

Vérins de réglage en polyéthylène, couleur gris, Ø 18mm, réglage 0-7 mm.

Nivellierfuß aus Polyethylen, Farbe grau, Ø 18mm, mit Verstellung 0-7 mm.

Depending on the surface the color may vary slightly from the reference (RAL / NCS) provided.
En fonction de la surface, la couleur peut varier légèrement par rapport à la référence (RAL / NCS) fournie.
Je nach Oberfläche kann die Farbe in Bezug auf die RAL/NCS Referenz abweichen.

Five tables
Tables Five
Tische Five

W	D	H	CODE	PTS	OPTIONS (PTS)	CBM	KGS	PARCELS
L	P	H	REF.	PTS	OPTIONS (PTS)	MC	KG	COLIS
B	T	H	ART. NR.		VARIANTEN (PTS)	M ³	KG	KOLLI

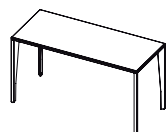

Table with melamine top, top D. 60 cm
 Table avec plateau en mélaminé en P. 60 cm
 Tisch mit Platte aus Melamin, Platte T 60 cm

					TM			
80	60	75	L05L0208	944	+142	0,230	32,0	5
100	60	75	L05L0210	976	+153	0,240	35,5	5
120	60	75	L05L0212	1005	+153	0,240	39,5	5
140	60	75	L05L0214	1034	+153	0,250	43,0	5
160	60	75	L05L0216	1062	+158	0,260	47,0	5
180	60	75	L05L0218	1091	+158	0,260	50,5	5

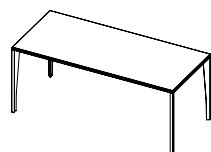

Table with melamine top, top D. 80 cm
 Table avec plateau en mélaminé en P. 80 cm
 Tisch mit Platte aus Melamin, Platte T 80 cm

					TM			
80	80	75	L05L0108	1022	+164	0,240	36,0	5
100	80	75	L05L0110	1055	+175	0,240	40,0	5
120	80	75	L05L0112	1085	+175	0,250	44,0	5
140	80	75	L05L0114	1118	+175	0,260	48,5	5
160	80	75	L05L0116	1149	+180	0,270	53,0	5
180	80	75	L05L0118	1181	+180	0,270	57,5	5

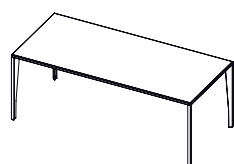

Table with melamine top, top D. 90 cm
 Table avec plateau en mélaminé en P. 90 cm
 Tisch mit Platte aus Melamin, Platte T 90 cm

					TM			
180	90	75	L05L0119	1229	+202	0,330	62,5	5
200	90	75	L05L0120	1262	+208	0,330	68,0	5

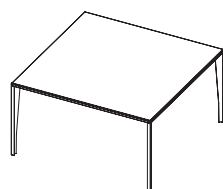

Table with melamine top
 Table avec plateau en mélaminé
 Tisch mit Platte aus Melamin

					TM			
120	120	75	L05LT112	1212	+218	0,420	57,5	5
160	120	75	L05LT116	1257	+224	0,430	70,0	5

THREE

designed by Quadrifoglio Group



WORKTOPS / PLATEAUX / SCHREIBTISCHPLATTE

25 mm melamine faced chipboard finished with 2mm matching straight ABS impact resistant edges, easy to clean scratch-resistant anti-reflective melamine. Panel density: 670/730 kgs per cubic meter.



Plan de travail en aggloméré en ép. 25 mm, revêtu sur deux cotés avec papier décoratif impregné de résine anti-rayures, antireflet et lavable; chants droits en ABS en 2 mm antichoc sur les 4 cotés assortis au plan. Densité panneau: 670/730 kg/m3.

Tischplatte aus 25 mm starkem Holzkonglomerat, beidseitig mit reflexfreiem, kratzfestem und waschbarem Melamin belegt. 4-seitige Kante aus schlagfestem ABS, 2 mm stark. Dichte der Platte: 670/730 kg/m3.

Finishes

Finitions

Ausführungen

						
BA	GR	CL	OL	OB	RK	NO
White Blanc Weiss	Grey Gris Grau	Concrete Béton Beton	Elm Orme Ulme	Whitened Elm Orme Bianchi Ulme Weiß	Oak Chêne Eiche hell	Canaletto Walnut Noyer Canaletto Nuss Canaletto

METAL FRAME / STRUCTURE EN MÉTAL / METALGESTELLE

Epoxy powder coated steel frame.

Pieds et poutre en tôle d'acier verni avec poudre époxy.

Füße und Traversen aus epoxidpulverbeschichtetem Stahlblech.

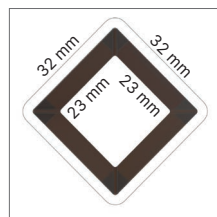

Tapered legs made of 2mm steel tube, cross section tapers from 23×23mm (lower end) to 32×32mm (upper end).

Pied en tube d'acier à section conique rhomboïdal, section initial 32 × 32 mm (finale 23 × 23 mm), en ép. 2 mm.

Fuß Profilrohr mit rhombisch konischem Querschnitt, Anfangsquerschnitt 32×32 mm (Endquerschnitt 23×23 mm), 2 mm stark.

Finishes

Finitions

Ausführungen

				
I	R	OR*	BR*	CO*
RAL 9016 White Blanc Weiss	RAL 7022 Shadow grey Gris ombre Dunkelgrau	Gold Or Gold	Bronze Bronze Bronze	Corten Corten Korten

* Production lead time: 5 weeks exclusive of delivery time
Délai de fabrication: 5 semaines
Lieferzeit: 5 Wochen

Beams are always supplied in silver.
Poutre toujours en finition alu.
Traverse in silberfarbener Ausführung.

Specification sheet

Caractéristiques techniques

Technische Beschreibungen

METAL FRAME ON WOODEN LEGS / STRUCTURE BOIS ET MÉTAL / METALLRAHMEN MIT HOLZFUSS

Epoxy powder coated steel end and under top beams. Metal frame on wooden legs:

- upper section made from epoxy powder coated steel tube;
- lower section made from dried ash solid wood varnished in a light oak finish.

Traverses et longerons en acier tubulaire vernis à poudres époxy. Pieds mixtes bois et métal:

- partie supérieure en tubes d'acier vernis à poudres époxy;
- partie inférieure en bois de frêne séché et vernis effet chêne.

Traversen aus epoxipulverbeschichtetem Stahlblechprofil. Metallrahmen mit Holzfuß:

- Metallrahmen aus epoxipulverbeschichtetem Stahlblechprofil;
- Holzfuß aus gedörrtem Eschenholz, Eiche lackiert.

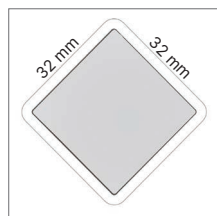

Frame made from 2mm steel tube, cross section 32×32mm.

Partie supérieure du pied en tube profilé découpé à section rhomboïdale 32×32 mm, épaisseur 2 mm.

Metallrahmen mit gebeiztem Profil, rautenförmiger Querschnitt 32×32mm, 2mm stark.

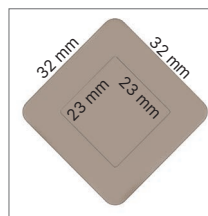

Legs lower section made from dried ash solid wood, cross section tapers from 23×23 mm (lower end) to 32×32 mm (upper end).

Partie inférieure du pied en bois de frêne séché à section conique rhomboïdale (section initiale 32×32 mm, finale 23×23 mm).

Holzfuß aus gedörrtem Eschenholz, konisch rautenförmiger Querschnitt (Anfang 32×32mm, Ende 23×23mm).

Finishes

Finitions

Ausführungen

I	R	OR*	BR*	CO*
RAL 9016	RAL 7022			
White	Shadow grey	Gold	Bronze	Corten
Blanc	Gris ombre	Or	Bronze	Corten
Weiss	Dunkelgrau	Gold	Bronze	Korten

Finishes

Finitions

Ausführungen

W
Oak
Chêne
Eiche hell

* Production lead time: 5 weeks exclusive of delivery time

Délai de fabrication: 5 semaines

Lieferzeit: 5 Wochen

Depending on the surface the color may vary slightly from the reference (RAL / NCS) provided.
En fonction de la surface, la couleur peut varier légèrement par rapport à la référence (RAL / NCS) fournie.
Je nach Oberfläche kann die Farbe in Bezug auf die RAL/NCS Referenz abweichen.

W	D	H	CODE	PTS	OPTIONS (PTS)	CBM	KGS	PARCELS
L	P	H	REF.		OPTIONS (PTS)	MC	KG	COLIS
B	T	H	ART. NR.		VARIANTEN (PTS)	M ³	KG	KOLLI

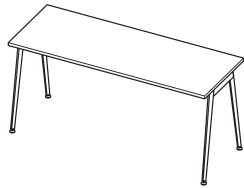

Table with melamine top, top D. 60 cm
Table avec plateau en mélaminé en P. 60 cm
Tisch mit Platte aus Melamin, Platte T 60 cm

						W	TM			
80	60	75	L03L0208	444		+365	+120	0,129	20,0	4
100	60	75	L03L0210	459		+365	+120	0,133	22,85	4
120	60	75	L03L0212	471		+365	+120	0,140	25,8	4
140	60	75	L03L0214	483		+365	+120	0,144	28,1	4
160	60	75	L03L0216	498		+365	+120	0,149	30,9	4
180	60	75	L03L0218	511		+365	+120	0,155	33,3	4

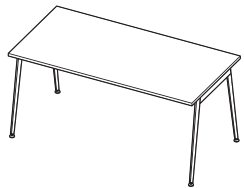

Table with melamine top, top D. 80 cm
Table avec plateau en mélaminé en P. 80 cm
Tisch mit Platte aus Melamin, Platte T 80 cm

						W	TM			
80	80	75	L03L0108	460		+365	+131	0,107	22,9	3
100	80	75	L03L0110	475		+365	+131	0,112	26,25	3
120	80	75	L03L0112	490		+365	+131	0,120	29,2	3
140	80	75	L03L0114	508		+365	+131	0,125	32,5	3
160	80	75	L03L0116	523		+365	+131	0,131	35,8	3
180	80	75	L03L0118	540		+365	+131	0,139	39,2	3

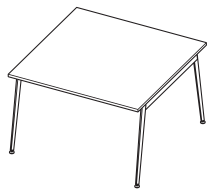

Table with melamine top
Table avec plateau en mélaminé
Tisch mit Platte aus Melamin

						W	TM			
120	120	75	L03LT112	588		+365	+175	0,266	45,2	5
160	120	75	L03LT116	613		+365	+175	0,283	55,9	5

TWO

designed by Quadrifoglio Group



MFC TOPS / PLATEAUX EN MÉLAMINE / MELAMINPLATTEN

30mm easy to clean scratch-resistant anti-reflective melamine faced chipboard (MFC) top finished with 2mm matching straight ABS impact resistant edges. Panel density: 670/730 kgs per cubic meter.







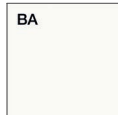

Plateaux en aggloméré ép. 30 mm, revêtu sur deux cotés avec papier de mélamine anti-rayures et antireflet; chants droits en ABS ép. 2 mm antichoc sur les 4 cotés assortis au plan. Densité panneau: 670/730 kg/m³

Platten aus 30 mm starkem Holzkonglomerat, beidseitig mit reflexfreiem, kratzfestem und waschbarem Melaminpapier überzogen. 2 mm starke, stoßfeste ABS-Kante in gleicher Farbe. Dichte der Platte: 670/730 kg/m³

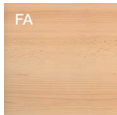
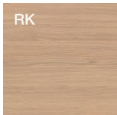
Finishes

Finitions

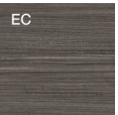
Ausführungen

BA 	GR 	FA 	RK 	CL 	OB 	OL 	EC 	NO 
White Blanc Weiss	Grey Gris Grau	Beech Hêtre Buche	Oak Chêne Eiche hell	Concrete Béton Beton	Whitened Elm Orme Blanchi Ulme Weiß	Elm Orme Ulme	Eucalyptus Eucalyptus Eukalyptus	Canaletto Walnut Noyer Canaletto Nuss Canaletto

METAL STRUCTURE / STRUCTURE EN MÉTAL / METALGESTELLE

40x40mm legs and crossbar made from trapezoidal 1.5mm steel tube, zamak feet. Metal plates screw to the top. All metal parts supplied epoxy powder coated.

Montants verticaux en profil d'acier ép. 1,5 mm, section 40x40, greffés sur pieds en fusion de ZaMa. Plaque d'acier pour la fixation au plateau dans la partie supérieure. Les pieds sont liés entra eux par un longeron en profil d'acier ép. 1,5 mm section 40 x 40. Tout est verni à poudre époxy.

Vertikale Standrohre aus 1,5 mm starkem Stahlprofil 40x40, montiert an den Füßen aus Zynklegierungsguss. Stahlplatten zur Befestigung an dem im oberen Teil befestigten Tisch. Die Füße sind durch eine 1,5 mm starke Stahlprofilstange 40x40 miteinander verbunden. Alle Epoxy-Pulverbeschichtungen.

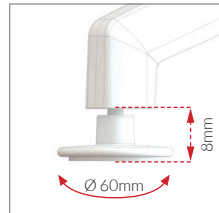

ø60mm chrome Abs 0-8mm adjustable levelling feet.

Vérins de réglage en ABS effet chromé, diam. 60 mm, réglage de 0 à 8 mm.

Nivellierfüße aus verchromtem metallischem ABS, Durchmesser 60mm, verstellbar von 0 bis 8mm

Finishes

Finitions

Ausführungen

I 	A 	R 	OR* 	BR* 	CO* 
White Blanc Weiss	Silver Aluminium Silber	Shadow grey Gris ombre Dunkelgrau	Gold Or Gold	Bronze Bronze Bronze	Corten Corten Korten

* Production lead time: 5 weeks exclusive of delivery time
Délai de fabrication: 5 semaines
Lieferzeit: 5 Wochen

Depending on the surface the color may vary slightly from the reference (RAL / NCS) provided.
En fonction de la surface, la couleur peut varier légèrement par rapport à la référence (RAL / NCS) fournie.
Je nach Oberfläche kann die Farbe in Bezug auf die RAL/NCS Referenz abweichen.

Two tables

Tables Two

Tische Two

W	D	H	CODE	PTS	OPTIONS (PTS)	CBM	KGS	PARCELS
L	P	H	REF.		OPTIONS (PTS)	MC	KG	COLIS
B	T	H	ART. NR.		VARIANTEN (PTS)	M ³	KG	KOLLI

**Table with oval melamine top**

Table avec plateau mélaminé ovale

Tisch mit Platte aus melamin oval

					TM			
200	110	72	L02ITO20	788	+300	0,246	74,0	4
240	110	72	L02ITO24	852	+305	0,246	79,0	4

**Table with rectangular melamine top**

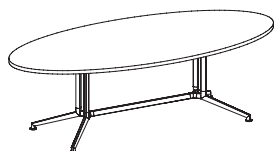
Table avec plateau mélaminé rectangulaire

Tisch mit Platte aus melamin rechteckig

					TM			
210	100	72	L02ITR21	678	+305	0,120	73,3	4

CREO & GREKO

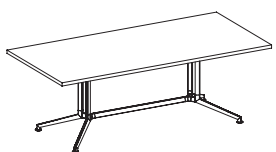
designed by Quadrifoglio Group



WORKTOPS / PLATEAUX / SCHREIBTISCHPLATTE

30 mm melamine faced chipboard (MFC) finished with 2 mm matching straight ABS impact resistant edges, easy to clean scratch-resistant anti-reflective melamine. MFC density 670/730 kgs per cubic meter.

Plans de travail aggloméré en ép. 30 mm, revêtu sur deux cotés avec papier de mélamine anti-rayures et antireflet; chants droits en ABS ép. 2 mm antichoc sur les 4 cotés assortis au plan. Densité panneau: 670/730 kg/m³

Tischplatte aus 30 mm starkem Holzkonglomerat, beidseitig mit reflexfreiem, kratzfestem und waschbarem Melaminbelegt. 4-seitige Kante aus schlagfestem ABS, 2 mm stark. Dichte der Platte: 670/730 kg/m³

Finishes

Finitions
Ausführungen

White Blanc Weiss	Grey Gris Grau	Oak Chêne Eiche hell	Concrete Béton Beton	Whitened Elm Orme Blanchi Ulme Weiß	Elm Orme Ulme	Canaletto Walnut Noyer Canaletto Nuss Canaletto

METAL FRAME / STRUCTURE EN MÉTAL / METALGESTELLE



CREO



GREKO

Frames made of epoxy powder coated steel tube and sheet metal. Modesty panel made of 1mm epoxy powder coated perforated steel.

Pieds et poutre en tube et tôle d'acier verni avec poudre époxy. Voile de fond en tôle d'acier profilé en ép. 1 mm, avec perforations carrées, verni avec poudre époxy.

Füße und Traverse aus epoxidpulverbeschichtetem Stahlblech. Sichtschutzblende aus 1 mm Stahlblech, mit quadratischer ZierPolyethylenforation, mit Epoxidpulver lackiert.

Finishes

Finitions
Ausführungen

RAL 9016 White Blanc Weiss	RAL 9006 Silver Aluminium Silber	RAL 7022 Shadow grey Gris ombre Dunkelgrau

Beams are always supplied in a silver finish.
Poutres toujours en finition aluminium.
Traverse in silberfarbener Ausführung.

Depending on the surface the color may vary slightly from the reference (RAL / NCS) provided.
En fonction de la surface, la couleur peut varier légèrement par rapport à la référence (RAL / NCS) fournie.
Je nach Oberfläche kann die Farbe in Bezug auf die RAL/NCS Referenz abweichen.

Creo and Greko high tables

Table hautes Creo et Greko
Hohe Tische Creo und Greko

W	D	H	CODE		OPTIONS (PTS)	CBM	KGS	PARCELS
L	P	H	REF.	PTS	OPTIONS (PTS)	MC	KG	COLIS
B	T	H	ART. NR.		VARIANTEN (PTS)	M ³	KG	KOLLI

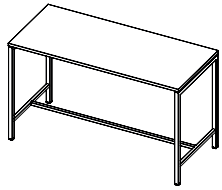

Creo high table

Creo, table haute plateau P. 80 cm
Creo, Schreibtisch

					TM			
160	80	107	LCRTR160	719	+186	0,190	48,9	5
180	80	107	LCRTR180	759	+186	0,210	54,8	5

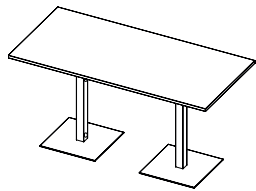

Greko high table

Greko, table haute P.100 cm
Greko, Konferenztisch

					TM			
210	100	107	LGRTR210	1012	+66	0,140	94,5	5



Index

Storage & Partitioning	305	BLOOM
	306	ZEFIRO
	309	LIBRERIA
	314	BOISERIE
	318	P1 BOISERIE
	320	M3

STORAGE & PARTITIONING

designed by Quadrifoglio Group



MELAMINE BACK PANEL / FOND EN MÉLAMINE / MELAMINRÜCKWAND

18mm melamine faced chipboard (MFC) finished with 1mm ABS impact resistant edging. Supplied in white (BA) or anthracite (TA) to match side panels. MFC panel density: 670/730 kgs per cubic meter.

Réalisé en aggloméré de 18 mm d'épaisseur, chant en mélamine anti-reflets et anti-rayures en fonction de la couleur des côtés, en blanc (BA) ou en tissu anthracite (TA), bordé en ABS anti-choc d'épaisseur 1 mm. Assemblés en haut et en bas avec des quincaillerie spécifique.
Densité du panneau : 670/730 kg/m³.

Aus Holzkonglomerat 18mm stark, mit 4-seitiger schlagfesten ABS Kante 1mm stark, mit reflexfreier und kratzfester Melamin Weiß (BA) oder Leinengrau (TA) beschichtet. Mit Abdeckplatte und Boden mittels Spezialbeschlägen zusammengestellt. Dichte der Platte: 670/730 kg/m³.

MELAMINE BOTTOM AND DIVIDERS / PANNEAU DE DESSOUS ET DE SÉPARATION / BODEN UND TRENNUNGEN IN MELAMIN

18mm melamine faced chipboard (MFC) finished with 1mm ABS impact resistant edging. Supplied in white (BA) or anthracite (TA) to match side panels. MFC panel density: 670/730 kgs per cubic meter.

Réalisés en aggloméré de 18 mm d'épaisseur, chant en mélamine anti-reflets et anti-rayures en fonction de la couleur des côtés, en blanc (BA) ou en tissu anthracite (TA), bordés en ABS anti-choc d'épaisseur 1 mm. Assemblés au top, au fond et aux côtés avec des quincaillerie spécifique. Densité du panneau : 670/730 kg/m³.

Aus Holzkonglomerat 18mm stark, an den sichtbaren Stellen mit 4-seitiger schlagfesten ABS Kante 1mm stark, mit reflexfreier und kratzfester Melamin Weiß (BA) oder Leinengrau (TA) beschichtet, je nach Farbe der Außenseiten. Mit Abdeckplatte, Rückwand und Außenseiten mittels Spezialbeschlägen zusammengestellt. Dichte der Platte: 670/730 kg/m³.

Finishes

Finitions

Ausführungen

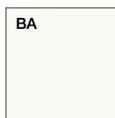

White
Blanc
Weiss



Anthracite linen
Tissu gris
Leinen grau

GLASS SHELVES / ETAGÈRES EN VERRE / GLASBÖDEN

Shelves manufactured in 6mm thickness toughened clear glass with 45° polished edges. Shelf supports with non-slip rubber pads.

Réalisés en verre transparent, trempé, épaisseur 6 mm, avec chant fil lucide plat et coins arrondis à 45°. Appuyés sur taquets pour étagères avec inserts en caoutchouc.

Aus 6mm starkem klarem Hartglas, mit einer flachen polierten Kante und 45° abgeschrägten Kanten. Auf Bodenträgern mit Gummieinsätzen gelegen.

Finishes

Finitions

Ausführungen



Clear Glass
Verre transparent
Klarglas

METAL FRAME / CADRE MÉTALLIQUE / METALLRAHMEN

30×30mm 2mm steel tube, powder coated in "R" anthracite finish.

Cadre réalisé en tube d'acier décapé, à section carré, 30×30 mm, en épaisseur 2 mm, verni à poudre époxy finition gris ombre R.

Rahmen aus gebeiztem Profilrohr, mit Vierkantquerschnitt 30×30mm, St.2mm, epoxidpulverbeschichtet in der Farbe Dunkelgrau R.

Finishes

Finitions

Ausführungen

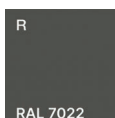

Shadow grey
Gris ombre
Dunkelgrau

Specification sheet
Caractéristiques techniques
Technische Beschreibungen

LACQUERED MELAMINE SIDES / CÔTÉS DE FINITION EN MÉLAMINE LAQUÉE / AUSSENSEITEN IN LACKIERTER MELAMIN

18mm melamine faced chipboard (MFC) finished with 1mm ABS impact resistant edging, 45° mitred front and top edges, external surface and edges lacquered in matt colours, internal surface in white (BA) or anthracite (TA) melamine.
 Side and top are connected by a 45° mitred joint. MFC panel density: 670/730 kgs per cubic meter.

Réalisés en aggloméré de 18 mm d'épaisseur, chants en ABS antichoc de 1 mm d'épaisseur, avec les faces frontales coupées à 45° et bordées de papier mélaminé. Partie extérieure et le long des bords peints en vernis mate, partie intérieure en mélamine anti-reflets et anti-rayures en fonction de la couleur, en blanc (BA) ou en tissu anthracite (TA). Assemblés en haut, à l'arrière et en bas avec des quincaillerie spécifique à 90°. Les côtés au niveau du joint entre les cotés et le plateau sont coupés à 45°. Densité du panneau : 670/730 kg/m3.

Aus Holzkonglomerat 18mm stark, mit 4-seitiger schlagfesten ABS Kante 1mm stark, mit Frontseiten in der Verbindung 45° auf Gehrung geschnitten, mit Melaminpapier umrandet. Außen und den Kanten entlang matt lackiert, innen in reflexfreier und kratzfester Melamin Weiß (BA) oder Leinengrau (TA), je nach Farbe. Mit Abdeckplatte, Rückwand und Boden mittels Spezialbeschlägen bei 90° zusammengestellt. Die Seiten und die Abdeckplatte in der Verbindung 45° auf Gehrung geschnitten. Dichte der Platte: 670/730 kg/m3.

LACQUERED MELAMINE TOPS / TOP EN MÉLAMINE LAQUÉ / ABDECKPLATTE IN LACKIERTER MELAMIN

18mm melamine faced chipboard (MFC) finished with 1mm ABS impact resistant edging, 45° mitred melamine front edge, external surface and edges lacquered in matt colours, internal surface in white (BA) or anthracite (TA) melamine depending on the lacquer finish.
 Top and sides are connected by a 45° mitred joint. MFC panel density: 670/730 kgs per cubic meter.

Réalisés en aggloméré de 18 mm d'épaisseur, chants en ABS antichoc de 1 mm d'épaisseur, avec les faces frontales coupées à 45° et bordées de papier mélaminé. Partie extérieure et le long des bords peints en vernis mat, partie intérieure en mélamine anti-reflets et anti-rayures en fonction de la couleur, en blanc (BA) ou en tissu anthracite (TA). Assemblés en haut, à l'arrière et en bas avec des quincaillerie spécifique à 90°. Les côtés au niveau du joint entre les cotés et le plateau sont coupés à 45°. Densité du panneau : 670/730 kg/m3.

Aus Holzkonglomerat 18mm stark, mit 4-seitiger schlagfesten ABS Kante 1mm stark, mit Frontseiten in der Verbindung 45° auf Gehrung geschnitten, mit Melaminpapier umrandet. Außen und den Kanten entlang matt lackiert, innen in reflexfreier und kratzfester Melamin Weiß (BA) oder Leinengrau (TA), je nach Farbe. Mit Außenseiten, Rückwand und Trennungen mittels Spezialbeschlägen bei 90° zusammengestellt. Die Seiten und die Abdeckplatte in der Verbindung 45° auf Gehrung geschnitten. Dichte der Platte: 670/730 kg/m3.

LACQUERED MELAMINE DOORS / PORTES EN MÉLAMINE LAQUÉ / TÜREN IN LACKIERTER MELAMIN

18mm melamine faced chipboard (MFC) fully lacquered in matt colours. Top and side edges 45° mitred and finished with melamine; bottom end finished with 1mm ABS impact resistant straight edging.D35. MFC panel density: 670/730 kgs per cubic meter.

Réalisés en aggloméré de 18 mm d'épaisseur, chants en ABS antichoc de 1 mm d'épaisseur, avec les faces frontales coupées à 45° et bordées de papier mélaminé, vernis en laqué mat. Densité du panneau : 670/730 kg/m3. Charnières avec ouverture 110°, réalisées en Zama et tôle imprimée, réglables en hauteur, largeur et profondeur. Barillet magnétique pour ouverture push-pull.

Aus Holzkonglomerat 18mm stark, mit 4-seitiger schlagfesten ABS Kante 1mm stark, mit Oberseite und mit Scharnieren ausgestatteter Seite in der Verbindung 45° auf Gehrung geschnitten, mit Melaminpapier umrandet, matt lackiert. Dichte der Platte: 670/730 kg/m3. Scharnieren mit 110° Öffnungswinkel, aus Blech, in der Höhe, Breite und Tiefe verstellbar. Mit magnetischer Ratsche für Push-Pull-Öffnung.

Finishes
 Finitions
 Ausführungen

LB RAL 9003 White Blanc Weiss	LL RAL 9002 Grey White Blanc Gris Grauweiss	LS RAL 7044 Silk Grey Gris Soie Seidengrau	NK NCS S 2010 Y30R Light Beige Beige clair Beige Hell	LE RAL 1019 Beige Beige Beige	LT RAL 7006 Beige Grey Gris Beige Beigegrau	NU RAL 8014 Dark Brown Marron foncé Dunkelbraun	NJ NCS S 4040 Y50R Burnt Orange Orange brûlé Verbrannte Orange
NW RAL 1006 Ocher Jaune moutard Ocker gelb	LA RAL 2000 Orange Orange Orange	LH RAL 3000 Flame Red Rouge Feu Feuerrot	LR RAL 3004 Purple Red Rouge Pourpre Purpurrot	LI RAL 3007 Black Red Rouge foncé Schwarz Rot	LZ RAL 5003 Sapphire Blue Bleu Saphire Saphirblau	NQ NCS S 5030 R80B Cobalt Blue Bleu Cobalt Kobaltblau	LC RAL 5014 Pigeon Blue Bleu Pigeon Tauben Blau
LD RAL 5020 Ocean Blue Bleu Océan Ozeanblau	LP RAL 6028 Pine Green Vert pin Kieferngrün	NV NCS S 6020 G70Y Olive Green Vert olive Olivgrün	LF RAL 7047 Telegrey 4 Telegris 4 Telegrau 4	LG RAL 7004 Grey Gris Grau	LO RAL 7022 Umbra Grey Gris Ombre Umbragrau	LN RAL 9017 Traffic Black Noir Signalisation Verkehrsschwarz	

Production lead time: 5 weeks exclusive of delivery time. Apart from the shown finish options any RAL color can be made to order.
 Délai de fabrication: 5 semaines; tous les finitions RAL sont disponibles sur requête

Lieferzeit: 5 Wochen; zusätzlich zu den vorgeschlagenen Lackierungen sind alle Ausführungen der RAL-Skala verfügbar

In sideboards with "mixed" finishes, stoneware and veneered determine the finish of the body interior.

Wenn das Sideboard mit gemischten Dekoren konfiguriert wird, wird die Korpusfarbe automatisch je nach Farbe der Außenteile/Türen und Abdeckplatte bestimmt.
 Concernant les buffets avec finitions "mixtes", les teintes du grès et du placage choisie déterminent la finition de la coque intérieure du buffet.

VENEERED SIDES / CÔTÉS DE FINITION EN PLACAGE BOIS / HOLZFURNIERTE AUSSENSEITEN

18mm melamine faced chipboard (MFC) finished with 1mm wood edging, 45° mitred front and top edges, 0.6mm open pore matt varnished veneer external surface and edges, internal surface in anthracite (TA) melamine. Side and top are connected by a 45° mitred joint.
MFC panel density: 670/730 kgs per cubic meter.

Réalisés en aggloméré de 18 mm d'épaisseur, plaqués de bois de 0,6 mm d'épaisseur à l'extérieur; réalisés à l'intérieur en toile mélaminée anthracite (TA) anti-reflets et anti-rayures, bordés sur le périmètre de bois de 1 mm, avec côtés frontaux coupés à 45° et bordés de bois. Peints à l'extérieur et sur les bords en peinture transparent mat à pores semi-ouverts Assemblés en haut, à l'arrière et en bas avec visserie à 90°. Les côtés à la jonction entre les côtés et le dessus sont coupés à 45°. Densité du panneau : 670/730 kg/m3.

Aus Holzkonglomerat 18mm stark, außen furniert Holzdicke 0,6mm, innen in reflexfreier und kratzfester Melamin Leinengrau (TA), mit 4-seitiger Holzkante 1mm stark, mit Frontseiten 45° auf Gehrung geschnitten, mit Holz bekantet. Außen und an den Kanten in halboffenporigem Matttransparent lackiert. Mit Abdeckplatte, Rückwand und Boden mittels Spezialbeschlägen bei 90° zusammengestellt. Die Seiten und die Abdeckplatte in der Verbindung 45° auf Gehrung geschnitten. Dichte der Platte: 670/730 kg/m3.

VENEERED TOPS / TOP EN PLACAGE BOIS / HOLZFURNIERTE ABDECKPLATTE

18mm melamine faced chipboard (MFC) finished with 1mm wood edging, 45° mitred wood front edge, 0.6mm open pore matt varnished veneer external surface and edges, internal surface in anthracite (TA) melamine. Top and sides are connected by a 45° mitred joint.
MFC panel density: 670/730 kgs per cubic meter.

Réalisés en aggloméré de 18 mm d'épaisseur, plaqués de bois de 0,6 mm d'épaisseur à l'extérieur; réalisés à l'intérieur en toile mélaminée anthracite (TA) anti-reflets et anti-rayures, bordés sur le périmètre de bois de 1 mm, avec côtés frontaux coupés à 45° et bordés de bois. Peints à l'extérieur et sur les bords en peinture transparent mat à pores semi-ouverts Assemblés en haut, à l'arrière et en bas avec visserie à 90°. Les côtés à la jonction entre les côtés et le dessus sont coupés à 45°. Densité du panneau : 670/730 kg/m3.

Aus Holzkonglomerat 18mm stark, außen furniert Holzdicke 0,6mm, innen in reflexfreier und kratzfester Melamin Leinengrau (TA), mit 4-seitiger Holzkante 1mm stark, mit Frontseiten 45° auf Gehrung geschnitten, mit Holz bekantet. Außen und an den Kanten in halboffenporigem Matttransparent lackiert. Mit Außenseiten, Rückwand und Trennungen mittels Spezialbeschlägen bei 90° zusammengestellt. Die Seiten und die Abdeckplatte in der Verbindung 45° auf Gehrung geschnitten. Dichte der Platte: 670/730 kg/m3.

VENEERED DOORS / PORTES EN PLACAGE BOIS / HOLZFURNIERTE TÜREN

18mm melamine faced chipboard (MFC) finished with 0.6mm open pore matt varnished veneer layers. 45° mitred top and side edges, straight bottom end edges, all finished with 1mm wood edging. Push&pull handleless door supplied with metal hinges allowing 110° opening, height-width-depth adjustable. Push to open magnetic latch. MFC panel density: 670/730 kgs per cubic meter.

Réalisés en aggloméré de 18 mm d'épaisseur, plaqués de bois de 0,6 mm d'épaisseur sur les deux cotés; bordés sur le périmètre de bois de 1 mm, avec coté supérieur et coté charnières à 45° et bordés en bois. Vernis transparents mat à pore semi-ouvert. Densité du panneau : 670/730 kg/m3. Charnières avec ouverture 110°, réalisées en Zama et tôle imprimée, réglables en hauteur, largeur et profondeur. Barillet magnétique pour ouverture push-pull.

Aus Holzkonglomerat 18mm stark, beidseitig furniert Holzdicke 0,6mm, mit 4-seitiger Holzkante 1mm stark, mit Oberseite und mit Scharnieren ausgestatteter Seite in der Verbindung 45° auf Gehrung geschnitten, mit Holz bekantet. In halboffenporigem Matttransparent lackiert. Dichte der Platte: 670/730 kg/m3. Scharnieren mit 110° Öffnungswinkel, aus Blech, in der Höhe, Breite und Tiefe verstellbar. Mit magnetischer Ratsche für Push-Pull-Öffnung.

Finishes Finitions Ausführungen

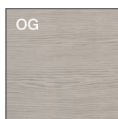

Elm
Orme gris
Ulme grau

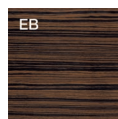

Ebony
Ébène
Ebenholz



American walnut
Noyer américain
Nußbaum

Specification sheet
Caractéristiques techniques
Technische Beschreibungen

PORCELAIN SIDES / CÔTÉS DE FINITION REVÊTUS EN GRÈS / AUSSENSEITEN MIT FEINSTEINZEUG BEZOGEN

18mm melamine faced chipboard (MFC) finished with 1mm ABS impact resistant edging, bonded to a 3-5mm porcelain top, 1.5mm straight edge and upper/lower 45° bevels. The MFC base is supplied in white (BA) or anthracite (TA) depending on the porcelain finish. 45° mitred melamine front edge. Side and top are connected by a 45° mitred joint. MFC panel density: 670/730 kgs per cubic meter.

Réalisés en couplant, par encollage, une plaque grès épaisseur 3 ou 5 mm à un panneau en aggloméré épaisseur 18 mm. Plaques de grès avec chant fil plat et coins arrondis à 45°. Panneaux en aggloméré, revêtues en mélamine antireflet et anti-rayures blanc (BA) ou tissu anthracite (TA) selon le couleur du grès, bordés en ABS antichoc épaisseur 1 mm, avec côtés coupés à 45° et avec chant en papier mélaminé. Assemblés au top, sol et fond par visserie spécifique à 90°. Les parties en jonction entre côtés et top sont coupés à 45°.

Hergestellt durch Aufkleben einer 3 oder 5 mm dicken Steinzeugplatte auf eine 18 mm dicke Holzspanplatte. Steinzeugplatten mit flachem Rand und 45° abgerundeten Ecken. Paneele aus Holzkonglomerat, mit reflexfreier und kratzfester Melamin beschichtet, in Weiß (BA) oder Leinengrau (TA) je nach Farbe des Feinsteinzeugs, mit 4-seitiger schlagfester ABS-Kante 1mm stark, mit Frontseiten 45° auf Gehrung geschnitten, mit Melaminpapier bekantet. Mit Abdeckplatte, Rückwand und Boden mittels Spezialbeschlägen bei 90° zusammengestellt. Die Seiten und die Abdeckplatte in der Verbindung 45° auf Gehrung geschnitten.

PORCELAIN TOPS / TOP REVÊTU EN GRÈS / ABDECKPLATTE MIT FEINSTEINZEUG BEZOGEN

18mm melamine faced chipboard (MFC) finished with 1mm ABS impact resistant edging, bonded to a 3-5mm porcelain top, 1.5mm straight edge and upper/lower 45° bevels. The MFC base is supplied in white (BA) or anthracite (TA) depending on the porcelain finish. 45° mitred melamine front edge. Top and sides are connected by a 45° mitred joint. MFC panel density: 670/730 kgs per cubic meter.

Réalisé en couplant, par encollage, une plaque grès épaisseur 3 ou 5 mm à un panneau en aggloméré épaisseur 18 mm. Plaques de grès avec chant fil plat et coins arrondis à 45°. Panneau en aggloméré, revêtu en mélamine antireflet et anti-rayures blanc (BA) ou tissu anthracite (TA) selon le couleur du grès, bordés en ABS antichoc épaisseur 1 mm, avec côtés coupés à 45° et avec chant en papier mélaminé. Assemblé aux côtés et au fond par visserie spécifique à 90°. Les parties en jonction entre côtés et top sont coupés à 45°.

Hergestellt durch Aufkleben einer 3 oder 5 mm dicken Steinzeugplatte auf eine 18 mm dicke Holzspanplatte. Steinzeugplatten mit flachem Rand und 45° abgerundeten Ecken. Paneel aus Holzkonglomerat, mit reflexfreier und kratzfester Melamin beschichtet, in Weiß (BA) oder Leinengrau (TA) je nach Farbe des Feinsteinzeugs, mit 4-seitiger schlagfester ABS-Kante 1mm stark, mit Frontseiten 45° auf Gehrung geschnitten, mit Melaminpapier bekantet. Mit Abdeckplatte, Rückwand und Boden mittels Spezialbeschlägen bei 90° zusammengestellt. Die Seiten und die Abdeckplatte in der Verbindung 45° auf Gehrung geschnitten.

PORCELAIN DOORS / PORTES REVÊTUES EN GRÈS / TÜREN MIT FEINSTEINZEUG BESCHICHTET

18mm melamine faced chipboard (MFC) bonded to a 3-5mm porcelain top, 1.5mm straight edge and upper/lower 45° bevels. The MFC base top and side edges are 45° mitred and finished with melamine; bottom end finished with 1mm ABS impact resistant straight edging. The melamine comes in white (BA) or anthracite (TA) depending on the porcelain finish. Push&pull handleless door supplied with metal hinges allowing 110° opening, height-width-depth adjustable. Push to open magnetic latch. MFC panel density: 670/730 kgs per cubic meter.

Réalisés en couplant, par encollage, une plaque grès épaisseur 3 ou 5 mm à un panneau en aggloméré épaisseur 18 mm. Plaques de grès avec chant fil plat et coins arrondis à 45°. Panneau en aggloméré, revêtu en mélamine antireflet et anti-rayures blanc (BA) ou tissu anthracite (TA) selon le couleur du grès, bordés en ABS antichoc épaisseur 1 mm, avec côtés coupés à 45° et avec chant en papier mélaminé. Densité panneau: 670/730 kg/m3. Charnières avec ouverture 110°, réalisées en Zama et tôle imprimée, réglables en hauteur, largeur et profondeur. Barillet magnétique pour ouverture push-pull.

Hergestellt durch Aufkleben einer 3 oder 5 mm dicken Steinzeugplatte auf eine 18 mm dicke Holzspanplatte. Steinzeugplatten mit flachem Rand und 45° abgerundeten Ecken. Paneel aus Holzkonglomerat, mit reflexfreier und kratzfester Melamin beschichtet, in Weiß (BA) oder Leinengrau (TA) je nach Farbe des Feinsteinzeugs, mit 4-seitiger schlagfester ABS-Kante 1mm stark, mit Frontseiten 45° auf Gehrung geschnitten, mit Melaminpapier bekantet. Dichte der Platte: 670/730 kg/m3. Scharnieren mit 110° Öffnungswinkel, aus Blech, in der Höhe, Breite und Tiefe verstellbar. Mit magnetischer Ratsche für Push-Pull-Öffnung.

Finishes
 Finitions
 Ausführungen

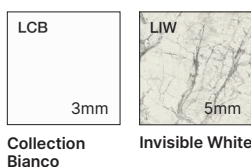

Finishes
 Finitions
 Ausführungen

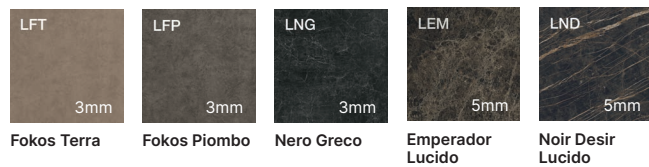

Interior body finishes:
 Ausführungen für den Korpus:
 Finitions de la coque:

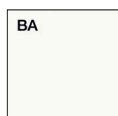

Interior body finishes:
 Ausführungen für den Korpus:
 Finitions de la coque:



BRIDGY



METAL GOALPOST LEGS / PIEDS ARCHE EN MÉTAL / U-FÜSSE AUS METALL

ø25mm round steel legs, 30×25mm 2mm steel crossbeam, powder coated in matt colours or liquid coated featuring a metallic effect. 0-15mm adjustable levelling feet.

Pieds réalisés en tube d'acier décapé, section ronde diam. 25mm, traverse horizontale section 30×25mm en épaisseur 2mm. Vernis à poudre époxy dans les coloris mats ou à liquide avec effets métalliques. Vérins de réglage 0-15 mm.

Füße aus gebeiztem Profilrohr, mit rundem Querschnitt D.25mm, horizontale Traverse mit Querschnitt 30×25mm, St-2mm. Epoxidpulverbeschichtet in Mattfarben oder flüssig beschichtet mit Metalleffekten. Mit Nivellierfüßen 0-15mm.

Finishes

Finitions

Ausführungen

O	R	OR *	BR *	CO *
RAL 9010	RAL 7022			
Matt white Blanc mat Weiss matt	Umbr Grey Gris ombre Dunkelgrau	Gold Or Gold	Bronze Bronze Bronze	Corten Corten Korten

* Production lead time: 5 weeks
Délai de fabrication: 5 semaines
Lieferzeit: 5 Wochen

FLAIR

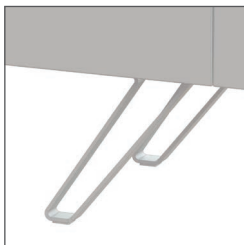

METAL HAIRPIN LEGS / PIEDS EN TÔLE MÉTALLIQUE / BLECHFÜSSE

30×5mm hairpin steel legs powder coated in matt colours or liquid coated featuring a metallic effect.

Pieds réalisés en tube d'acier décapé, section 30×5mm, vernis à poudre époxy dans les coloris mats ou à liquide avec effets métalliques.

Füße aus gebeiztem Profilblech, mit Querschnitt 30×5mm, epoxidpulverbeschichtet in Mattfarben oder flüssig beschichtet mit Metalleffekten

Finishes

Finitions

Ausführungen

O	R	OR *	BR *	CO *
RAL 9010	RAL 7022			
Matt white Blanc mat Weiss matt	Umbr Grey Gris ombre Dunkelgrau	Gold Or Gold	Bronze Bronze Bronze	Corten Corten Korten

* Production lead time: 5 weeks
Délai de fabrication: 5 semaines
Lieferzeit: 5 Wochen

Specification sheet
 Caractéristiques techniques
 Technische Beschreibungen

EDEN



WOODEN CONE-SHAPED LEGS / PIEDS CONIQUE EN BOIS / KONISCHE HOLZFÜSSE

Varnished solid ash wood legs taper from $\varnothing 38\text{mm}$ (upper end) to $\varnothing 24\text{mm}$ (lower end).
 0-15mm adjustable levelling feet.

Pieds réalisés en bois de frêne, à section conique ronde, section initiale diamètre 38mm (finale diamètre 24 mm), vernis. Vérins de réglage 0-15 mm.

Füße aus Eschenholz, mit rundem Querschnitt, Anfangsschnitt D.38mm (Endschnitt D.24mm), lackiert. Mit Nivellierfüßen 0-15mm.

Finishes Finitions Ausführungen



Gold
 Or
 Gold



Bronze
 Bronze
 Bronze

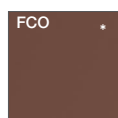

Corten
 Corten
 Korten



Matt white
 Blanc mat
 Weiss matt



Oak
 Chêne
 Eiche hell



Walnut
 Noyer
 Nuss

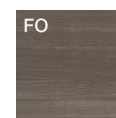

Elm
 Orme
 Ulme



Umbra Grey
 Gris ombre
 Dunkelgrau

* **Production lead time: 5 weeks**
 Délai de fabrication: 5 semaines
 Lieferzeit: 5 Wochen

CARCASS / STRUCTURE / KORPUSSE

Bottom, top and sides made from 18mm easy to clean scratch-resistant anti-reflective melamine faced chipboard (MFC), back panels in 8mm MFC, shelves in 25mm MFC. Panel density: 670/730 kgs per cubic meter.

Côtés, top et sol ép. 18 mm, dos ép. 8 mm et étagères en ép. 25 mm réalisés en aggloméré, revêtu avec papier mélaminé anti-rayures, antireflet et lavable. Densité panneau: 670/730 kg/m³.

Abschluss-, Ober- und Unterseite 18 mm, Rückenlehnen 8 mm, Einlegeböden 25 mm stark aus Holzkonglomerat, mit reflexfreiem, kratzfestem und waschbarem Melamin beschichtet. Plattendichte: 670/730 kg/m³.

Finishes

Finitions

Ausführungen



HINGED DOORS IN MELAMINE FACED CHIPBOARD (MFC) / PORTES BATTANTES EN MELAMINE / MELAMINBESCHICHTETE DREHTÜREN

Made from 18mm easy to clean scratch-resistant anti-reflective melamine faced chipboard (MFC) finished with 1.5mm matching ABS impact resistant edge. Panel density: 670/730 kgs per cubic meter. Height/width/depth adjustable anti-corrosion treated metal hinges allowing 105° door opening.

Réalisées en aggloméré mélaminé ép. 18mm anti-rayures, antireflet et lavable, avec chants en ABS en 1,5 mm antichoc sur les 4 côtés. Densité panneau: 670/730 kg/m³. Charnières avec ouverture à 105°, réalisées en tôle traitée contre la corrosion, réglables en hauteur, largeur et profondeur.

Aus Holzkonglomerat 18mm stark, mit reflexfreiem, kratzfestem und waschbarem Melamin beschichtet, mit 4-seitiger schlagfesten ABS Kante 1,5 mm stark. Plattendichte: 670/730 kg/m³. Scharniere mit 105° Öffnungswinkel, aus gepresstem und korrosionsgeschütztem Blech, in der Höhe, Breite und Tiefe verstellbar. Inkl.

Finishes

Finitions

Ausführungen

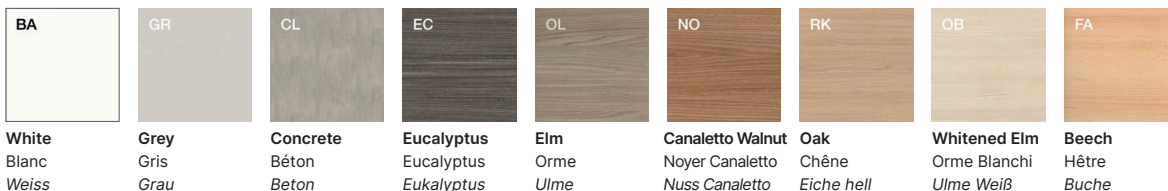

HINGED DOORS IN RECONSTITUTED VENEER / PORTES BATTANTES EN PLACAGE BOIS / HOLZFURNIERTE DREHTÜREN

Made from 19mm veneered particle board, 0.6mm wood veneer on both surfaces, finished with 1mm veneer edging, 0.5mm radiused corners. Matt transparent semi-open pore varnish. Panel density: 720/790 kgs per cubic meter. Height/width/depth adjustable anti-corrosion treated metal hinges allowing 105° door opening.

Portes en ép. total 19 mm, réalisées en aggloméré mélaminé ép. 18 mm, placage bois ép. 0,6 mm des deux côtés avec chants périphériques en bois épaisseur 1 mm, coins rayonnés 0,5 mm et verni transparent mat à pore semi-ouvert. Densité panneau: 720/790 kg/m³. Charnières avec ouverture à 105°, réalisées en tôle traitée contre la corrosion, réglables en hauteur, largeur et profondeur.

Aus 19 mm starker Holzkonglomeratplatte, beidseitig furnierte Holzdicke 0,6 mm, mit 1 mm starker abgerundeten Holzdicke. Oberfläche halboffenporig transparent lackiert. Plattendichte: 720/790 kg/m³. Scharniere mit 105° Öffnungswinkel, aus gepresstem und korrosionsgeschütztem Blech, in der Höhe, Breite und Tiefe verstellbar.

Finishes

Finitions

Ausführungen



Specification sheet
 Caractéristiques techniques
 Technische Beschreibungen

**HINGED DOORS IN LACQUERED MELAMINE FACED CHIPBOARD (MFC) /
 PORTES BATTANTES EN MELAMINE LAQUE / LACKIERTE DREHTÜREN**

Made from 18mm easy to clean scratch-resistant anti-reflective melamine faced chipboard (MFC) finished with 1.5mm matching ABS impact resistant edges. The surface is coated using matt lacquers in a variety of colors. Panel density: 670/730 kgs per cubic meter. Height/width/depth adjustable anti-corrosion treated metal hinges allowing 105° door opening.

Réalisées en aggloméré mélaminé ép. 18mm anti-rayures, antireflet et lavable, avec chants en ABS en 1,5 mm antichoc sur les 4 côtés et laquées mat. Densité panneau: 670/730 kg/m3. Charnières avec ouverture à 105°, réalisées en tôle traitée contre la corrosion, réglables en hauteur, largeur et profondeur.

Aus Holzkonglomerat 18mm stark, mit reflexfreiem, kratzfestem und waschbarem Melamin beschichtet, mit 4-seitiger schlagfesten ABS Kante 1,5 mm stark. Ausführung matt lackiert. Plattendichte: 670/730 kg/m3. Scharniere mit 105° Öffnungswinkel, aus gepresstem und korrosionsgeschütztem Blech, in der Höhe, Breite und Tiefe verstellbar.

Finishes
 Finitions
 Ausführungen

LB RAL 9003 White Blanc Weiss	LL RAL 9002 Grey White Blanc Gris Grauweiss	LS RAL 7044 Silk Grey Gris Soie Seidengrau	NK NCS S 2010 Y30R Light Beige Beige clair Beige Hell	LE RAL 1019 Beige Beige Beige	LT RAL 7006 Beige Grey Gris Beige Beige-grau	NU RAL 8014 Dark Brown Marron foncé Dunkelbraun	NJ NCS S 4040 Y50R Burnt Orange Orange brûlé Verbrannte Orange
NW RAL 1006 Ocher Jaune moutard Ockergelb	LA RAL 2000 Orange Orange Orange	LH RAL 3000 Flame Red Rouge Feu Feuerrot	LR RAL 3004 Purple Red Rouge Pourpre Purpurrot	LI RAL 3007 Black Red Rouge foncé Schwarz Rot	LZ RAL 5003 Sapphire Blue Bleu Saphire Saphirblau	NQ NCS S 5030 R80B Cobalt Blue Bleu Cobalt Kobaltblau	LC RAL 5014 Pigeon Blue Bleu Pigeon Tauben Blau
LD RAL 5020 Ocean Blue Bleu Océan Ozeanblau	LP RAL 6028 Pine Green Vert pin Kieferngrün	NV NCS S 6020 G70Y Olive Green Vert olive Olivgrün	LF RAL 7047 Telegrey 4 Telegris 4 Telegrau 4	LG RAL 7004 Grey Gris Grau	LO RAL 7022 Umbra Grey Gris Ombre Umbragrau	LN RAL 9017 Traffic Black Noir Signalisation Verkehrsschwarz	

Production lead time: 5 weeks exclusive of delivery time. Apart from the shown finish options any RAL color can be made to order.

Délai de fabrication: 5 semaines; tous les finitions RAL sont disponibles sur requête

Lieferzeit: 5 Wochen; zusätzlich zu den vorgeschlagenen Lackierungen sind alle Ausführungen der RAL-Skala verfügbar

**LEATHER COVERED HINGED DOORS / PORTES EN MÉLAMINE REVÊTUES EN CUIR /
 LEDERBEZOGENE DREHTÜREN**

Made from 18mm melamine faced chipboard (MFC) finished with matching straight melamine edges. Panel density: 670/730 kgs per cubic meter. The door is covered with 1.3mm abrasion resistant leather finished with matching decorative stitching along the perimeter of the panel. Height/width/depth adjustable anti-corrosion treated metal hinges allowing 105° door opening.

Réalisées en aggloméré ép. 18 mm, revêtu avec papier mélaminé. Densité panneau: 670/730 kg/m3. Les deux côtés et les chants sont revêtus en cuir ép.1,3 mm avec coutures en teinte tout autour. Charnières avec ouverture à 105°, réalisées en tôle traitée contre la corrosion, réglables en hauteur, largeur et profondeur.

Aus Holzkonglomerat 18 mm stark mit Melaminpapier beschichtet. Plattendichte: 670/730 kg/m3. Frontal und seitlich mit 1,3 mm starkem, regeneriertem Leder bezogen, mit passenden Ziernähten. Scharniere mit 105° Öffnungswinkel, aus gepresstem und korrosionsgeschütztem Blech, in der Höhe, Breite und Tiefe verstellbar.

Finishes
 Finitions
 Ausführungen

CRS Red Rouge Rot	CMA Brown Brun Braun	CGA Anthracite Anthracite Anthrazit	CNE Black Noir Schwarz
-----------------------------------	--------------------------------------	---	--

HANDLES / POIGNÉES / GRIFFE

Zen



+ PTS 5

Silver (Z)
Aluminium (Z)
Silber (Z)

White (A)
Blanc (A)
Weiss (A)

Shadow grey (Q)
Gris ombre (Q)
Dunkelgrau (Q)

Chrome (Y)
Chromé (Y)
Verchromt (Y)

Gold (ZO)
Or (ZO)
Gold (ZO)

Bronze (ZB)
Bronze (ZB)
Bronze (ZB)

Corten (ZC)
Corten (ZC)
Corten (ZC)

LEGS / VÉRIN / FUSS



1. Standard feet: five $\varnothing 50$ mm 27mm high polyethylene feet, 0-15mm adjustable $\varnothing 25$ mm levellers.
2. PLANE: PVC plinth.
3. SMART: rectangular 20x60mm 150mm high metal leg supplied with 0-15mm adjustable $\varnothing 25$ mm levellers. Profile and cladding side panels are required.
4. ROUND: Round $\varnothing 50$ mm 150mm high ABS leg supplied with 0-10mm adjustable $\varnothing 52$ mm levellers. Profile and cladding side panels are required.
5. CLASSY: aluminium 146mm high organic legs, supplied with 0-10mm adjustable $\varnothing 18$ mm levellers.
6. CLASSY+: aluminium 146mm high organic legs with external decorative profile. Supplied with 0-10mm adjustable $\varnothing 18$ mm levellers. Not to be used with storage with cladding side panels.
7. FAIRY: aluminium 146mm high organic legs with middle decorative cavity, supplied with 0-10mm adjustable $\varnothing 18$ mm levellers.
8. FAIRY: aluminium 146mm high organic legs with middle decorative cavity and external decorative profile. Supplied with 0-10mm adjustable $\varnothing 18$ mm levellers. Not to be used with storage with cladding side panels.

1. Petit pieds standard: n. 5 vérins en PE, $\varnothing 50$ mm, h. 27 mm, $\varnothing 25$ mm avec réglage 0-15 mm.
2. PLANE: socle en PVC.
3. SMART: petits pieds métallique, section rectangulaire 20x60 mm, h. 150 mm, $\varnothing 25$ mm, avec réglage 0-15 mm. Profil et côtés de finition obligatoires.
4. ROUND: petits pieds en ABS, section ronde, $\varnothing 50$ mm, h. 150 mm, $\varnothing 52$ mm, avec réglage 0-10 mm. Profil et côtés de finition obligatoires.
5. CLASSY: pieds en alu h. 146 mm avec vérins de réglage $\varnothing 18$ mm avec réglage 0-10 mm.
6. CLASSY+: pieds en alu h.146mm avec profil décoratif externe. Vérins de réglage $\varnothing 18$ mm avec réglage 0-10 mm. Pas possible avec armoires avec côtés de finition.
7. FAIRY: pieds en alu à forme creuse h. 146 mm avec vérins de réglage $\varnothing 18$ mm avec réglage 0-10 mm.
8. FAIRY+: pieds en alu à forme creuse h.146mm avec profil décoratif externe. Vérins de réglage $\varnothing 18$ mm avec réglage 0-10 mm. Pas possible avec armoires avec côtés de finition.

1. Standardfüße: N. 5 PE-Füße, $\varnothing 50$ mm, H. 27 mm, mit Richtmodul $\varnothing 25$ mm, Bereich 0-15 mm.
2. PLANE: Sockel aus Kunststoff.
3. SMART: Metallfuß, rechteckiger Querschnitt 20x60mm, H. 150mm; mit Richtmodul $\varnothing 25$ mm, Bereich 0-15mm. Sockel Profileiste und Abschlußseiten notwendig.
4. ROUND: Fuß aus ABS, runder Querschnitt, $\varnothing 50$ mm, H. 150 mm, mit Richtmodul $\varnothing 52$ mm, Bereich 0-10 mm. Sockel Profileiste und Abschlußseiten notwendig.
5. CLASSY: Alufuß H.146mm mit Richtmodul $\varnothing 18$ mm, Bereich 0-10mm.
6. CLASSY+: Alufuß H.146mm mit dekorativem Außenprofil lieferbar. Richtmodul $\varnothing 18$ mm, Bereich 0-10mm. Nicht geeignet für schränke mit Abschlußseiten.
7. FAIRY: Alufuß H.146mm mit Richtmodul $\varnothing 18$ mm, Bereich 0-10mm.
8. FAIRY: Alufuß H.146mm mit dekorativem Außenprofil lieferbar. Richtmodul $\varnothing 18$ mm, Bereich 0-10mm. Nicht geeignet für schränke mit Abschlußseiten.

Specification sheet

Caractéristiques techniques

Technische Beschreibungen

STRUCTURE / STRUCTURE / KORPUSFARBE

38mm easy to clean scratch-resistant anti-reflective melamine faced chipboard (MFC) side panels and shelves finished with 2mm matching straight ABS impact resistant edges. Shelves are fitted using provided concealed shelf supports enabling the shelves to be height adjustable in 32mm increments. Height adjustable levelling feet and bottom plinth in anodized aluminium.

Côtés et étagères en aggloméré épaisseur 38 mm, revêtus en papier mélaminé anti-rayures et antireflet et lavables avec chants en ABS ép. 2 mm en teinte. Les étagères sont équipées de taquets métalliques cachés qui permettent le réglage en hauteur de la tablette tous les 32 mm. La structure a des vérins de réglage et un jeu de socles en profil alu anodisé.

Wangen und Fachböden aus 38 mm starkem melaminbeschichteten Holzkonglomerat, reflexfrei und kratzfest, 4-seitig umrandet in passendem, stoßfestem ABS, 2 mm stark. Die Fachböden sind mit versenkbaren Metall-Fachbodenträgern ausgestattet und ermöglichen die Höhenverstellung der Fachhäer alle 32 mm. Die Wangen sind mit Nivellierfüßen und einem Paar Sockeln aus eloxiertem Aluminiumprofil ausgestattet.

BACK PANEL / FOND / RÜCKWAND



18mm easy to clean scratch-resistant anti-reflective melamine faced chipboard (MFC) back panels finished with 2mm matching straight ABS impact resistant edges. At least one 860mm wide back panel or alternatively two 430mm wide back panels are mandatory for any Libreria configuration to ensure stability and avoid wobbling.

Réalisé en aggloméré épaisseur 18 mm, revêtus en papier mélaminé anti-rayures et antireflet et lavables avec chants en ABS ép. 2 mm en teinte. Afin d'assurer la stabilité de la composition, il faut prévoir au moins 1 fond largeur 86 cm ou 2 fonds largeur 43 cm.

Aus 18 mm starkem Holzkonglomerat, mit Melaminpapier überzogen, reflexfrei und kratzfest, 4-seitig umrandet mit passendem, stoßfestem ABS, 2 mm stark. Um die Stabilität der Zusammensetzung zu gewährleisten, muss mindestens eine 860 mm breite Rückwand oder zwei 430 mm breite Rückwand positioniert werden.

Finishes

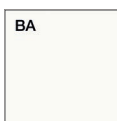
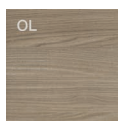
Finitions
Ausführungen

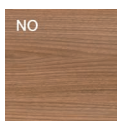
			
BA White Blanc Weiss	OL Elm Orme Ulme	EC Eucalyptus Eucalyptus Eukalyptus	NO Canaletto Walnut Noyer Canaletto Nuss Canaletto

							
LB RAL 9003 White Blanc Weiss	LL RAL 9002 Grey White Blanc Gris Grauweiss	LS RAL 7044 Silk Grey Gris Soie Seidengrau	NK NCS S 2010 Y30R Light Beige Beige clair Beige Hell	LE RAL 1019 Beige Beige Beige	LT RAL 7006 Beige Grey Gris Beige Beige-grau	NU RAL 8014 Dark Brown Marron foncé Dunkelbraun	NJ NCS S 4040 Y50R Burnt Orange Orange brûlé Verbrannte Orange
							
NW RAL 1006 Ocher Jaune moutard Ockergelb	LA RAL 2000 Orange Orange Orange	LH RAL 3000 Flame Red Rouge Feu Feuerrot	LR RAL 3004 Purple Red Rouge Pourpre Purpurrot	LI RAL 3007 Black Red Rouge foncé Schwarz Rot	LZ RAL 5003 Sapphire Blue Bleu Saphire Saphirblau	NQ NCS S 5030 R80B Cobalt Blue Bleu Cobalt Kobaltblau	LC RAL 5014 Pigeon Blue Bleu Pigeon Tauben Blau
							
LD RAL 5020 Ocean Blue Bleu Océan Ozeanblau	LP RAL 6028 Pine Green Vert pin Kieferngrün	NV NCS S 6020 G70Y Olive Green Vert olive Olivgrün	LF RAL 7047 Telegrey 4 Telegris 4 Telegrau 4	LG RAL 7004 Grey Gris Grau	LO RAL 7022 Umbra Grey Gris Ombre Umbragrau	LN RAL 9017 Traffic Black Noir Signalisation Verkehrsschwarz	

Production lead time: 5 weeks exclusive of delivery time. Apart from the shown finish options any RAL color can be made to order.

Délai de fabrication: 5 semaines; tous les finitions RAL sont disponibles sur requête

Lieferzeit: 5 Wochen; zusätzlich zu den vorgeschlagenen Lackierungen sind alle Ausführungen der RAL-Skala verfügbar

MFC HINGED DOORS / PORTES EN MÉLAMINE / MELAMINTÜREN





18mm easy to clean scratch-resistant anti-reflective melamine faced chipboard (MFC) doors finished with 1.5mm matching straight ABS impact resistant edges. Height/width/depth adjustable anti-corrosion treated metal hinges allowing 105° door opening. Doors can be supplied with or without lock except 450H small doors which always come non-locking.

Réalisées en aggloméré épaisseur 18 mm, revêtus en papier mélaminé anti-rayures et antireflet et lavables avec chants en ABS ép. 1,5 mm en teinte. Charnières avec ouverture à 105°, réalisées en tôle traitée contre la corrosio, réglables en hauteur, largeur et profondeur.

Aus 18 mm starkem Holzkonglomerat, mit Melaminpapier beschichtet, reflexfrei und kratzfest, 4-seitig mit passendem, stoßfestem ABS, 1,5 mm stark. Scharniere mit 105° Öffnungswinkel, aus gepresstem und korrosionsgeschütztem Blech, in Höhe, Breite und Tiefe verstellbar.

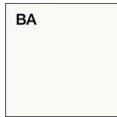
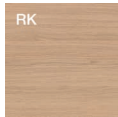
Finishes

Finitions
Ausführungen

						
White Blanc Weiss	Grey Gris Grau	Oak Chêne Eiche hell	Concrete Béton Beton	Elm Orme Ulme	Eucalyptus Eucalyptus Eukalyptus	Canaletto Walnut Noyer Canaletto Nuss Canaletto

LACQUERED MFC HINGED DOORS / PORTES EN MÉLAMINE LAQUÉES / MELAMINTÜREN LACKIERT

18mm easy to clean scratch-resistant anti-reflective melamine faced chipboard (MFC) lockable doors finished with 1.5mm matching straight ABS impact resistant edges. The MFC surface is coated using matt lacquers in a variety of colors. Height/width/depth adjustable anti-corrosion treated metal hinges allowing 105° door opening. Doors can be supplied with or without lock except 450H small doors which always come non-locking.

Réalisées en aggloméré épaisseur 18 mm, revêtus en papier mélaminé anti-rayures et antireflet et lavables avec chants en ABS ép. 1,5 mm en teinte, vernies en laqué mat en plusieurs finitions. Charnières avec ouverture à 105°, réalisées en tôle traitée contre la corrosio, réglables en hauteur, largeur et profondeur.

Aus 18 mm starkem Holzkonglomerat, mit Melaminpapier beschichtet, reflexfrei und kratzfest, 4-seitig mit passendem, stoßfestem ABS, 1,5 mm stark. Scharniere mit 105° Öffnungswinkel, aus gepresstem und korrosionsgeschütztem Blech, in Höhe, Breite und Tiefe verstellbar.

Finishes

Finitions
Ausführungen

							
RAL 9003 White Blanc Weiss	RAL 9002 Grey White Blanc Gris Gruweiss	RAL 7044 Silk Grey Gris Soie Seidengrau	NCS S 2010 Y30R Light Beige Beige clair Beige Hell	RAL 1019 Beige Beige Beige	RAL 7006 Beige Grey Gris Beige Beigegrau	RAL 8014 Dark Brown Marron foncé Dunkelbraun	NCS S 4040 Y50R Burnt Orange Orange brûlé Verbrannte Orange
							
RAL 1006 Ocher Jaune Océan Ockergelb	RAL 2000 Orange Orange Orange	RAL 3000 Flame Red Rouge Feu Feuerrot	RAL 3004 Purple Red Rouge Pourpre Purpurrot	RAL 3007 Black Red Rouge foncé Schwarz Rot	RAL 5003 Sapphire Blue Bleu Saphire Saphirblau	NCS S 5030 R80B Cobalt Blue Bleu Cobalt Kobaltblau	RAL 5014 Pigeon Blue Bleu Pigeon Tauben Blau
							
RAL 5020 Ocean Blue Bleu Océan Ozeanblau	RAL 6028 Pine Green Vert pin Kieferngrün	NCS S 6020 G70Y Olive Green Vert olive Olivgrün	RAL 7047 Telegrey 4 Telegris 4 Telegrau 4	RAL 7004 Grey Gris Grau	RAL 7022 Umbra Grey Gris Ombre Umbragrau	RAL 9017 Traffic Black Noir Signalisation Verkehrsschwarz	

Production lead time: 5 weeks exclusive of delivery time. Apart from the shown finish options any RAL color can be made to order.

Délai de fabrication: 5 semaines; tous les finitions RAL sont disponibles sur requête

Lieferzeit: 5 Wochen; zusätzlich zu den vorgeschlagenen Lackierungen sind alle Ausführungen der RAL-Skala verfügbar

Specification sheet

Caractéristiques techniques

Technische Beschreibungen

LEATHER COVERED HINGED DOORS / PORTES EN MÉLAMINE REVÊTUES EN CUIR / MELAMIN-TÜREN MIT LEDERBEZUG

18mm melamine faced chipboard (MFC) finished with matching straight melamine edges. The door is covered with 1.3mm abrasion resistant leather finished with matching decorative stitching along the perimeter of the panel. Height/width/depth adjustable anti-corrosion treated metal hinges allowing 105° door opening.

Réalisées en aggloméré épaisseur 18 mm, revêtus en papier mélaminé anti-rayures et antireflet et lavables avec chants en ABS ép. 1,5 mm en teinte, revêtues en cuir régénéré ép. 13/10 mm, avec coutures décoratives en teinte sur tout le périmètre. La partie extérieure est dans une seule pièce pliée sur quatre côtés pour couvrir l'épaisseur de la porte et après, encore pliée à l'intérieure (pour quelques cm) pour cacher les jointions visibles dans la partie extérieure. Charnières avec ouverture à 105°, réalisées en tôle traitée contre la corrosion, réglables en hauteur, largeur et profondeur.

Aus 18 mm starker Holzkonglomeratplatte, die mit Melaminpapier beschichtet und mit Papier umrandet ist. Die Außen- und Innenseiten und -kanten der Platte sind mit 13/10 mm starkem regeneriertem Leder bezogen, mit passenden Ziernähten am Umfang. Das Leder auf der Außenseite ist ein einziges Stück, das auf allen vier Seiten aufgeklappt ist, um die Tiefe der Tür abzudecken, und dann auf der Innenseite (um einige Zentimeter) aufgeklappt, um keine Fugen an den Außenseiten zu sehen. Der mittlere Teil der Innenseite ist mit einem zweiten Lederstück bezogen. Scharniere mit 105° Öffnungswinkel, aus gepresstem und korrosionsgeschütztem Blech, in Höhe, Breite und Tiefe verstellbar.

Finishes

Finitions
Ausführungen

			
CRS	CMA	CGA	CNE
Red Rouge Rot	Brown Brun Braun	Anthracite Anthracite Anthrazit	Black Noir Schwarz

Production lead time: 5 weeks exclusive of delivery time.
Délai de fabrication: 5 semaines.
Produktionszeit: 5 Wochen

HANDLES / POIGNÉES / GRIFFE

ZEN



Silver (Z)
Aluminium (Z)
Silber (Z)

White (A)
Blanc (A)
Weiss (A)

Shadow grey (Q)
Gris ombre (Q)
Dunkelgrau (Q)

Chrome (Y)
Chromé (Y)
Verchromt (Y)

Gold (ZO)
Or (ZO)
Gold (ZO)

Bronze (ZB)
Bronze (ZB)
Bronze (ZB)

Corten (ZC)
Corten (ZC)
Corten (ZC)

MFC BACK PANELS / FONDS EN MÉLAMINE / RÜCKWÄNDE IN MELAMIN

18mm melamine faced chipboard (MFC) finished with 1.5mm matching straight ABS impact resistant edges, easy to clean scratch-resistant anti-reflective melamine. Supplied with levelling feet.

Réalisés en aggloméré épaisseur 18 mm, revêtus en papier mélaminé anti-rayures et antireflet et lavables avec chants en ABS ép. 1,5 mm en teinte, avec vérins de réglage au sol.

Aus 18 mm starkem Holzkonglomerat, mit Melaminpapier überzogen, reflektions- und kratzfest, eingefasst in passendem, stoßfestem ABS, 1,5 mm stark, ausgestattet mit Nivellierfüßen auf dem Boden.

MFC SIDE PANELS / CÔTÉS EN MÉLAMINE / ABSCHLUSSEITEN AUS MELAMIN

8mm melamine faced chipboard (MFC) finished with matching straight melamine edges, easy to clean scratch-resistant anti-reflective melamine.

Réalisés en aggloméré épaisseur 8 mm, revêtus en papier mélaminé anti-rayures et antireflet et lavables avec chants en teinte.

Aus 8 mm starkem Holzkonglomerat, mit Melaminpapier überzogen, mit Papier umrandet.

MFC HINGED DOORS / PORTES EN MÉLAMINE / MELAMINTÜREN

18mm melamine faced chipboard (MFC) finished with 1.5mm matching straight ABS impact resistant edges, easy to clean scratch-resistant anti-reflective melamine. Anti-corrosion treated metal hinges allowing 105° door opening, height/width/depth adjustable.





Réalisées en aggloméré épaisseur 18 mm, revêtus en papier mélaminé anti-rayures et antireflet et lavables avec chants en ABS ép. 1,5 mm en teinte. Charnières avec ouverture à 105°, réalisées en tôle traitée contre la corrosion, réglables en hauteur, largeur et profondeur.

Aus 18 mm starkem Holzkonglomerat, mit Melaminpapier beschichtet, reflexfrei und kratzfest, 4-seitig mit passendem, stoßfestem ABS, 1,5 mm stark. Scharniere mit 105° Öffnungswinkel, aus gepresstem und korrosionsgeschütztem Blech, in Höhe, Breite und Tiefe verstellbar.

Finishes

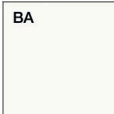
Finitions

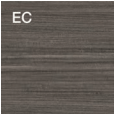
Ausführungen

			
White Blanc Weiss	Elm Orme Ulme	Eucalyptus Eucalyptus Eukalyptus	Canaletto Walnut Noyer Canaletto Nuss Canaletto

LEATHER COVERED HINGED DOORS / PORTES EN MÉLAMINE REVÊTUES EN CUIR / MELAMIN-TÜREN MIT LEDERBEZUG

18mm melamine faced chipboard (MFC) finished with matching straight melamine edges. The door is covered with 1.3mm abrasion resistant leather finished with matching decorative stitching along the perimeter of the panel. Anti-corrosion treated metal hinges allowing 105° door opening, height/width/depth adjustable.

Réalisées en aggloméré épaisseur 18 mm, revêtus en papier mélaminé anti-rayures et antireflet et lavables avec chants en ABS ép. 1,5 mm en teinte, revêtues en cuir régénéré ép. 13/10 mm, avec coutures décoratives en teinte sur tout le périmètre. La partie extérieure est dans une seule pièce pliée sur quatre côtés pour couvrir l'épaisseur de la porte et après, encore pliée à l'intérieure (pour quelques cm) pour cacher les jointures visibles dans la partie extérieure. Charnières avec ouverture à 105°, réalisées en tôle traitée contre la corrosion, réglables en hauteur, largeur et profondeur.

Aus 18 mm starker Holzkonglomeratplatte, die mit Melaminpapier beschichtet und mit Papier umrandet ist. Die Außen- und Innenseiten und -kanten der Platte sind mit 13/10 mm starkem regeneriertem Leder bezogen, mit passenden Ziernähten am Umfang. Das Leder auf der Außenseite ist ein einziges Stück, das auf allen vier Seiten aufgeklappt ist, um die Tiefe der Tür abzudecken, und dann auf der Innenseite (um einige Zentimeter) aufgeklappt, um keine Fugen an den Außenseiten zu sehen. Der mittlere Teil der Innenseite ist mit einem zweiten Lederstück bezogen. Scharniere mit 105° Öffnungswinkel, aus gepresstem und korrosionsgeschütztem Blech, in Höhe, Breite und Tiefe verstellbar.

Finishes

Finitions

Ausführungen

			
Red Rouge Rot	Brown Brun Braun	Anthracite Anthracite Anthrazit	Black Noir Schwarz

Specification sheet

Caractéristiques techniques

Technische Beschreibungen

LACQUERED MFC BACK PANELS / FONDS EN MÉLAMINE LAQUÉ / RÜCKWÄNDE IN MELAMIN LACKIERT

18mm melamine faced chipboard (MFC) finished with 1.5mm matching straight ABS impact resistant edges, easy to clean scratch-resistant anti-reflective melamine. These panels are supplied with a matt lacquered surface in a variety of colors. Complete with levelling feet.

Réalisés en aggloméré épaisseur 18 mm, revêtus en papier mélaminé anti-rayures et antireflet et lavables avec chants en ABS ép. 1,5 mm et vernis en laqué mat en plusieurs finitions. Fonds avec vérins de réglage au sol.

Aus 18 mm starkem Holzkonglomerat, mit reflexfreiem und kratzfestem Melaminpapier überzogen, aus schlagfestem ABS, 1,5 mm stark und mit Mattlack in verschiedenen Farben lackiert. Die Rückenlehnen sind mit Nivellierfüßen am Boden ausgestattet.

LACQUERED MFC SIDE PANELS / CÔTÉS EN MÉLAMINE LAQUÉ / ABSCHLUSSEITEN AUS MELAMIN LACKIERT

8mm melamine faced chipboard (MFC) finished with matching straight melamine edges, easy to clean scratch-resistant anti-reflective melamine. Supplied with a matt lacquered surface in a variety of colors.

Réalisés en aggloméré épaisseur 8 mm, revêtus en papier mélaminé anti-rayures et antireflet et lavables, vernis en laqué mat en plusieurs finitions.

Aus 8 mm starkem Holzkonglomerat, mit Melaminpapier überzogen, mit Papier umrandet und mit Mattlack in verschiedenen Farben lackiert.

LACQUERED MFC HINGED DOORS / PORTES EN MÉLAMINE LAQUÉES / MELAMINTÜREN LACKIERT

Lacquered 18mm melamine faced chipboard (MFC) finished with 1.5mm matching straight ABS impact resistant edges, easy to clean scratch-resistant anti-reflective melamine. Anti-corrosion treated metal hinges allowing 105° door opening, height/width/depth adjustable.

Réalisées en aggloméré épaisseur 18 mm, revêtus en papier mélaminé anti-rayures et antireflet et lavables avec chants en ABS ép. 1,5 mm en teinte, vernies en laqué mat en plusieurs finitions. Charnières avec ouverture à 105°, réalisées en tôle traitée contre la corrosio, réglables en hauteur, largeur et profondeur.

Aus 18 mm starkem Holzkonglomerat, mit Melaminpapier beschichtet, reflexfrei und kratzfest, 4-seitig mit passendem, stoßfestem ABS, 1,5 mm stark. Scharniere mit 105° Öffnungswinkel, aus gepresstem und korrosionsgeschütztem Blech, in Höhe, Breite und Tiefe verstellbar.

Finishes

Finitions

Ausführungen

LB RAL 9003 White Blanc Weiss	LL RAL 9002 Grey White Blanc Gris Grauweiss	LS RAL 7044 Silk Grey Gris Soie Seidengrau	NK NCS S 2010 Y30R Light Beige Beige clair Beige Hell	LE RAL 1019 Beige Beige Beige	LT RAL 7006 Beige Grey Gris Beige Beigegrau	NU RAL 8014 Dark Brown Marron foncé Dunkelbraun	NJ NCS S 4040 Y50R Burnt Orange Orange brûlé Verbrannte Orange
NW RAL 1006 Ocher Jaune moutard Ockergelb	LA RAL 2000 Orange Orange Orange	LH RAL 3000 Flame Red Rouge Feu Feuerrot	LR RAL 3004 Purple Red Rouge Pourpre Purpurrot	LI RAL 3007 Black Red Rouge foncé Schwarz Rot	LZ RAL 5003 Sapphire Blue Bleu Saphire Saphirblau	NQ NCS S 5030 R80B Cobalt Blue Bleu Cobalt Kobaltblau	LC RAL 5014 Pigeon Blue Bleu Pigeon Tauben Blau
LD RAL 5020 Ocean Blue Bleu Océan Ozeanblau	LP RAL 6028 Pine Green Vert pin Kieferngrün	NV NCS S 6020 G70Y Olive Green Vert olive Olivgrün	LF RAL 7047 Telegrey 4 Telegris 4 Telegrau 4	LG RAL 7004 Grey Gris Grau	LO RAL 7022 Umbra Grey Gris Ombre Umbragrau	LN RAL 9017 Traffic Black Noir Signalisation Verkehrsschwarz	

Production lead time: 5 weeks exclusive of delivery time. Apart from the shown finish options any RAL color can be made to order.

Délai de fabrication: 5 semaines; tous les finitions RAL sont disponibles sur requête

Lieferzeit: 5 Wochen; zusätzlich zu den vorgeschlagenen Lackierungen sind alle Ausführungen der RAL-Skala verfügbar

HANDLES / POIGNÉES / GRIFFE

ZEN



Silver (Z)
Aluminium (Z)
Silber (Z)

White (A)
Blanc (A)
Weiss (A)

Shadow grey (Q)
Gris ombre (Q)
Dunkelgrau (Q)

Gold (ZO)
Or (ZO)
Gold (ZO)

Bronze (ZB)
Bronze (ZB)
Bronze (ZB)

Corten (ZC)
Corten (ZC)
Corten (ZC)

GLASS SHELVES / ETAGÈRES EN VERRE / GLASABLAGEN

10mm tempered extra white glass, painted and scratch resistant underside, satin fingerprint-proof top surface, smooth polished edges with 45° bevel and radius corners.

Realisés en verre trempé extra clair, épaisseur 10 mm, satinés dans la partie supérieure et vernis dans la partie inférieure; équipés aussi de plaques de fixations en acier inox. Ils ont des angles avec chant fil lucide plat et coins arrondis à 45°.

Aus extra klarem, gehärtetem Glas, 10 mm stark, auf der Oberseite satiniert und auf der Unterseite lackiert. Sie haben abgerundete Ecken mit einer glänzenden flachen Kante und 45° abgeschrägten Kanten.

Finishes
Finitions
Ausführungen

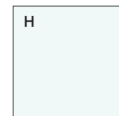

Matt white
Blanc opaque
Weiss matt

UPRIGHTS AND BEAMS / MONTANTS ET TRAVERSES / STOLLEN UND TRAVERSEN

Uprights made of extruded aluminium and beams of die-cast aluminium alloy, both supplied in four finish options: polished chrome effect, epoxy powder coated, soft touch fingerprint/scratch resistant matt polyester paint. Uprights upper end is finished with a chrome ABS end cap.

Montants verticaux en aluminium effet chromé ou vernis à poudre époxy ou vernis polyester mat, effet soft touch anti-taches et anti-rayures. Traverses horizontales de soutien pour les étagères, en alliage d'al, brillant effet chromé ou vernies à poudre époxy ou vernies polyester mat, effet soft touch anti-taches et anti-rayures.

Vertikale Standrohre aus poliertem stranggepresstem Aluminium mit Chromeffekt oder Epoxidpulverbeschichtung oder -lackierung mit mattem Polyester, Soft-Touch-Effekt, mit Anti-Fingerprint und reflexfreien Eigenschaften. Horizontale Traversen für die Regale, aus Aluminiumdruckgusslegierung, poliert verchromt oder epoxidbeschichtet oder mit mattem Polyester lackiert, Soft-Touch-Effekt mit Anti-Fingerprint und reflexfreien-Eigenschaften.

Finishes

Finitions

Ausführungen



RAL 9016

White
Blanc
Weiss

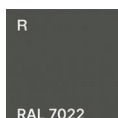

RAL 7022

Shadow grey
Gris ombre
Dunkelgrau



RAL 9010

Matt white
Blanc opaque
Weiss matt



Polished chrome
Brillant lucide
Hochglanzpoliert

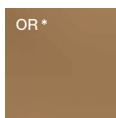

Gold
Or
Gold



Bronze
Bronze
Bronze



Corten
Corten
Korten

* Production lead time: 5 weeks
Délai de fabrication: 5 semaines
Lieferzeit: 5 Wochen

LEVELLING FEET / VÉRINS DE RÉGLAGE / NIVELLIERFÜSSE

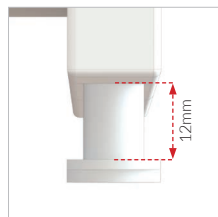

Back panels: 0-12mm adjustable levelling feet made from zamak, size 18.5×25mm.

Vérin fond en ZaMa, dimensions 18,5×25 mm, réglable en hauteur 0-12 mm.

Zynklegierung-Rückwandfuß, Maße 18,5×25 mm, höhenverstellbar von 0 bis 12 mm.

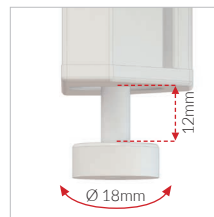

Uprights: 0-12mm adjustable levelling feet made of polyethylene, 18mm diameter.

Vérin montant en polyéthylène, Ø 18 mm, réglable en hauteur 0-12 mm.

Nivellierfuß für Pfosten aus Polyethylen, Ø 18 mm, höhenverstellbar von 0 bis 12 mm.

Technical features

Composabilité Aufbausystem

The Boiserie bookcase is available in two heights, 1350 and 2190mm and, thanks to its modular design, in a wide variety of length options. The components to construct Boiserie are back panels, uprights, shelves and side panels. Side panels must be specified to provide stability. The self-supporting uprights allow to place two Boiserie back to back as shown in Figure A. **Please note: we recommend to anchor Boiserie to the wall wherever necessary**

Les modules Boiserie sont disponibles en deux hauteurs: 135 et 219 cm; la complète modularité permet infinies solutions en largeur. La Boiserie est composée de fonds, montants, étagères et côtés de fermeture; les montants autoportants permettent de composer la Boiserie fond contre fond pour réaliser des ensembles double face (A). **N.B. La fixation au mur est toujours conseillé.**

Die Boiserie-Module sind in 2 Höhen, 135 und 219 cm erhältlich; dank der Modularität des Produkts können Kompositionen in verschiedenen Breiten erstellt werden. Die Boiserie besteht aus Rückwänden, Pfosten, Regalböden und Seitenwänden, die für die Stabilität der Kompositionen erforderlich sind. Die selbsttragenden Pfosten ermöglichen es, die Boiserie Seite an Seite, Rücken an Rücken zu platzieren und so doppelseitige Kompositionen zu schaffen (Abb. A). **Hinweis: Es wird immer empfohlen, die Boiserie-Module an der Wand zu befestigen.**

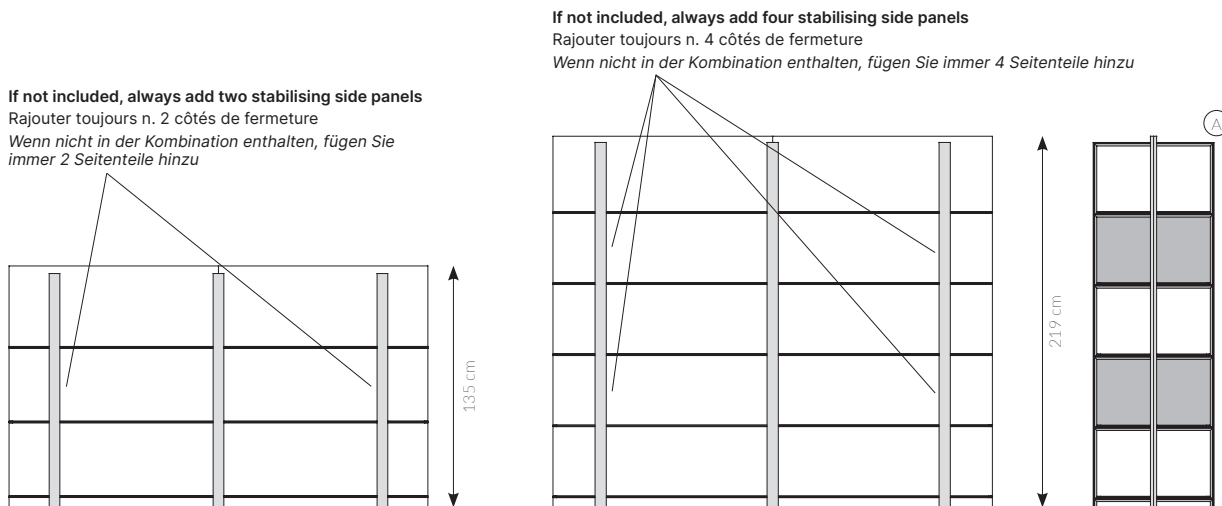

Boiserie can be supplied with MFC or framed glass hinged doors in four height options.

- The 830, 1270 and 2110mm high doors can be only positioned with their lower end at floor level, as shown in the figure to right. They cannot be positioned as shown in the figure to left.
- 450mm high doors can be positioned at any height. We remind you 450mm high doors are supplied without lock.

Les compositions Boiserie peuvent être avec portes en mélamine et portes en verre avec cadre dans les 4 hauteurs.

- Les portes en h. 83, 127 et 211 cm peuvent être positionner uniquement au niveau du sol, comme dans le dessin à droite.
- Pas possible la superposition comme dessous. Les portes en h. 45 cm (disponible que sans serrure) peuvent être à tous les niveaux.

Die Boiserie-Kompositionen können mit Melamin-Türen und Glasrahmentüren in 4 verschiedenen Höhen ausgestattet werden.

- Türen mit den Höhen 83, 127 und 211 cm können nur bodenbündig positioniert werden, wie rechts dargestellt.
- Sie können nicht übereinander gelegt werden, wie unten gezeigt. Die 45 cm hohen Türen (nur in der Ausführung OHNE Schloss erhältlich) können in jeder Höhe positioniert werden.

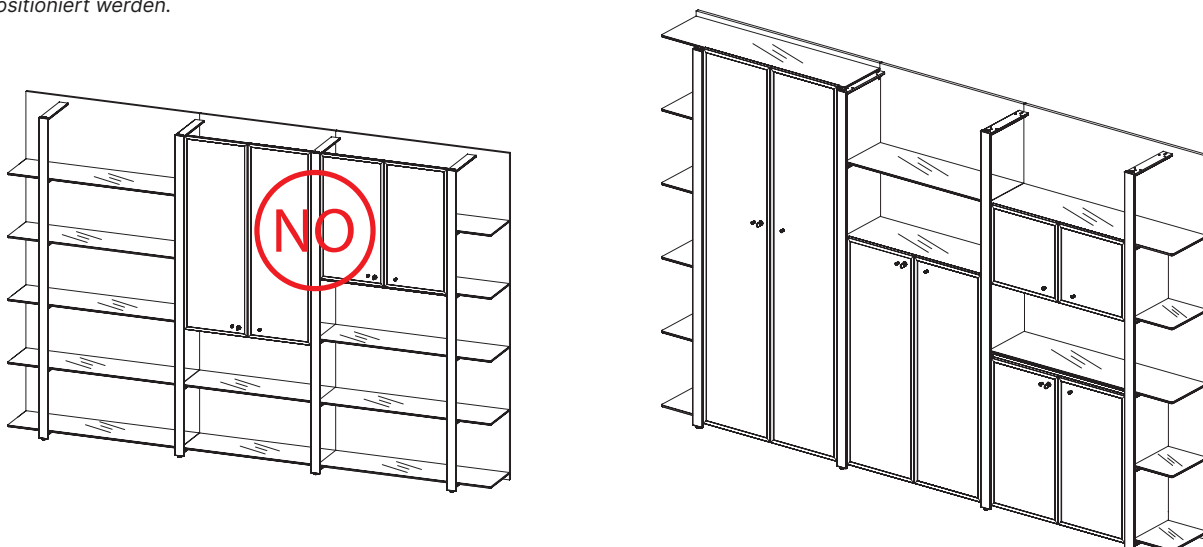

Where 2110mm high doors are used, an additional top must be specified:

- use item BORC1 when the 2110mm high door is positioned at a middle section of Boiserie;
- use item BORT2 when the 2110mm high door is positioned at an end section of Boiserie.

Avec les portes hauteur 211cm il est nécessaire de fermer la partie supérieure avec une étagère en plus:

- réf. BORC1 dans le cas des étagères en verre centrales;
- réf. BORT2 dans le cas des étagères en verre terminales.

Bei Türen mit einer Höhe von 211 cm ist es notwendig, das oberste Fach mit einer zusätzlichen Ablage im oberen Teil zu schließen:

- Art. BORC1 bei mittigen Glasablagen;
- Art. BORT2 bei seitlichen Glasablagen.

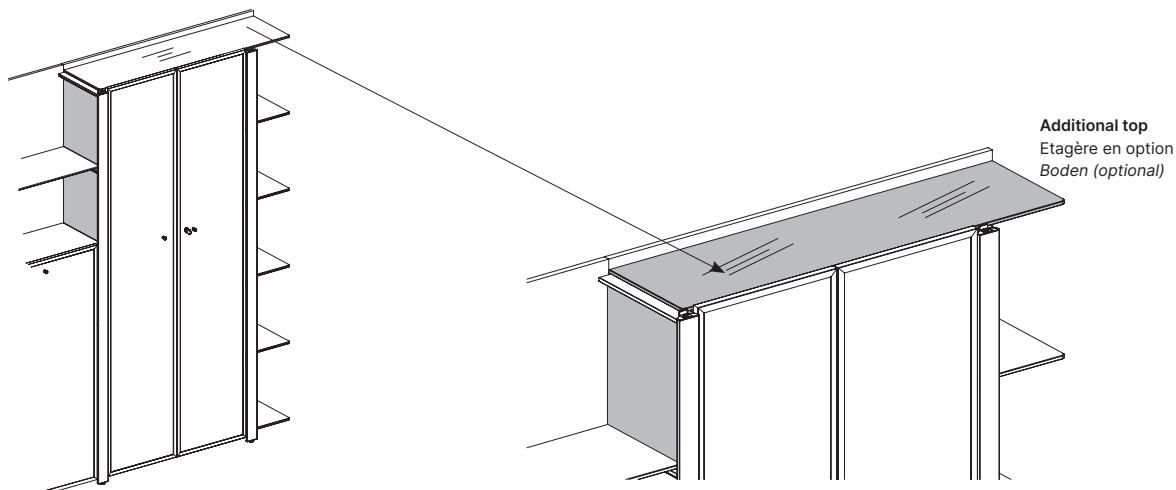

When Boiserie is supplied with hinged doors, MFC side panels must be specified on both sides of the door and fitted within shelves and uprights (A). Side panels can be specified even without hinged doors as space dividers. Please note: pre-priced Boiserie configurations already include side panels, if hinged doors are added to the configuration remove the side panel in excess if any.

Lorsque la Boiserie est équipée avec portes il est nécessaire de fermer toutes les deux parties avec des côtés de fermeture entre les étagères et les montants (A). Les côtés de fermeture peuvent être utilisés sans portes aussi pour diviser les espaces dans les étagères.

N.B. Les compositions Boiserie ont déjà inclus des côtés de fermeture: il faut donc enlever les côtés en plus si nécessaire

Wenn die Boiserie mit Türen ausgestattet ist, müssen die so entstandenen Abteilungen auf beiden Seiten mit Außenseiten geschlossen werden, die zwischen den Regalen und den Pfosten (A) montiert sind. Die Abschlusseiten können auch ohne Türen verwendet werden, um Unterbrechungen zwischen den einzelnen Abteilungen zu schaffen. Hinweis: Die Boiserie-Kompositionen beinhalten bereits Abschlußseiten: Wenn Sie Türen zu den Kompositionen hinzufügen, ziehen Sie bitte die überschüssige Abschlußseite ab.

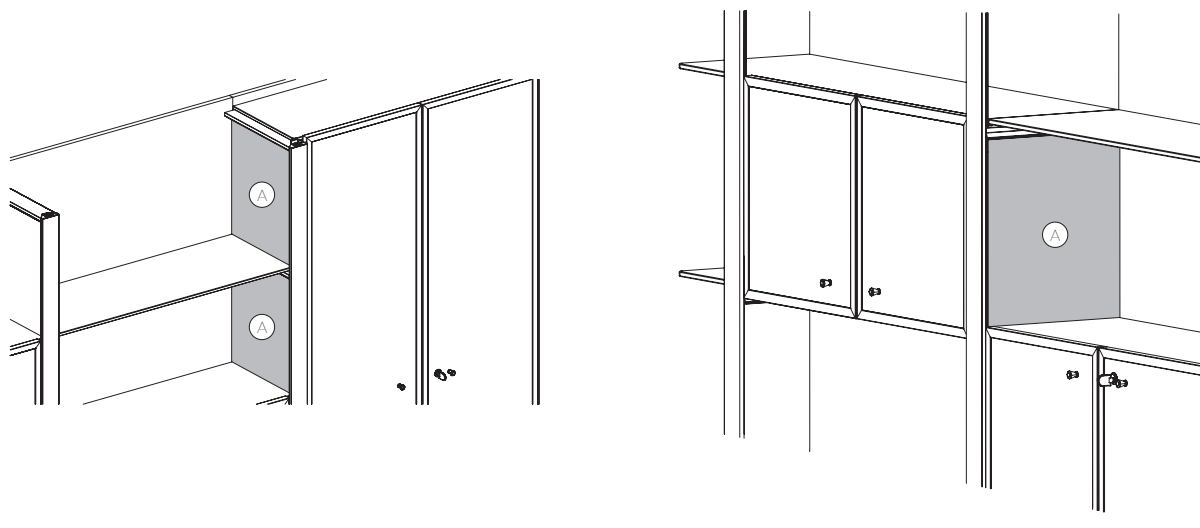

W	D	H	CODE		KGS	CBM	PARCELS
L	P	H	REF.	PTS	KG	MC	COLIS
B	T	H	ART. NR.		KG	M ³	KOLLI

Credenza W. 150 with lacquered doors, top and sides – Back in MFC

Buffet L.150 avec portes, top et côtés laqués – dos en mélamine

Sideboard B.150 mit lackierten Türen, Abdeckplatte und Außenseiten – Melaminrückwand

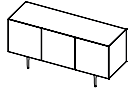

150,1	50,1	73,7	BLMA0150	1668	67,5	0,171	7
Veneered top / Top en plaquage bois / Holz furnierte Abdeckplatte				+190	67,5	0,171	7
Veneered sides / Côtés en plaquage bois / Holz furnierte Außenseiten				+139	67,5	0,171	7
Veneered doors / Portes en plaquage bois / Holz furnierte Türen				+380	67,5	0,171	7
Gres Top – 3mm edge / Top en grès ép. 3 mm / Abdeckplatte aus Feinsteinzeug St.3mm				+312	73	0,171	7
Gres sides – 3mm edge / Côtés en grès ép. 3 mm / Außenseiten aus Feinsteinzeug St.3mm				+278	71,5	0,171	7
Gres doors – 3mm edge / Portes en grès ép. 3 mm / Türen aus Feinsteinzeug St.3mm				+396	73	0,171	7
Gres Top – 5mm edge / Top en grès ép. 5 mm / Abdeckplatte aus Feinsteinzeug St.5mm				+443	77	0,171	7
Gres finishing sides – 5mm edge / Côtés en grès ép. 5 mm / Außenseiten aus Feinsteinzeug St.5mm				+365	74	0,171	7
Gres doors – 5mm edge / Portes en grès ép. 5 mm / Türen aus Feinsteinzeug St.5mm				+534	75,5	0,171	7
Feet in Gold (OR), Bronze (BR) or Corten (CR) / Pieds Or (OR), Bronze (BR) ou Corten (CR) / Füße in Gold (OR), Bronze (BR) oder Kupfer (CR)				+119			



Credenza W. 200 with lacquered doors, top and sides – Back in MFC

Buffet L.200 avec portes, top et côtés laqués – dos en mélamine

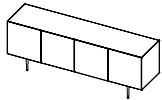
Sideboard B.200 mit lackierten Türen, Abdeckplatte und Außenseiten – Melaminrückwand



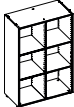
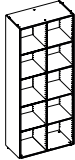
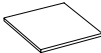



200,1	50,1	73,7	BLMA0200	2046	86	0,217	7
Veneered top / Top en plaquage bois / Holz furnierte Abdeckplatte				+251	86	0,217	7
Veneered sides / Côtés en plaquage bois / Holz furnierte Außenseiten				+139	86	0,217	7
Veneered doors / Portes en plaquage bois / Holz furnierte Türen				+507	86	0,217	7
Gres Top – 3mm edge / Top en grès ép. 3 mm / Abdeckplatte aus Feinsteinzeug St.3mm				+423	93,5	0,217	7
Gres sides – 3mm edge / Côtés en grès ép. 3 mm / Außenseiten aus Feinsteinzeug St.3mm				+278	90	0,217	7
Gres doors – 3mm edge / Portes en grès ép. 3 mm / Türen aus Feinsteinzeug St.3mm				+532	94	0,217	7
Gres Top – 5mm edge / Top en grès ép. 5 mm / Abdeckplatte aus Feinsteinzeug St.5mm				+622	98,5	0,217	7
Gres finishing sides – 5mm edge / Côtés en grès ép. 5 mm / Außenseiten aus Feinsteinzeug St.5mm				+365	92,5	0,217	7
Gres doors – 5mm edge / Portes en grès ép. 5 mm / Türen aus Feinsteinzeug St.5mm				+709	98,5	0,217	7
Feet in Gold (OR), Bronze (BR) or Corten (CR) / Pieds Or (OR), Bronze (BR) ou Corten (CR) / Füße in Gold (OR), Bronze (BR) oder Kupfer (CR)				+119			

	W	D	H	CODE	PTS	OPTIONS (PTS)	CBM	KGS	PARCELS
	L	P	H	REF.		OPTIONS (PTS)	MC	KG	COLIS
	B	T	H	ART. NR.		VARIANTEN (PTS)	M ³	KG	KOLLI
	Zefiro bookcase basic Biliothèque Zefiro basse Bücherregal Zefiro Sockel								
	86	42,6	86,1	LZFLIBA1	249	LA +435	0,090	32,0	3
Cladding top panel not included yet mandatory, to be ordered separately Dessus de finition pas inclus et obligatoire Abdeckplatte nicht inkl. und notwendig									
	Zefiro bookcase maxi Biliothèque Zefiro mi-hauteur Bücherregal Zefiro Maxi								
	86	42,6	130,9	LZFLIMA1	338	LA +624	0,130	46,0	4
Cladding top panel not included yet mandatory, to be ordered separately Dessus de finition pas inclus et obligatoire Abdeckplatte nicht inkl. und notwendig									
	Zefiro bookcase super Biliothèque Zefiro haute Bücherregal Zefiro Super								
	86	42,6	214,1	LZFLISU1	507	LA +976	0,200	73,0	5
	Melamine shelf Etagère en mélaminé Regal aus Melamin								
	40,2	41	1,8	LZFRIO01	32	LA +40	0,010	2,7	5
	Metal profile - add this item when metal legs for cabinets are specified Profil pour armoire Sockel Profileiste (Pflicht für Metall Füßen ZEPI150)								
	86	5	5	ZEZO860	37	TM +21	0,002	1,0	1
Available in four finish options: silver, white, anthracite or chrome Disponible en finition alu, blanc, gris ombre et chrome In den Farben alu, weiss, dunkelgrau oder verchromt									
	Plane, PVC plinth Plane, socle en PVC Plane, sockel aus Kunststoff								
	86	40	3	COZO860	46	TM +32	0,015	0,6	1
Available in three finish options: silver, white or anthracite Disponible en finition alu, blanc et gris ombre In den Farben alu, weiss oder dunkelgrau									

LA = Lacquered / Laqué / Lackiert

TM = Gold (OR), Bronze (BR) or Corten (CR) frame / Cadre Or (OR), Bronze (BR) ou Corten (CR) / Gestell in Gold (OR), Bronze (BR) oder Kupfer (CO)

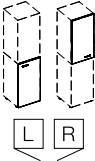
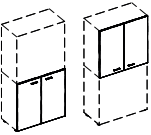
	W	D	H	CODE	PTS	OPTIONS (PTS)	CBM	KGS	PARCELS	
	L	P	H	REF.		OPTIONS (PTS)	MC	KG	COLIS	
	B	T	H	ART. NR.		VARIANTEN (PTS)	M ³	KG	KOLLI	
15 cm high Classy end/middle legs - set of 4										
Jeu de 4 petits pieds Classy terminaux/intermediares en H. 15 cm Bausatz 4 FüÙe Classy Endstücke/Mittelstücke H.15 cm										
	7,6	6,6	14,7	COPIC001	135	TM +85	0,010	1,6	1	
Set of 4 Classy legs + 15 cm end legs with decorative profiles										
Jeu de 4 petits pieds Classy+ terminaux en H. 15 cm, avec profils décoratifs Bausatz 4 FüÙe Classy+ Endstücke H.15 cm mit Verzierungsprofilen										
	7,6	6,6	29,8	COPIC002	205	TM +170	0,010	2,0	1	
15 cm high Fairy end/middle legs - set of 4										
Jeu de 4 petits pieds Fairy terminaux/intermediares en H. 15 cm Bausatz 4 FüÙe Fairy Endstücke/Mittelstücke H.15 cm										
	6,6	6,6	14,7	COPIF001	167	TM +98	0,010	1,4	1	
Set of 4 Fairy legs + 15 cm end legs with decorative profiles										
Jeu de 4 petits pieds Fairy terminaux en H. 15 cm, avec profils décoratifs Bausatz 4 FüÙe Fairy + Endstücke H.15 cm mit Verzierungsprofilen										
	6,6	6,6	29,4	COPIF002	225	TM +174	0,010	1,6	1	
Melamine hinged door - non-locking										
Porte mélaminé basse battante sans serrure Melamintür 2OH ohne SchloÙ										
						LA 4 AP AC				
R	43	1,8	83	LIDALSBD	73	+85 +19 +163 +228	0,023	4,6	1	
L	43	1,8	83	LIDALSBS	73	+85 +19 +163 +228	0,023	4,6	1	
Melamine double hinged doors - non-locking										
Jeu de 2 portes mélaminé basses battantes sans serrure Melamintüren 2OH ohne SchloÙ										
	86	1,8	83	LIDALDBA	109	LA 4 AP AC				
						+172 +30 +290 +464	0,028	9,1	1	

TM = Gold (OR), Bronze (BR) or Corten (CR) frame / Cadre Or (OR), Bronze (BR) ou Corten (CR) / Gestell in Gold (OR), Bronze (BR) oder Kupfer (CO)
 LA = Lacquered / Laqué / Lackiert
 4 = Soft close / Fermeture Soft / Soft VerschieÙung
 AP = Wood veneer doors / Portes en placage bois / Türen aus Holz furniert
 AC = Leather doors / Portes en cuir / Türen aus Leder

	W	D	H	CODE	PTS	OPTIONS (PTS)	CBM	KGS	PARCELS
	L	P	H	REF.		OPTIONS (PTS)	MC	KG	COLIS
	B	T	H	ART. NR.		VARIANTEN (PTS)	M ³	KG	KOLLI

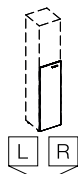

Melamine hinged door - non-locking
 Porte mélaminé mi-hauteur battante sans serrure
 Melamintür 3OH ohne Schloß

						LA	4	AP	AC			
R	43	1,8	128	LIDALSMD	94	+131	+19	+208	+269	0,034	7,0	1
L	43	1,8	128	LIDALSMS	94	+131	+19	+208	+269	0,034	7,0	1

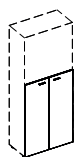

Melamine double hinged doors - non-locking
 Jeu de 2 portes mélaminé mi-hauteur battantes sans serrure
 Melamintüren 3OH ohne Schloß

						LA	4	AP	AC			
	86	1,8	128	LIDALDMA	148	+262	+30	+391	+555	0,039	13,9	1

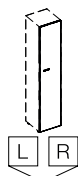

Melamine hinged door - non-locking
 Porte mélaminé haute battante avec serrure
 Melamintür 5OH ohne Schloß

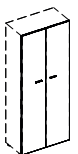

						LA	4	AP	AC			
R	43	1,8	211	LIDALSSD	136	+216	+30	+308	+387	0,054	11,6	1
L	43	1,8	211	LIDALSSS	136	+216	+30	+308	+387	0,054	11,6	1



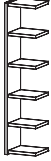

Melamine double hinged doors - non-locking
 Jeu de 2 portes mélaminé hautes battantes sans serrure
 Melamintüren 5OH ohne Schloß

						LA	4	AP	AC			
	86	1,8	211	LIDALDSU	209	+435	+42	+604	+801	0,067	22,8	1

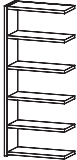
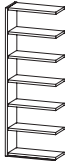
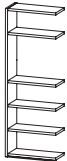
4 = Soft close / Fermeture Soft / Soft Verschiebung
 AP = Wood veneer doors / Portes en placage bois / Türen aus Holz furniert
 AC = Leather doors / Portes en cuir / Türen aus Leder
 LA = Lacquered / Laqué / Lackiert

	W	D	H	CODE	PTS	OPTIONS (PTS)	CBM	KGS	PARCELS	
	L	P	H	REF.	PTS	OPTIONS (PTS)	MC	KG	COLIS	
	B	T	H	ART. NR.		VARIANTEN (PTS)	M ³	KG	KOLLI	
	Module with 6 shelves - to be used as a starter Module terminal à 6 étagères Startmodul 5OH beidseitig verwendbar									
	47	44	215	LLIFI43S	542	LA +427	0,139	57,8	4	
	Module with 7 shelves - to be used as a starter Module terminal à 7 étagères Startmodul 6OH									
	47	44	256	LLIFI43A	639	LA +504	0,166	68,8	5	
	Module with 6 shelves and a gap to fill with the specific shelf for when a ladder is required - to be used as a starter Module terminal à 6 étagères pour échelle Startmodul 6OH für Einfügung der Treppe									
	47	44	256	LLIFS43A	570	LA +466	0,153	63,8	4	
	Module with 6 shelves - to be used as a starter Module terminal à 6 étagères Startmodul 5OH beidseitig verwendbar									
	90	44	215	LLIFI86S	729	LA +650	0,193	88,8	4	
	Module with 7 shelves - to be used as a starter Module terminal à 7 étagères Startmodul 6OH									
	90	44	256	LLIFI86A	856	LA +763	0,234	104,8	5	
	Module with 6 shelves and a gap to fill with the specific shelf for when a ladder is required - to be used as a starter Module terminal à 6 étagères pour échelle Startmodul 6OH für Einfügung der Treppe									
	90	44	256	LLIFS86A	757	LA +689	0,207	94,8	4	

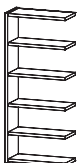
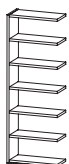
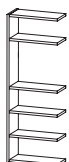
	W	D	H	CODE	PTS	OPTIONS (PTS)	CBM	KGS	PARCELS	
	L	P	H	REF.		OPTIONS (PTS)	MC	KG	COLIS	
	B	T	H	ART. NR.		VARIANTEN (PTS)	M ³	KG	KOLLI	
	Module with 6 shelves - to be used as an add-on Module intermédiaire à 6 étagères Folgemodul 5OH mit Einlegenböden									
	47	44	215	LLIDI43S	542	LA +427	0,140	57,8	4	
	Module with 7 shelves - to be used as an add-on Module intermédiaire à 7 étagères Folgemodul 6Oh mit Einlegenböden									
	47	44	256	LLIDI43A	639	LA +504	0,166	68,8	5	
	Module with 6 shelves and a gap to fill with the specific shelf for when a ladder is required - to be used as an add-on Module intermédiaire à 6 étagères pour échelle Folgemodul 6OH für Einfügung der Treppe									
	47	44	256	LLIDS43A	570	LA +466	0,153	63,8	4	
	Module with 6 shelves - to be used as an add-on Module intermédiaire à 6 étagères Folgemodul 5OH mit Einlegenböden									
	90	44	215	LLIDI86S	729	LA +650	0,194	88,8	4	
	Module with 7 shelves - to be used as an add-on Module intermédiaire à 7 étagères Folgemodul 6Oh mit Einlegenböden									
	90	44	256	LLIDI86A	815	LA +763	0,234	104,8	5	
	Module with 6 shelves and a gap to fill with the specific shelf for when a ladder is required - to be used as an add-on Module intermédiaire à 6 étagères pour échelle Folgemodul 6OH für Einfügung der Treppe									
	90	44	256	LLIDS86A	757	LA +689	0,207	94,8	4	

W	D	H	CODE	PTS	OPTIONS (PTS)	CBM	KGS	PARCELS
L	P	H	REF.		OPTIONS (PTS)	MC	KG	COLIS
B	T	H	ART. NR.		VARIANTEN (PTS)	M ³	KG	KOLLI



End side panel

Côté de fermeture
Abschlußseite

					LA				
4	44	215	LLIFISU0	207	+205	0,066	27,0	1	
4	44	256	LLIFISA0	233	+244	0,080	33,0	1	



Middle side panel, to be placed between two modules

Côté de séparation
Trennwand

					LA				
4	44	215	LLIDISU0	207	+205	0,067	27,0	1	
4	44	256	LLIDISA0	233	+244	0,080	33,0	1	



Back panel, at least one back panel is required in any configuration

Fond pour modules L. 43 cm
Rückwand für Modul B.43cm

					LA				
43	1,8	211	LLISH43S	152	+197	0,046	12,1	2	
43	1,8	256	LLISH43A	191	+237	0,053	14,6	2	



Back panel, at least one back panel is required in any configuration

Fond pour modules L. 86 cm
Rückwand für Modul B.86cm

					LA				
86	1,8	211	LLISH86S	210	+396	0,091	24,1	2	
86	1,8	256	LLISH86A	254	+474	0,098	28,9	2	

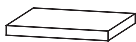

Melamine shelf

Etagère pour libreria
Einlegeboden Melamin

					LA				
43	40	4	LLIRI430	68	+37	0,013	5,0	1	
86	40	4	LLIRI860	100	+74	0,027	10,0	1	



Shelf supplied with metal rail for using with our hook-on ladder, rail on one side only

Étagère avec intégration pour échelle sur 1 côté
Einlegeboden Melamin mit Leiterschienen

					LA	TM			
43	44	4	LLIRS431	102	+37	+25	0,016	5,6	2
86	44	4	LLIRS861	138	+74	+31	0,028	10,0	2

W	D	H	CODE	PTS	OPTIONS (PTS)	CBM	KGS	PARCELS
L	P	H	REF.		OPTIONS (PTS)	MC	KG	COLIS
B	T	H	ART. NR.		VARIANTEN (PTS)	M ³	KG	KOLLI



Shelf supplied with metal rails for using with our hook-on ladder, rails on both sides
Étagère avec intégration pour échelle sur 2 côtés
Einlegeböden T.39 Melamin

					LA	TM				
	43	44	4	LLIRS432	130	+37	+49	0,016	5,6	2
	86	44	4	LLIRS862	176	+74	+60	0,028	10,0	2



Hook-on metal ladder
Échelle pour libreria H.256 cm
Metall Leiter

					TM					
	33	39	199	LLISC000	459	+305		0,075	11,0	1

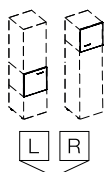

Melamine hinged door - non-locking
Porte en mélamine sans serrure
Melamintür ohne Schloß

					LA	4	AC				
L	43	2	45	LLIALRS0	58	+45	+20	+214	0,013	3,0	1
R	43	2	45	LLIALRD0	58	+45	+20	+214	0,013	3,0	1

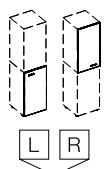

Melamine hinged door - non-locking
Porte en mélamine sans serrure
Melamintür ohne Schloß

					LA	4	AC				
L	43	1,8	83	LLIAL121	77	+87	+20	+234	0,023	4,6	1
R	43	1,8	83	LLIAL122	77	+87	+20	+234	0,023	4,6	1

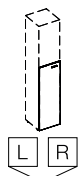

Melamine hinged door - non-locking
Porte en mélamine sans serrure
Melamintür ohne Schloß

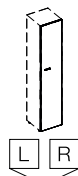

					LA	4	AC				
L	43	1,8	128	LLIAL123	104	+136	+20	+278	0,034	7,1	1
R	43	1,8	128	LLIAL124	104	+136	+20	+278	0,034	7,1	1

Please note: it may not be fitted on 2560mm high Libreria
Pas possible dans la Libreria H. 256 cm comme superposition
Es ist nicht möglich auf Modulen H.256 cm zu überlagern

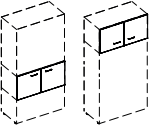
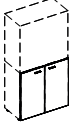

Melamine hinged door - non-locking
Porte en mélamine sans serrure
Melamintür ohne Schloß

					LA	4	AC				
L	43	1,8	211	LLIAL125	144	+223	+31	+399	0,054	11,6	1
R	43	1,8	211	LLIAL126	144	+223	+31	+399	0,054	11,6	1

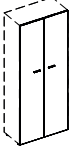
	W	D	H	CODE	PTS	OPTIONS (PTS)	CBM	KGS	PARCELS		
	L	P	H	REF.		OPTIONS (PTS)	MC	KG	COLIS		
	B	T	H	ART. NR.		VARIANTEN (PTS)	M ³	KG	KOLLI		
	Melamine double hinged doors - non-locking Jeu de 2 portes en mélamine sans serrure Melamintüren ohne Schloß					LA +87	4 +31	AC +435	0,015	5,3	1
	86	2	45	LLIALDRI	84						
	Melamine double hinged doors - non-locking Jeu de 2 portes en mélamine sans serrure Melamintüren ohne Schloß					LA +177	4 +31	AC +478	0,028	9,1	1
	86	1,8	83	LLIAL127	119						
	Melamine double hinged doors - non-locking Jeu de 2 portes en mélamine sans serrure Melamintüren ohne Schloß					LA +262	4 +31	AC +572	0,040	13,9	1
	86	1,8	128	LLIAL128	158						
<small>Please note: it may not be fitted on 2560mm high Libreria Pas possible dans la Libreria H. 256 cm comme superposition Es ist nicht möglich auf Modulen H.256 cm zu überlagern</small>											
	Melamine double hinged doors - non-locking Jeu de 2 portes en mélamine sans serrure Melamintüren ohne Schloß					LA +447	4 +43	AC +826	0,066	22,8	1
	86	1,8	211	LLIAL129	223						



4 = Soft close / Fermeture Soft / Soft Verschießung

AC = Leather doors / Portes en cuir / Türen aus Leder

L = Polished chrome frame / Cadre brillant / Rahmen Chrom-Effekt

LA = Lacquered / Laqué / Lackiert

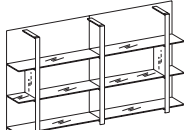
TM = Gold (OR), Bronze (BR) or Corten (CR) frame / Cadre Or (OR), Bronze (BR) ou Corten (CR) / Gestell in Gold (OR), Bronze (BR) oder Kupfer (CO)

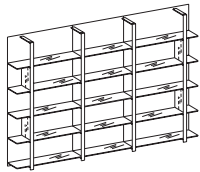
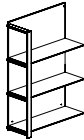
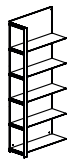
	W	D	H	CODE	PTS	OPTIONS (PTS)	CBM	KGS	PARCELS	
	L	P	H	REF.		OPTIONS (PTS)	MC	KG	COLIS	
	B	T	H	ART. NR.		VARIANTEN (PTS)	M ³	KG	KOLLI	
	Boiserie configuration - two sections Composition Boiserie en 2 modules Wandkombination 2 Elemente									
	235	36	135	LBOM0023	2200	L +211	LA +618	TM +546	0,264	117,5
	Includes two MFC side panels N. 2 côtés de fermeture inclus Inkl. 2 Aussenseiten									
	Boiserie configuration - three sections Composition Boiserie en 3 modules Wandkombination 3 Elemente									
	327	36	135	LBOM0032	3120	L +280	LA +835	TM +727	0,397	167,5
	Includes two MFC side panels N. 2 côtés de fermeture inclus Inkl. 2 Aussenseiten									
	Boiserie configuration - two sections Composition Boiserie en 2 modules Wandkombination 2 Elemente									
	235	36	219	LBOS0023	3423	L +285	LA +1028	TM +734	0,435	189,9
	Includes four MFC side panels N. 4 côtés de fermeture inclus Inkl. 4 Aussenseiten									
	Boiserie configuration - three sections Composition Boiserie en 3 modules Wandkombination 3 Elemente									
	327	36	219	LBOS0032	4844	L +384	LA +1381	TM +978	0,648	271,2
	Includes four MFC side panels N. 4 côtés de fermeture inclus Inkl. 4 Aussenseiten									
	Middle low section, use as an add-on to extend above configurations Module mi-hauteur centrale "Add-on" Folgenmodul für Boiserie H.135									
	92	36	135	LBOM0031	917	L +71	LA +218	TM +182	0,133	67,0
	Middle high section, use as an add-on to extend above configurations Module haute centrale "Add-on" Folgenmodul für Boiserie H.219									
	92	36	219	LBOS0031	1420	L +95	LA +356	TM +245	0,213	109,9

LA = Lacquered / Laqué / Lackiert

L = Polished chrome frame / Cadre brillant / Rahmen Chrom-Effekt

TM = Gold (OR), Bronze (BR) or Corten (CR) frame / Cadre Or (OR), Bronze (BR) ou Corten (CR) / Gestell in Gold (OR), Bronze (BR) oder Kupfer (CO)

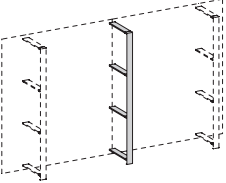
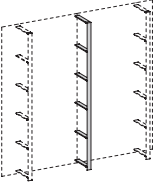
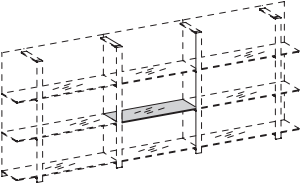
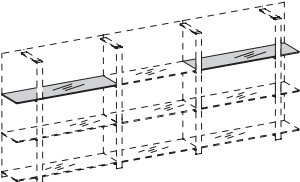
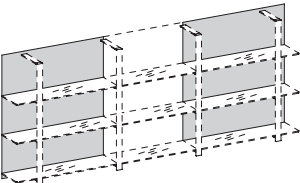
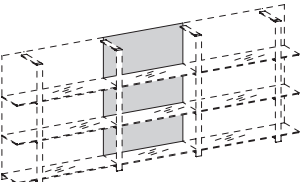
	W	D	H	CODE	PTS	OPTIONS (PTS)	CBM	KGS	PARCELS	
	L	P	H	REF.		OPTIONS (PTS)	MC	KG	COLIS	
	B	T	H	ART. NR.		VARIANTEN (PTS)	M ³	KG	KOLLI	
	<p>Upright with 4 beams Montant pour Boiserie, avec 4 traverses Stollen mit 4 Traversen</p>									
	6	3,5	131	LBOMM001	244	L +71 TM +182	0,013	2,5	1	
	<p>Upright with 6 beams Montant pour Boiserie, avec 6 traverses Stollen mit 6 Traversen</p>									
	6	3,5	215	LBOMS001	341	L +95 TM +245	0,022	3,3	1	
	<p>Middle glass shelf Etagère centrale en verre, pour Boiserie Mittlerer Fachböden aus Glas</p>									
	92	31,5	1	LBORC001	179		0,021	10,0	1	
	<p>Pair of end glass shelves Jeu de 2 étagères terminales en verre, pour Boiserie 2 äußere Fachböden aus Glas</p>									
	118	31,5	1	LBORT002	372		0,027	22,0	1	
	<p>Pair of melamine end back panels Jeu de 2 fonds terminaux pour Boiserie Paar äußere Rückwände</p>									
	118	1,8	135	LBOSMT00	357	LA +557	0,144	44,0	2	
	<p>Melamine middle back panel Fond central Mittlere Rückwand</p>									
	92	1,8	135	LBOSMC00	158	LA +218	0,057	17,5	1	

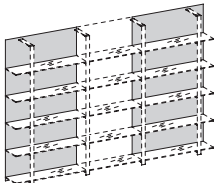
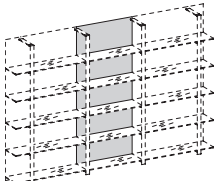
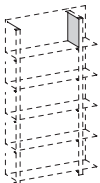
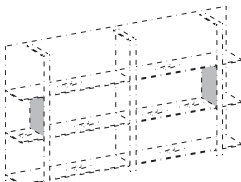
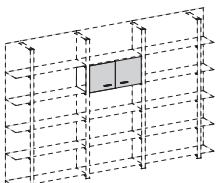
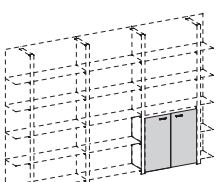
	W	D	H	CODE	PTS	OPTIONS (PTS)	CBM	KGS	PARCELS	
	L	P	H	REF.		OPTIONS (PTS)	MC	KG	COLIS	
	B	T	H	ART. NR.		VARIANTEN (PTS)	M ³	KG	KOLLI	
	Pair of melamine end back panels Jeu de 2 fonds terminaux pour Boiserie Paar äußere Rückwände									
	118	1,8	219	LBOST00	511	LA +909	0,234	70,0	2	
	Melamine middle back panel Fond central Mittlere Rückwand									
	92	1,8	219	LBOSSC00	215	LA +356	0,086	28,0	1	
	Side panel Panneau de côté pour boiserie Aussenseite 1 Stück, Unterstützung für Boiserie									
	32	0,8	39	LBOFIF1	30	LA +30	0,800	0,0	1	
	Pair of side panels Jeu de deux panneaux de côtés pour boiserie Paar Aussenseite									
	32	0,8	39	LBOFIFI2	51	LA +60	1,600	0,0	1	
	Melamine 450mm high double hinged doors - non-locking Jeu de 2 portes en mélamine pour boiserie, h. 45 cm, sans serrure Melamintüren 10H ohne Schloß									
	86	1,8	45	LBOALDRI	183	LA 4 AC +87 +31 +435	0,019	7,2	3	
	Please add two side panels. These doors may be fitted to any position to the front of the Boiserie. Rajouter n°2 côtés de fermeture 2 Aussenseiten									
	Melamine 830mm high double hinged doors - non-locking Jeu de 2 portes en mélamine pour boiserie, h. 83 cm, sans serrure Melamintüren 20H ohne Schloß									
	86	1,8	83	LBOALDBD	281	LA 4 AC +177 +31 +570	0,034	10,6	3	
	Please add four side panels. These doors may be fitted to the lower end of the Boiserie only as shown Rajouter n°4 côtés de fermeture 4 Aussenseiten									

W	D	H	CODE		OPTIONS (PTS)	CBM	KGS	PARCELS
L	P	H	REF.	PTS	OPTIONS (PTS)	MC	KG	COLIS
B	T	H	ART. NR.		VARIANTEN (PTS)	M ³	KG	KOLLI

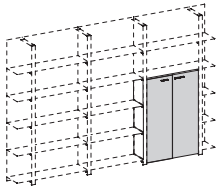

Melamine 1270mm high double hinged doors - non-locking

Jeu de 2 portes en mélamine pour boiserie, h. 127 cm, sans serrure

Melamintüren 30H ohne Schloß

86	1,8	127	LBOALDMD	321	LA +271	4 +31	AC +669	0,045	15,4	3
----	-----	-----	----------	-----	------------	----------	------------	-------	------	---

Please add six side panels. These doors may be fitted to the lower end of the Boiserie only as shown
Rajouter n°6 côtés de fermeture
6 Aussenseiten

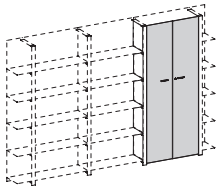

Melamine 2110mm high double hinged doors - non-locking

Jeu de 2 portes en mélamine pour boiserie, h. 211 cm, sans serrure

Melamintüren 50H ohne Schloß

86	1,8	211	LBOALDSD	414	LA +448	4 +43	AC +921	0,073	24,3	3
----	-----	-----	----------	-----	------------	----------	------------	-------	------	---

Please add ten side panels and one glass top
Rajouter n°10 côtés de fermeture + 1 étagère
10 Aussenseiten und 1 Fachböden hinzufügen

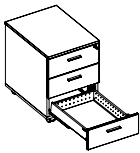

3-drawer melamine mobile pedestal with Zen metal handles

Caisson mobile 3 tiroirs à extraction totale avec système anti-basculement

Rollcontainer 3 Metall Schubladen mit Vollauszug und antikippssystem, Metallgriffe

42	56	58	L08CA003	632	LA +280			0,159	26,1	2
----	----	----	----------	-----	------------	--	--	-------	------	---

Full extension metal drawer boxes with soft close and anti-tilt, lockable castors
Tiroirs en métal à extraction totale, fermeture "soft" et anti-basculement, roulettes avec système de blocage
Metallschubladen mit Vollauszug und antikippssystem, Soft-System, Rollen mit Bremse

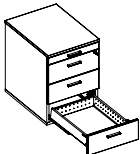

3-drawer melamine mobile pedestal with pen drawer, with Zen metal handles

Caisson mobile 3 tiroirs + tirette à extraction totale avec système anti-basculement

Rollcontainer 3 Metall Schubladen mit Vollauszug und antikippssystem + 1 Schreibstiftablage, Metallgriffe

42	56	58,5	L08CAC03	604	LA +304			0,177	27,1	2
----	----	------	----------	-----	------------	--	--	-------	------	---

Full extension metal drawer boxes with soft close and anti-tilt
Tiroirs en métal à extraction totale, fermeture "soft" et anti-basculement
Metallschubladen mit Vollauszug und Antikippssystem, Soft-System

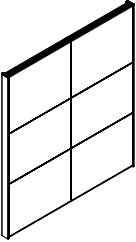
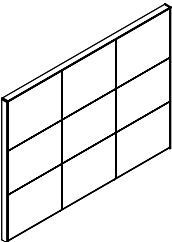
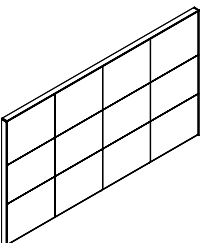
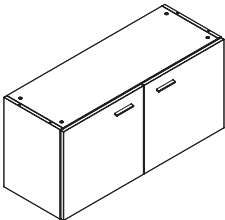
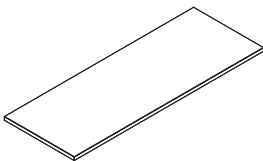
	CODE REF. ATR. NR.	PTS	OPTIONS (PTS) OPTIONS (PTS) VARIANTEN (PTS)
	Boiserie wall paneling W. 203 - H 227 cm Boiserie cloison L. 203 - H 227 cm <i>Wandboiserie B.203 - H 227cm</i>		
	203 PRHFB101	2108	PG L W +93 +690 +2276
	Boiserie wall paneling W. 303cm - H 227 cm Boiserie cloison L 303 cm - H 227 cm <i>Wandboiserie B.303cm - H 227 cm</i>		
	303 PRHFB102	2872	PG L W +108 +1035 +3413
	Boiserie wall paneling W. 403cm - H 227 cm Boiserie cloison L 403 cm - H 227 cm <i>Wandboiserie B.403cm - H 227 cm</i>		
	403 PRHFB103	3634	PG L W +122 +1381 +4553
	Suspended unit with 2 doors for wall with one internal shelf, without lock Meuble suspendu 2 portes pour cloison avec une étagère interne, sans serrure <i>Hängeschränk mit 2 Türen für Wand mit Innenfachboden, ohne Schloss</i>		
	100 PDBOM001	363	L W +477 +1409
	100Wx37Dx50H cm. Carcass available in white or silver.		
	Upper finishing top for suspended unit, incl. support beam Plan de finition supérieur pour meuble suspendu, support inclus <i>Obere Abdeckplatte für hängenden Schränk inklusive Stützbalken</i>		
	100 PDBOT001	253	L W +88 +224
	200 PDBOT002	288	+176 +442

L = Lacquered / Laqué / Lackiert

PG = Tracks in powder coated anthracite / Profils gris ombre / Profile Dunkelgrau

W = Wood veneer / Placage bois / Holz furniert

	CODE	PTS	OPTIONS (PTS)
	REF.		OPTIONS (PTS)
	ATR. NR.		VARIANTEN (PTS)

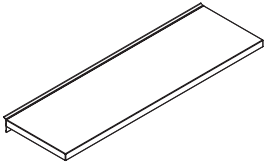

Panel shelf for boiserie
 Etagère panneau pour boiserie
 Borde für Systemwandplatte

			L	W
50	PDH1X141	70	+36	+98
100	PDH1X142	138	+72	+186

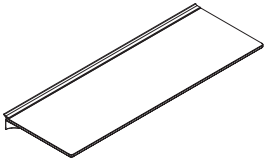

Satin glass shelf for boiserie
 Etagère en verre satiné pour boiserie
 Borde aus satiniertes Glas für Systemwand

100	PDH1X152	242
-----	----------	-----

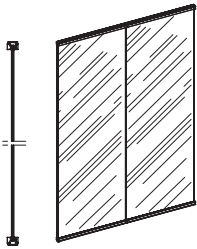

Glass section standard laminated 5+5.1 M3 55x40mm (Remarks: max H.3050mm)
 Section vitrée standard stratifié 5+5.1 M3 55x40mm (NB: hauteur max 3050mm)
 Abschnitt standard Schichtverglasung 5+5.1 M3 55x40mm (Hinweis: maximale Höhe 3050mm)

			V2	PG	PV	PL
ML	PMM3HM01	779	+122	+10	+36	+95



Starting profile M3 55x40mm
 Profil de départ M3 55x40mm
 Anfangsprofil M3 55x40mm

	PMM3ND01	232	PG	PV	PL
			+59	+204	+473



90° simple junction M3 55x40mm
 Jonction 90° simple M3 55x40mm
 Einfache 90°-Verbindung M3 55x40mm

	PMM3ND02	195
--	----------	-----

L = Lacquered / Laqué / Lackiert
 PG = Tracks in powder coated anthracite / Profils gris ombre / Profile Dunkelgrau
 PL = Veneered aluminium tracks / Profils recouverts en placage bois
 PV = Tracks lacquered in the RAL colour of your choice, or Gold, Bronze, Corten / Profils RAL au choix ou Or (OR), Bronze (BR) ou Corten (CR) / Profile nach RAL Farbkarte oder Gold (OR), Bronze (BR) oder Kupfer (CO)
 V2 = Frosted glass / Verre dépoli / Satiniertes Glas
 W = Wood veneer / Placage bois / Holz furniert
 ML = Price per linear meter / Prix au mètre linéaire / Preis pro Laufmeter

CODE REF. ATR. NR.	PTS	OPTIONS (PTS) OPTIONS (PTS) VARIANTEN (PTS)
--------------------------	-----	---

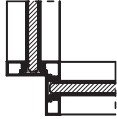

90° junction with profile M3 55×40mm
 Jonction 90° con profilo M3 55×40mm
 90°-Verbindung mit Profil M3 55×40mm

PMM3ND03 196

PG PV
 +34 +101



Single framed glass door L.1000 M3 55×40mm
 Porte simple encadrée vitrée L.1000 M3 55×40mm
 Einzelne Glasrahmentür L.1000 M3 55×40mm

				V2	PG	PV
DH	100	PMM3TE01	2057	+213	+165	+479
DA	100	PMM3TE02	2031	+213	+165	+479
SH	100	PMM3TE03	2057	+213	+165	+479
SA	100	PMM3TE04	2031	+213	+165	+479

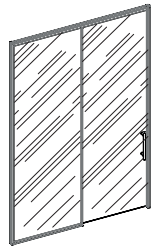

Single glass sliding door RH L.2000 (bar handle 400mm without lock) M3 55×40mm
 Porte simple vitrée coulissante D L.2000 (poignée de 400mm sans serrure) M3 55×40mm
 Einzelne Glasschiebetür RE L.2000 (lange Griff 400mm ohne Schloss) M3 55×40mm

				V2	PG	PV
	200	PMM3PS21	2663	+423	+139	+453

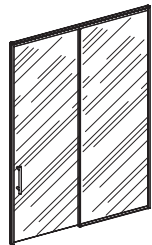

Single glass sliding door LH L.2000 (bar handle 400mm without lock) M3 55×40mm
 Porte simple vitrée coulissante G L.2000 (poignée de 400mm sans serrure) M3 55×40mm
 Einzelne Glasschiebetür LI L.2000 (lange Griff 400mm ohne Schloss) M3 55×40mm

				V2	PG	PV
	200	PMM3PS22	2663	+423	+139	+453

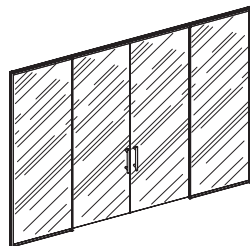



Double glass sliding door L.4000 (bar handle 400mm without lock) M3 55×40mm
 Porte double vitrée coulissante L.4000 (poignée de 400mm sans serrure) M3 55×40mm
 Doppelte Glasschiebetür L.4000 (lange Griff 400mm ohne Schloss) M3 55×40mm

				V2	PG	PV
	400	PMM3PS23	4844	+866	+211	+705

PG = Tracks in powder coated anthracite / Profils gris ombre / Profile Dunkelgrau
 PV = Tracks lacquered in the RAL colour of your choice, or Gold, Bronze, Corten / Profils RAL au choix ou Or (OR), Bronze (BR) ou Corten (CR) / Profile nach RAL Farbkarte oder Gold (OR), Bronze (BR) oder Kupfer (CO)
 V2 = Frosted glass / Verre dépoli / Satiniertes Glas
 DA = Door with AGB handle/lock, opens pulling to the right / Porte tirant droite, poignée AGB / Mittiger rechten Tür Griff AGB
 DH = Door with HCS handle/lock, opens pulling to the right / Porte tirant droite, poignée HCS / Mittiger rechten Tür Griff HCS

SA = Door with AGB handle/lock, opens pulling to the left / Porte tirant gauche, poignée AGB / Mittiger linken Tür Griff AGB
 SH = Door with HCS handle/lock, opens pulling to the left / Porte tirant gauche, poignée HCS / Mittiger linken Tür Griff HCS

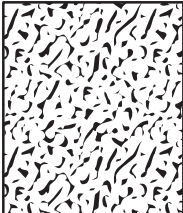
	CODE REF. ATR. NR.	PTS	OPTIONS (PTS) OPTIONS (PTS) VARIANTEN (PTS)
	Technical module to house lights M3 55×40mm Module technique avec spot lumière M3 55×40mm <i>Technikmodul mit Lichtanschluss M3 55×40mm</i>		PG PV PL +267 +311 +880
	PMM3ND09	801	
	Technical module to house lights and sockets M3 55×40mm Module technique avec spot lumière et prises M3 55×40mm <i>Technikmodul mit Licht- und Steckdosenanschluss M3 55×40mm</i>		PG PV PL +267 +311 +880
	PMM3ND10	822	
	Neutral technical module M3 100×40mm W.200 Module technique plein neutre M3 100×40mm L.200 <i>Neutrales Technikmodul M3 100×40mm B.200</i>		PG PV PL +267 +311 +880
	PMM3ND12	666	
	"Canvas Champagne Gold" / "Weave Pearl Dark" / "Vega" glass finish film Film décoratif "Canvas Champagne Gold" / "Weave Pearl Dark" / "Vega" <i>Dekorative Folie "Canvas Champagne Gold" / "Weave Pearl Dark" / "Vega"</i>		
	MQ	PMMX0015	414

PG = Tracks in powder coated anthracite / Profils gris ombre / Profile Dunkelgrau

PL = Veneered aluminium tracks / Profils recouverts en placage bois

PV = Tracks lacquered in the RAL colour of your choice, or Gold, Bronze, Corten / Profils RAL au choix ou Or (OR), Bronze (BR) ou Corten (CR) / Profile nach RAL Farbkarte oder Gold (OR), Bronze (BR) oder Kupfer (CO)

MQ = Price per square meter / Prix au mètre carré / Preis pro Quadratmeter

Product Design
Quadrifoglio Group R&D Dept.

Project Direction & Coordination
Quadrifoglio Group Marketing & Communication Dept.

Rev.02-2023

Quadrifoglio Sistemi d'Arredo S.p.A.
via Cornarè, 12 - 31040 Mansuè (TV) - Italy
T. +39 0422 756025 - info@quadrifoglio.com
www.quadrifoglio.com



Technical and aesthetical details, finishes or other product features can be modified without notification.
Particolari tecnici, estetici, finiture o altro possono essere modificati senza preavviso.

