



Quadrifoglio Group



Office & Meeting Chairs

Quadrifoglio Group. Living and breathing design, everywhere

We are Ethics and Vision in the form of Order and Ergonomics.

Design Office, Living and Lighting. Three ways of exploring design, united by the quality of the materials, the quest for elaborate finishes and the continuous focus on comfort and wellbeing, as part of an all-Italian identity.

Quadrifoglio Group,
vivere il design, ovunque

**Siamo Etica e Visione declinate
in Ordine ed Ergonomia.**

Design Office, Living e Lighting. Tre modi di coniugare il design, accomunati dalla qualità dei materiali, dalla ricerca di finiture elaborate e dalla tensione continua al comfort e al benessere, nel segno di un'identità tutta italiana.



Our Identity

Strong values, dynamic thinking

Over the years we have seen the world change. Technological, social and cultural innovations, together with climate change, are transforming our lives and the way we inhabit our spaces. The office, the home, public and private spaces are now hybrid environments that demand new design approaches.

In response to these ongoing changes the Quadrifoglio Group has made a pledge: to make design sustainable in order to improve our quality of life. A sense of ethics that pervades all of its actions. From the careful selection of top-quality raw materials through to the expert choice of the most evocative finishes, from the manual actions of its designers, who sketch out their initial ideas on a piece of paper, through to those of the machinery which sculpts it from the material with pinpoint precision.

Quadrifoglio Group, since 1991.

La nostra Identità

Valori fermi, pensiero dinamico

Nel corso degli anni, abbiamo visto cambiare il mondo. Le innovazioni tecnologiche, sociali e culturali e i cambiamenti climatici stanno trasformando la nostra vita e il modo in cui abitiamo gli spazi. L'ufficio, la casa, i luoghi pubblici e privati sono ormai ibridi e impongono nuove vie di pensiero alla progettazione.

In Quadrifoglio Group interpretiamo questi incessanti mutamenti attraverso un unico impegno: rendere sostenibile il design, per aumentare la qualità della vita. Un rigore etico che pervade ogni gesto. Dalla selezione accurata delle materie prime di assoluta qualità, fino alla scelta sapiente delle finiture più evocative, dal movimento delle mani dei designer, che tracciano su un foglio la prima manifestazione di un'idea, fino a quello del macchinario che con accuratezza millimetrica la scolpisce nella materia.

Quadrifoglio Group, dal 1991.







People and relations

Thoughts, ideas, intuition

There would be no places without the people that live there. There would be no design without ideas. There would be no Quadrifoglio Group without our workers, customers and partners.

At the Quadrifoglio Group every project stems from and for interpersonal relations; from the sharing of an idea by designers to the production of ergonomic furniture and through to the design of comfortable spaces perfect for personal interaction. We choose our partners on the basis of shared values. We share with all employees a style of work based on order, both exterior and interior. During the year we dedicate time to training in order to share knowledge and enrich our perspective. Social commitment, company welfare and the protection of personal safety: this is how we put our people at the centre.

Quadrifoglio Group, people first and foremost.

Persone e relazioni

Pensieri, idee, intuizioni

Non esisterebbero i luoghi senza le persone che li vivono. Non esisterebbe il design senza un'intuizione tra le mani. Non esisteremmo noi, senza i nostri collaboratori, clienti e partner.

In Quadrifoglio Group ogni progetto nasce dall'incontro e per l'incontro tra le persone. Da quando un'idea viene condivisa dai designer, alla produzione di arredi ergonomici, fino alla progettazione di ambienti confortevoli, dove abitare le relazioni. Selezioniamo i nostri partner sulla base di valori comuni. Condividiamo uno stile di lavoro improntato all'ordine, esteriore e interiore, con tutti i dipendenti. Dedichiamo del tempo durante tutto l'anno alla formazione, per contaminare i saperi e arricchire la nostra prospettiva. Impegno sociale, welfare aziendale e tutela della sicurezza: ecco come mettiamo le persone al centro.

Quadrifoglio Group, siamo prima di tutto persone.



Our commitment

Sustainability is an everyday action

Sustainability is awareness, vision, transformation. It is the ability to construct the future by taking action in the present, also by changing little things.

At the Quadrifoglio Group we work every day to ensure that Sustainability becomes pervasive: a way of thinking, working and living, to feel good today and even better tomorrow. An ethical value, to share collectively but also to practice individually. Our focus on improving company processes, with respect for the environment, is constant. From the streamlining of production to the attainment of international green certificates, from company welfare policies through to the creation of an open roundtable with our team dedicated to sustainability, in order to share goals and strategies. This is our commitment.

Quadrifoglio Group, informed ethics.

Il nostro impegno

La Sostenibilità è un atto quotidiano

La Sostenibilità è consapevolezza, visione, trasformazione. È la capacità di costruire il futuro agendo nel presente, anche attraverso piccoli gesti.

In Quadrifoglio Group ci impegniamo ogni giorno affinché la Sostenibilità diventi pervasiva: un modo di pensare, di lavorare e di vivere, per stare bene oggi e meglio domani. Un valore etico, da condividere collettivamente e da praticare anche individualmente. La nostra tensione verso il miglioramento dei processi aziendali, nel rispetto dell'ambiente, è costante. Dalla razionalizzazione della produzione, all'ottenimento delle certificazioni green internazionali, dalle politiche di welfare aziendale, fino alla creazione di un tavolo aperto con il nostro team dedicato alla sostenibilità, per condividere obiettivi e strategie. Questo è il nostro impegno.

Quadrifoglio Group, etica consapevole.



The mark of responsible forestry

Look for our FSC™-certified products





Klavertje vier, Trèfle à quatre feuilles, Four-leaf clover, четырёхлистный клевер

An international empathy

In all languages and cultures, Made in Italy is synonymous with quality raw materials, attention to detail and elegance. We export our exclusive and universally-recognised approach and method to Europe and the rest of the world.

At the Quadrifoglio Group Made in Italy means being in touch with the needs of the present: familiarity with different cultures, understanding people's needs and designing solutions tailored to future habits. We speak the language of the foreign markets through an international style and, thanks to our sales and marketing departments, we communicate with our customers in their own languages because making people feel part of a family is the absolute epitome of care and professionalism in our opinion.

Quadrifoglio Group, Italy. World.

Klavertje vier, Trèfle à quatre feuilles, Four-leaf clover, четырёхлистный клевер

Un'empatia internazionale

In tutte le lingue e le culture, Made in Italy è sinonimo di qualità delle materie prime, attenzione ai dettagli ed eleganza. Esportiamo in Europa e in tutto il mondo un modo di essere e di fare esclusivo, riconosciuto universalmente.

VIII

In Quadrifoglio Group Made in Italy significa essere in ascolto delle necessità del presente: conoscere diverse culture, comprendere le esigenze delle persone e disegnare soluzioni a misura delle abitudini che verranno. Parliamo il linguaggio dei mercati esteri attraverso uno stile internazionale e, grazie ai nostri dipartimenti, commerciale e marketing, comunichiamo con i clienti nelle loro lingue madri, perché far sentire le persone come in famiglia per noi è la massima espressione di cura e professionalità.

Quadrifoglio Group, Italia. Mondo.



Index

02-141

OFFICE CHAIRS

DIRECTA / DUNE / DIVA SOFT / DIÈSIS / DINAMICA / DEKORA / DIADE
DIADE ROCK / ODE / OXYGEN / OMNIA / OKAY

142-191

MEETING CHAIRS

CITY / COVE / CLUE / CLOUD / CLOSE / C-STOOL



Executive Chairs Index



DIRECTA

04 | 15

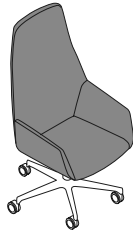

DUNE

16 | 25



DIVA SOFT

26 | 37



DIÈSIS

38 | 51



DINAMICA

52 | 65



DEKORA

66 | 73



DIADE

74 | 85

Task Chairs Index



DIADE ROCK

86 | 97



ODE

98 | 111



OXYGEN

112 | 123



OMNIA

124 | 131



OKAY

132 | 141



DIRECTA

designed by Dorigo Design

**Destined for excellence.
Directa is an icon of
Italian design featuring
an authoritative style
and fine materials; it is
available in two versions:
high or low-backed.**

Direzione: eccellenza.

Directa è un'icona Made in Italy: stile autorevole,
materiali pregiati e due versioni disponibili, con
schienale alto o basso.





DIRECTA executive chair | P01/098 leather
GRACE floor lamp | Natural linen shade and Black base
X10 desk | Ebony top and legs



DIRECTA executive chair | P01/092 leather and Ebony backrest
X9 meeting table | Ebony top with Black leather inlay, Umbra Grey legs
OLA FLY pendant lamp | White fibreglass shade

Office & Meeting Chairs



The soft shape of the continuous aluminium armrest exudes a distinctive personality. It can be covered in leather, to match the inner back and seat finishings.

Il bracciolo continuo in alluminio racchiude nella sua forma morbida uno slancio di personalità. È rivestibile in pelle per abbinarlo alle finiture dello schienale interno e della seduta.



DIRECTA executive chair | P01/096 leather and I01/516 fabric
AFRA table lamp | Matt White acid-etched glass shade and Black base
X10 desk | American Walnut top and legs
P1 wall cladding | American Walnut



**Comfort seamlessly converges
with elegance in the Directa
tall-backed version with headrest:
a stylish detail and ergonomic
cervical support, for superior
well-being when at work.**

La comodità è unita in modo indissolubile all'eleganza
nella versione di Directa con schienale alto e
poggiatesta: un dettaglio di stile e un sostegno
ergonomico per la parte cervicale, per un benessere
lavorativo superiore.





DIRECTA executive chair | P01/095 leather and American Walnut backrest
X9 meeting table | Umbra Grey legs, American Walnut top with Brown leather inlay
PIPES pendant lamp | Gold

DESIGN OFFICE



The outer part of the back can be finished in veneered wood and matched with the finishing of the desk and other executive furnishing elements, to convey a sense of aesthetic solidity and visionary elegance.

Il retro dello schienale può essere rifinito in legno impiallacciato, abbinabile con la finitura della scrivania e degli altri mobili direzionali, per comunicare solidità estetica ed eleganza visionaria.



DIRECTA executive chair | D02/326 fabric
e-10 desk | Grey White lacquered legs and Elm top
BABEL floor lamp | White shade and base
FLY pendant lamp | Matt White



DESIGN OFFICE



designed by Dorigo Design

**Reception in style.
Comfort, softness and
shape: Dune is the
executive seat with an
enveloping upholstery.**

**Accogliere, con stile.
Comodità, morbidezza e forma: si parla di Dune,
la seduta direzionale con un'imbottitura avvolgente.**



DUNE executive chair | P01/172 leather
X7 desk | Matt White glass top and Matt White legs
AFRA floor lamp | Matt White acid-etched glass shade and Black base





Dune is available with high-backed with headrest, high or low backed: provide impeccable comfort, making it the natural addition to any desk or meeting table.

Dune è disponibile con schienale alto con poggiatesta, alto o basso: mantiene immutato il suo comfort e diventa il naturale completamento di una scrivania o di un tavolo riunioni.





DUNE executive chair | P01/257 leather
X8 meeting table | Eucalyptus top and Umbra Grey legs
BOISERIE | Eucalyptus back and Umbra Grey lacquered doors
ESCAPE pendant lamp | Matt White



The soft style of the seat takes centre stage in any setting: materials, finishings and colours are customisable, enhancing shared and executive interiors. Welcoming and welcomed: this is what you feel when you sit on Dune.

Lo stile morbido della seduta pervade lo spazio: materiali, finiture e colori sono personalizzabili per valorizzare ambienti condivisi e direzionali. Accogliere e sentirsi accolti è ciò che si prova a sedersi su Dune.

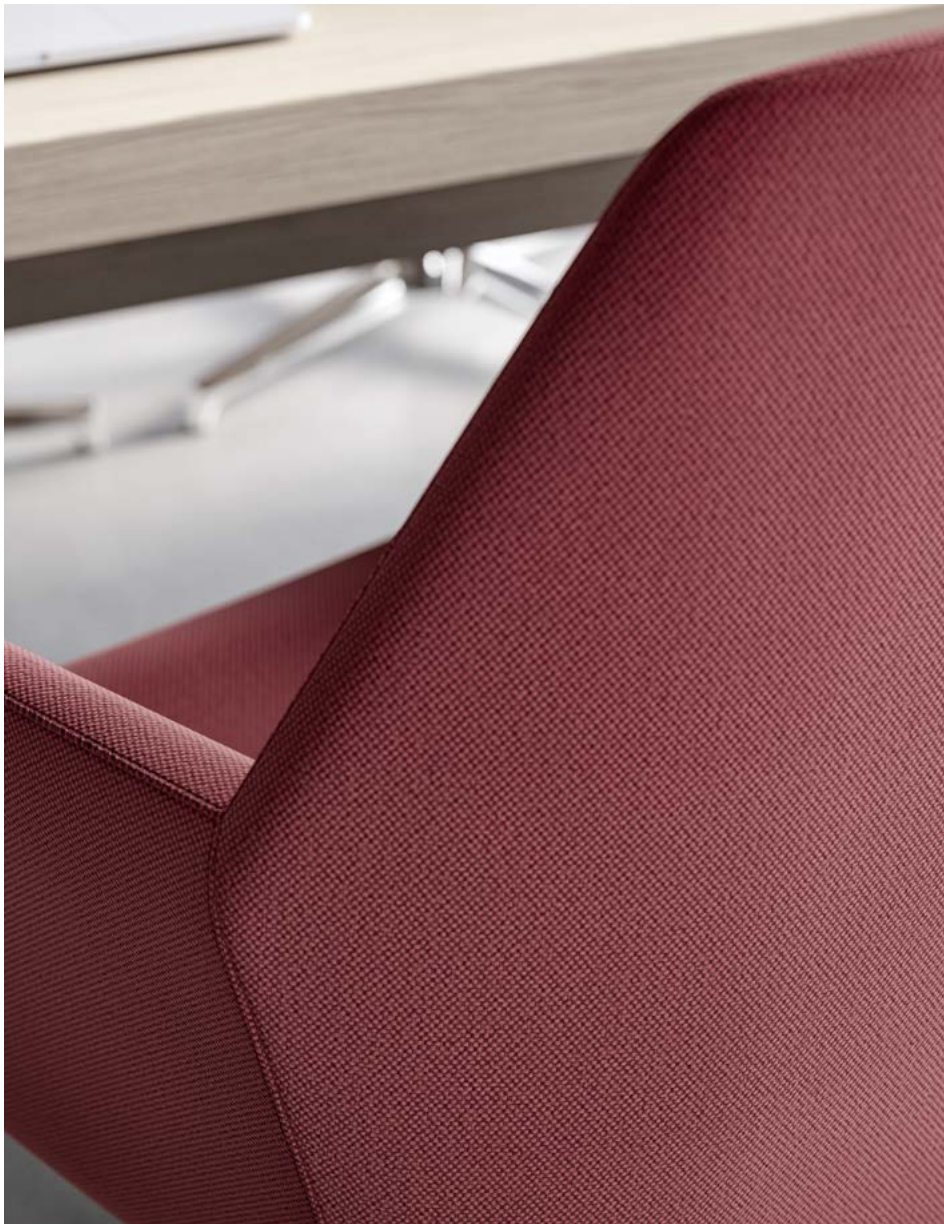





DUNE executive chair | D02/278 fabric
BLONDE pendant lamp | Brushed aluminium
LIBRERIA bookshelves | Umbra Grey laquer
X8 meeting table | Canaletto Walnut top and Umbra Grey legs



designed by Quadrifoglio Group

**The tenth muse.
Diva Soft is sheer allure:
the executive seat
featuring a classic look
and a modern spirit, with
a chrome steel structure.**

**La decima musa.
Diva Soft è la misura del fascino: la seduta
direzionale dall'aspetto classico e dallo spirito
moderno, con la struttura in acciaio cromato.**



DIVA SOFT executive chair | D02/272 fabric
X6 desk | Matt White legs and Invisible White porcelain stoneware top
BOISERIE | Silk Grey lacquered back and White lacquered doors
AFRA pendant lamp | Matt White acid-etched glass shade





The sled base version of Diva Soft seat is a formal and elegant solution, ideal for meeting rooms; the 5-star base version with wheels is designed for executive use.

La seduta Diva Soft nella versione a slitta, si presenta formale ed elegante, ideale per sale riunioni, oppure con la base a 5 razze con ruote per gli usi direzionali.





DIVA SOFT executive chair | P01/092 leather
X9 meeting table | Ebony top and Umbra Grey legs
GRACE pendant lamp | Natural linen shade



DIVA SOFT executive chair | P01/296 leather
X9 desk | American Walnut top and Umbra Grey legs
HALF MOON table lamp | Black fabric shade and Black base





Rigorous and linear armrests with chrome steel finishing add a touch of light, exalting and reflecting seat colours to enhance the personality of Diva Soft in interiors.

I braccioli con finitura in acciaio cromato, rigorosi e lineari, sono un tocco di luce: esaltano e riflettono i colori della seduta, amplificando la personalità di Diva Soft negli ambienti.



DIVA SOFT executive chair | D02/270 fabric
X5 meeting table | Elm top and Umbra Grey legs
P1 wall cladding | Elm panels and Umbra Grey lacquered floating elements



Armrests can be covered in leather, for a softer and more sumptuous matt effect. A distinctive caress in contact with your hands.

I braccioli sono rivestibili in pelle, per un effetto opaco, più morbido e sontuoso. Una carezza distinta a contatto con le mani.



DIVA SOFT executive chair | P01/172 leather
X10 meeting table | American Walnut with Anthracite leather inlay
BLONDE pendant lamp | Black

DESIGN OFFICE





designed by Dorigo Design

**A light symphony.
Dièsis is a refined and
sinuous executive seat
that exudes an essential
personality and features
an environmentally
friendly design.**

**Sinfonia leggera.
Dièsis è una sedia direzionale raffinata
e sinuosa, dalla personalità essenziale,
progettata nel rispetto dell'ambiente.**



DIÈSIS executive chair | P01/096 leather and Black frame
X8 desk | Canaletto Walnut top and Umbra Grey legs
GRACE table lamp | Black fabric shade and Black base





Dièsis is available in three versions: tall with a headrest, low with a swivel base, and a visitor's model. The latter is ideal in a meeting hall, providing elegant comfort for guests.

Dièsis è disponibile in tre versioni: alta con poggiatesta, bassa con base girevole e modello per visitatore. Quest'ultima è ideale in un sala meeting per avvolgere gli ospiti in un comfort elegante.



DIÈSIS executive chair | D02/326 fabric and Chrome frame
T45 meeting table | Elm top and legs
CARTESIO ceiling track with Globe lights | Black

DESIGN OFFICE





DIÈSIS executive chair | C05/280 fabric and Black frame
X7 meeting table | Matt White glass top and Matt White legs





The tall version of Dièsis is perfect for matching with an executive desk: its ergonomic and soft back and aluminium arms, which can be leather-covered, blend seamlessly with the structure.

La versione alta di Dièsis è perfetta da abbinare ad una scrivania direzionale: ha uno schienale ergonomico e morbido, unito a braccioli in alluminio, rivestibili in pelle, che si fondono nella struttura.





DIÉSIS executive chair | B03/177 simil leather and Chrome frame
X9 desk and meeting table | American Walnut top and Umbra Grey legs
HALF MOON pendant and floor lamp | Black fabric shade and Black base





Select materials, a responsible production process, attention to details: Dièsis embodies a universe of values in a simple and concise shape, with customisable colours and finishings.

Selezione dei materiali, processo di produzione responsabile, cura dei dettagli: Dièsis contiene un universo di valori in una forma semplice e sintetica, personalizzabile nei colori e nelle finiture.





DINAMICA

designed by Massimo Costaglia

**Dinamica and Dinamica
Soft combine ergonomic
design and comfort with
minimalist aesthetics,
in both the mesh and
upholstered versions.**

**Dinamica e Dinamica Soft coniugano ergonomia
e comodità con un'estetica minimale, sia nella
versione in rete che imbottita.**



DINAMICA executive chair | R05/153 mesh and Black frame
X5 meeting table | Elm top and Umbra Grey legs
ARTE sofa | P01/172 leather

Office & Meeting Chairs





DINAMICA SOFT executive chair | C05/290 fabric and White frame
UP&UP bench desk | White top and legs
FLY floor lamp | Matt White



The traditional shape of the executive seat is reinterpreted with a more distinctive style.

Quilting adds a dynamic touch to the seat, which is customisable thanks to an extensive selection of colours.

La forma tradizionale della sedia direzionale viene reinterpretata con uno stile più distintivo: la seduta è resa dinamica dalle trapuntature che la attraversano ed è personalizzabile grazie a un'ampia scelta di tonalità.



DINAMICA SOFT executive chair | B01/222 fabric and White frame
FLY pendant lamp | Matt White
X4 bench desk | White and Oak legs, Oak top with B01/222 fabric acoustic screen

Office & Meeting Chairs





Engineering and design seamlessly converge to create a seat that provides impeccable shape and support, durable in the face of frequent and prolonged use, thanks to a monocoque specially conceived to withstand such conditions.

Quando l'ingegneria incontra il design nasce una seduta curata nella forma e capace di sostenere le sollecitazioni di un uso frequente e prolungato, grazie a una monoscocca progettata per questa esigenza.



DINAMICA executive chair | R05/150 mesh and Black frame
X3 desk | Umbra Grey and Oak legs, Oak top and doors
EUSTRESS pendant lamp | Matt White

DESIGN OFFICE







DINAMICA SOFT executive chair | C05/279 fabric and Black frame
X6 desk and meeting table | Umbra Grey metal top and legs
TUBE pendant lamp | Black



DINAMICA executive chair | R05/150 mesh and White frame
X5 bench desk | White legs and top with B01/012 fabric acoustic screen
BLONDE pendant lamp | Matt White

The Dinamica Soft version captures the gaze, with visible stitching, masterfully and precisely finished to evoke a sense of artisan finesse and manual attention.

La versione Dinamica Soft cattura lo sguardo con le cuciture a vista, lavorate sapientemente e con precisione, che evocano un immaginario di dedizione artigiana e cura manuale.





DEKORA

designed by Quadrifoglio Group

**Classic canon.
Dekora sets the standard for
office chairs: well-defined
lines, adjustable positions
and ergonomic upholstery,
to suite all requirements.**

**Canone classico.
Dekora detta il paradigma della sedia da ufficio:
linee definite, postura regolabile e imbottiture
ergonomiche, per tutte le esigenze.**



DEKORA PLUS executive chair | C05/280 fabric
T45 desk | Canaletto Walnut top and legs
HALF MOON table lamp | Black fabric shade and Black base

Office & Meeting Chairs







DEKORA executive chair | R02/101 mesh
X7 meeting table | Eucalyptus top and Chrome legs
PLANET pendant lamp | Bronze
MELBOURNE pot | Umbra Grey



DESIGN OFFICE

Dekora is available in three versions: mesh, soft and plus, with a low or tall back and fitted with an original tubular insert that acts as a handle, useful for moving the chair.

Dekora è disponibile in tre versioni: rete, soft e plus, con schienale basso o alto, dotato di un originale inserto tubolare che funge da manico, utile per movimentare la sedia.







designed by Dorigo Design

**Feel good.
Diade is the best ally for
well-being at work, for
executive, semi-executive
and operative workstations,
thanks to its comfortable
seat and range of height
and depth adjustments.**

Stare bene.

**Diade è l'alleata migliore del benessere
lavorativo, sia per le postazioni direzionali che
semi-direzionali e per quelle operative, grazie
alla seduta confortevole e alle diverse regolazioni
disponibili, in altezza e in profondità.**







DIADE executive chair | B03/186 simil leather
X8 meeting table | Silk Grey lacquered top and Umbra Grey legs
PIPES pendant lamp | Bronze

Office & Meeting Chairs



Diade is available in a tall version, with or without a headrest, and a low version, adding elegance and personality to meeting rooms. It adapts to different interiors and settings, thanks to numerous customisation options.

Diade è disponibile nella versione alta, con o senza poggiatesta, e bassa, per arredare sale meeting con eleganza e personalità. Si adatta a diversi ambienti e atmosfere, grazie alle numerose possibilità di personalizzazione.



**The back is embellished
by visible stitching, which
adds a dynamic touch,
conveys a decisive style
and enhances details.**

Lo schienale è impreziosito da una serie di cuciture a vista che ne rendono dinamico l'aspetto, esprimono uno stile deciso e mettono l'accento sull'attenzione dei particolari.



DIADE executive chair | P01/096 leather
X8 desk | Eucalyptus top and Umbra Grey legs
CABINET | Umbra Grey lacquered doors, top and sides

DESIGN OFFICE





DIADE executive chair | B03/177 simil leather and B03/184 simil leather arm pads
X5 desk | Elm top and Umbra Grey legs
LIBRERIA bookshelves | Umbra Grey lacquer



DIADE executive chair | D02/272 fabric and B03/184 simil leather arm pads
X9 desk | American Walnut top and Matt White legs
BLONDE pendant lamp | Black



Slender armrests with soft edges sculpt a graceful and harmonious seat shape, for a well-balanced aesthetic result.

Braccioli affusolati dai perimetri morbidi donano alla seduta una struttura slanciata e armonica, contribuendo all'equilibrio complessivo dell'estetica.





designed by Dorigo Design

**Minimal solo.
Diade Rock is the
operative seat that adds
grit and well-being to
every working day, with
excellent ergonomics and
customisable aesthetics.**

**Assolo minimal.
Diade Rock è la seduta operativa che
dà grinta e benessere a ogni giornata
di lavoro, con un'ergonomia studiata e
un'estetica personalizzabile.**



DIADE ROCK task chair | C05/284 fabric and R09/360 mesh, White frame
X4 desk and bench desk | White and Oak legs, Oak top
BOISERIE | Pigeon Blue lacquered back and Matt White lacquered doors





Diade Rock is available in a tall version with or without headrest. The seat and lumbar support cover is available in different fabric and colour options, while the back, available in grey or black mesh, adds a rock vibe to the seat.

Diade Rock è disponibile in versione alta, con o senza poggiatesta. Il rivestimento del sedile e del poggiatesta è realizzabile in diverse tipologie di tessuti e colori, mentre lo schienale, disponibile in rete grigia o nera, conferisce alla seduta un riverbero rock.





DIADE ROCK task chair | C05/293 fabric and R09/360 mesh, White frame
X5 bench desk | White top and Umbra Grey legs



DIADE ROCK task chair | B01/014 fabric and R09/361 mesh, White frame
UP&UP bench desk | Elm top, White legs and B01/014 fabric screen
LIGHTSOUND system | B01/014 and B01/012 Cloak panels and Matt White Triangle lamps









DIADE ROCK task chair | C05/303 fabric and R09/360 mesh, Black backrest, Chrome base and arms
X3 bench desk | White top, Umbra Grey legs
BABEL pendant lamp | Black fabric shade

The seat is fitted with a lumbar support that can be adjusted to meet all comfort requirements. Leather or fabric upholstery covers are available, for a matching seat with an original style.

La seduta è dotata di un poggiatesta regolabile a seconda delle esigenze di comfort. L'imbottitura è rivestibile in pelle o tessuto, per intonarsi al sedile con uno stile ricercato.





designed by Activa

**Ode to design.
Ode is the operative
seat featuring minimal
lines and superior
functionality, for
a welcoming and
customised workstation.**

Ode al design.
Ode è la sedia operativa dalle linee minimal e
dall'elevata funzionalità, per una postazione
lavorativa accogliente e personalizzata.



ODE task chair | R10/622 mesh and White frame
UP&UP bench desk | Elm top and White legs
S1 storage wall | Umbra Grey lacquered doors and panels
CARTESIO ceiling track with Spotlights | Black



ODE task chair | R10/623 mesh and Black frame
X1 bench desk | White top and legs
PIPES pendant lamp | Matt White

Office & Meeting Chairs



Ode is fitted with a hi-tech synchro mechanism, discretely built into the monocoque, for seat height and position adjustment according to personal needs.

Ode è dotata di un meccanismo synchro altamente tecnologico, integrato discretamente nella monoscocca, per regolare l'altezza della sedia e offrire la possibilità di cambiare posizione in base alle necessità personali.









Every single detail contributes towards individual well-being, from armrests to adjustable lumbar support, so that you face each working day in the best possible way. Customisable colours add character to every office.

Ogni dettaglio contribuisce al benessere della persona: dai braccioli al poggiatesta regolabile, per affrontare al meglio le giornate di lavoro. I colori sono customizzabili, per dare carattere a ogni ufficio.





ODE task chair | R10/624 mesh and White frame
X3 bench desk | White and Oak legs, White top
BLONDE pendant lamp | Matt White



ODE task chair | R10/623 mesh and White frame
X4 bench desk | White legs and top
FLY pendant lamp | Matt White



Ode is also available in the tall version with headrest, providing fundamental back and cervical support during work. The aesthetic effect remains simple and essential, ideal for adapting to single or shared workstations.

Ode è disponibile anche nella versione alta con poggiatesta, un supporto fondamentale per la schiena e per la parte cervicale durante le ore di lavoro. L'estetica rimane semplice ed essenziale, ideale per adattarsi a postazioni singole e condivise.







OXYGEN

designed by S.I. Design

**A breath of fresh air.
Modern and functional,
Oxygen is the operative
seat that takes centre
stage in open spaces,
suitable for individual and
shared workstations.**

**Respiro nuovo.
Moderna e funzionale, Oxygen è la seduta
operativa protagonista degli open space, adatta
sia a postazioni individuali che condivise.**







OXYGEN task chair | C01/054 fabric and White frame
GOUT pendant lamp | Glossy White and Black glass shade
TOURN ME! wall lamp | Matt White
X1 desk | White top and legs

Office & Meeting Chairs



Oxygen is available in mesh or upholstered finishing and can be covered with fabrics of different colours. The back guarantees long-lasting comfort, for optimal vertebral column support.

Oxygen è disponibile con finitura in rete o con imbottitura ed è rivestibile con tessuti di diverso colore. Lo schienale garantisce un comfort durevole, grazie al sostegno ottimale della colonna vertebrale.

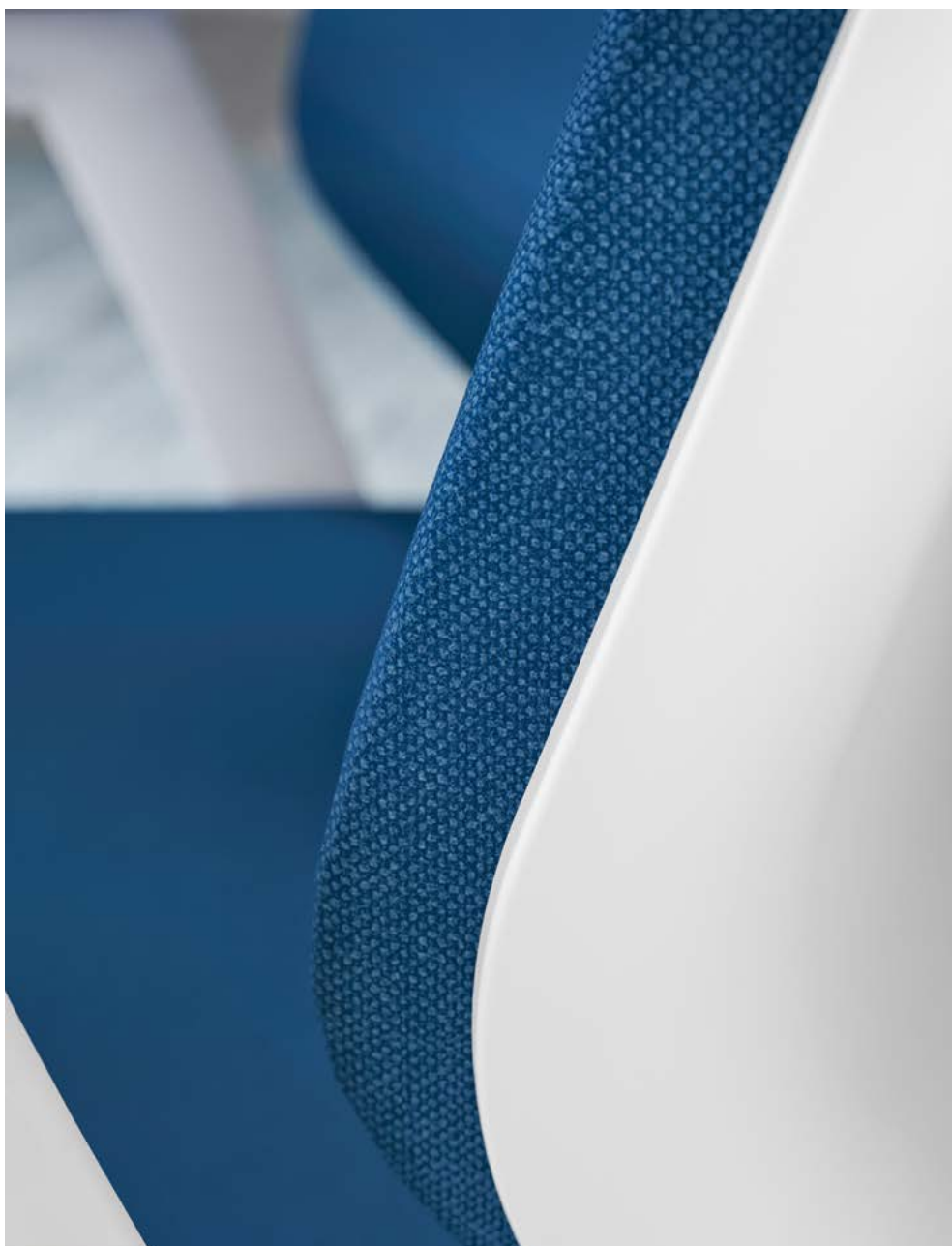

**Clean-cut aesthetics, for comfort tailored to the individual.
Oxygen is fitted with a seamlessly integrated side shift mechanism for seat adjustment.**

Un'estetica pulita, per una comodità a misura della singola persona: Oxygen è dotata di un traslatore per la regolazione della seduta, perfettamente integrato nel sedile.









OXYGEN task chair | R06/230 mesh and B01/020 fabric, White frame
X4 bench desk | White legs, Elm top and B01/020 fabric acoustic screen
LIBRERIA bookshelves | White
MORE floor lamp | Matt White



In addition to providing back support, Oxygen is also fitted with a lumbar support, further enhancing comfort and enabling the user to maintain a correct posture.

Oltre al sostegno della schiena, Oxygen è dotata di un poggiatesta, per far accomodare piacevolmente chi si siede e aiutare la persona a mantenere una corretta postura.





OMNIA

designed by Quadrifoglio Group

**Innovative tradition.
Omnia is the perfect seat
for operative workstations:
a spacious seat, a spacious
back and a structure
designed to guarantee
comfort.**

Tradizione innovativa.

Omnia è la sedia perfetta per i luoghi di lavoro operativi: seduta ampia, schienale largo e una struttura progettata per assicurare la comodità.





OMNIA task chair | R06/229 mesh and C05/295 fabric
IDEA+ TUBE bench desk | White top and legs
LOCKERS | White carcass and Oak doors
CARTESIO pendant track with Master and Queen lights | Black

DESIGN OFFICE



The seat is available in mesh and upholstered versions, customisable thanks to an extensive selection of fabrics in different tonalities, adding a touch of colour and a coordinated image to office spaces.

La seduta è disponibile in versione rete e imbottita, personalizzabile grazie a una vasta scelta di tessuti in diverse tonalità, per dare colore e coerenza di stile all'ufficio.





OMNIA task chair | R06/229 mesh and C05/285 fabric
X3 desk | Oak top and Umbra Grey legs
CARTESIO pendant track with Queen and Globe lights | Black

Office & Meeting Chairs



Industrial settings, modern office spaces and classic offices: the total black mesh version of Omnia is indicated for creating an authoritative and professional ambience in different places.

Ambienti industrial, open space moderni e uffici classici: la versione in rete total black di Omnia è indicata per creare atmosfere autorevoli e professionali in luoghi diversi.





designed by Quadrifoglio Group

**One name, one destiny.
Okay is a practical and
flexible operative seat with
adjustable height, back
inclination and depth-
adjustable armrests.**

**Un nome, un destino.
Okay è una seduta operativa pratica e flessibile:
è regolabile in altezza, nell'inclinazione dello
schienale e nella traslazione dei braccioli.**



OKAY task chair | B03/177 simil leather and White frame
IDEA+ PANNELLO desk | White top and legs
MORE floor lamp | Matt White
MIAMI metal pot | Matt White

Office & Meeting Chairs







OKAY task chair | R07/251 mesh and C05/291 fabric, Black frame
X3 bench | White top and Umbra Grey legs
P1 partition wall | Matt White tracks and Elm panels



In addition to excellent lumbar support, Okay also supports the vertebral column with an adjustable lumbar support.

All parts are customisable with different colours: aesthetic appeal and functionality go hand in hand.

Oltre a offrire un eccellente supporto lombare, Okay sostiene la colonna vertebrale con un poggiatesta regolabile. Tutte le componenti sono personalizzabili nei colori: estetica e funzionalità vanno di pari passo.



OKAY task chair | B01/014 fabric and Black frame
X4 desk | White and Oak legs, White top
P1 boiserie | Oak panels and White floating elements



DESIGN OFFICE



140

OKAY task chair | R07/250 mesh and B01/023 fabric, White frame
X1 desk | White legs and Oak top
HALF MOON floor lamp | Black fabric shade and Black base

Thanks to the spacious and enveloping mesh or upholstered back, and armrests that are adjustable according to needs, Okay guarantees tailored comfort, making it the best ally for long work days.

Grazie allo schienale ampio e accogliente, in rete o imbottito, e ai braccioli regolabili a seconda delle esigenze, Okay garantisce un comfort su misura ed è la migliore alleata nelle lunghe giornate di lavoro.





Meeting Chairs Index

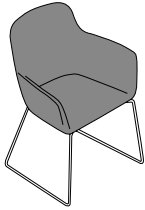

CITY

144 | 151



COVE

152 | 159

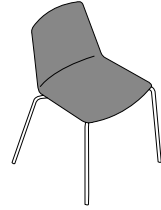

CLUE

160 | 167



CLOUD

168 | 177



CLOSE

178 | 185



C-STOOL

186 | 191



designed by Edi & Paolo Ciani

**Metropolitan attitude.
City is a collection of seats
with slender profiles,
soft and comfortable
upholstery, available with
different bases suitable for
different settings.**

**Attitudine metropolitana.
City è una collezione di sedute dai profili sottili, dalle imbottiture
morbide e confortevoli e con diversi basamenti disponibili, per
adattarsi all'ambiente prescelto.**











A sartorial concept and industrial finish. City is inspired by technical and aesthetic research. Different upholstery thicknesses guarantee superlative comfort and double stitching provides optimal fabric tautness.

Un concept sartoriale e una lavorazione industriale: City è frutto di una ricerca tecnica ed estetica. Le diverse densità dell'imbottitura garantiscono comfort assoluto e la doppia battitura delle cuciture assicura una tensione ottimale del tessuto.





CITY design chair | C05/290, C05/289 and C05/282 fabric, Umbra Grey frame
X6 table | Invisible White porcelain stoneware top and Umbra Grey legs
PLANET pendant lamp | Gold



designed by Dorigo Design

**Transversal appeal.
Cove is a line of seats for
the office with numerous
customisation options,
from bases to finishings
and body materials.**

**Charme trasversale.
Cove è una linea di sedute per l'ufficio che offre
numerose personalizzazioni, dai basamenti alle
finiture, fino ai materiali delle scocche.**





COVE design chair | White polypropylene shell and C05/295 fabric and Silver frame
COVE design chair | C05/295 fabric and Silver frame
X4 desk and meeting table | Whitened Elm top and White legs







COVE bench | Ocher polypropylene shell and B01/009 fabric upholstered seat, Silver frame
GOUT pendant lamp | Glossy/White glass shade
T05 coffee table | White



The polypropylene shell can be covered with a selection of leathers, fabrics, simil leathers and wool. Also available in a bench version, Cove is ideal for operative workstations, shared spaces for relaxation, waiting areas and meeting rooms.

La scocca in polipropilene può essere rivestita scegliendo tra pelle, tessuto, similpelle e lana. Componibile anche nella versione panca, Cove è ideale per postazioni operative, spazi relax condivisi, aree d'attesa e sale riunioni.





CLUE

designed by Dorigo Design

**Versatile simplicity.
Clue is a collection of
seats characterised by
a linear and geometric
design, in which comfort
and classic taste converge,
for a product suitable in a
number of settings.**

Semplicità versatile.

**Clue è una collezione di sedute dal design lineare
e geometrico: un connubio di comfort e classicità,
adatto per molteplici destinazioni d'uso.**













Available in numerous versions, including the bench one, stackable and accompanied by accessories like a side table or flat rest surface, Clue generates a distinctive note for reserved and common areas.

Disponibile in numerose varianti, tra cui la versione panca, il modello impilabile, quello accessorato con tavolino o con piano d'appoggio, Clue arreda con decisione spazi riservati e comuni.





CLUE bench | C05/295 fabric upholstered shell and Olive Green polypropylene shell, Umbra Grey frame
CARTESIO ceiling track with Queen lights | Black

CLOUD

designed by S.I. Design

**Universal formality.
Cloud is so much more
than a cantilever, it truly
is a complete collection
of seats featuring a
classic yet timeless style.**

**Formalità universale.
Cloud è molto più di una cantilever, una vera e
propria collezione completa di sedute dallo stile
classico ma sempre attuale.**







With Cloud it is possible to experiment with dynamic pairings, thanks to a selection of different armrests, bases and backs, available in mesh or upholstered, adapting to operative and meeting areas alike.

Cloud permette di sperimentare accostamenti dinamici tra i braccioli, i basamenti e lo schienale, disponibile in rete o con imbottitura, per adattarsi a spazi operativi e ad aree meeting.





CLOUD chair | C05/279 fabric and R02/101 mesh, Chrome frame
SERENITY meeting table | Whitened Elm-top and Umbra Grey frame
CARTESIO pendant track with Queen lights | Black







Cloud is synonymous with versatility: each part can be customised, making the seat suitable for waiting rooms, offices, collective spaces and reception areas.

Cloud e versatilità sono sinonimi: grazie alla possibilità di personalizzare ogni componente, la seduta è adatta per sale d'attesa, uffici, spazi collettivi e luoghi dedicati all'accoglienza.





CLOSE

designed by Scagnellato & Ferrarese

**Multi-functional design.
Close is a geometric and
inviting seat, making it
ideal for conference halls,
canteens, coffee break
areas and training rooms.**

**Design polivalente.
Close è una seduta geometrica e accogliente:
ideale per sale conferenze, mense, zone di
coffee break e sale per la formazione.**





180

CLOSE high stool | Grey shell with D02/274 fabric, Chrome frame
COZY coffee table | Umbra Grey top and legs







Close is available in stool version; it is also customisable, with a selection of different materials and covers.

The back, featuring a striped pattern, adds a touch of personality to the seat, guaranteeing postural comfort.

Close è disponibile nella versione alta e sgabello ed è customizzabile scegliendo tra diversi materiali e rivestimenti. Lo schienale lavorato con un motivo a righe aggiunge personalità alla seduta e garantisce comfort posturale.



CLOSE high stool | White and Red shell with C05/290 fabric, Chrome frame
CD LED pendant lamp | Black



DESIGN OFFICE



C-STOOL

designed by Atelier Studio Borella

**Dynamic interaction.
Available in the tall or low
version, with customisable
colours and finishings,
C-stool educates the body
to actively search for a
correct posture.**

Relazione dinamica.

**Disponibile nella versione alta o bassa, con colori
e finiture personalizzabili, C-stool educa il corpo a
ricercare attivamente una postura corretta.**





C-STOOL high stool | D02/326 fabric and White frame
CREO high table | Oak top and White legs



The subtle inclination of C-Stool, combined with the lack of back or armrests, guarantees participatory ergonomics, enabling the user to work in a different, more mindful and productive way.

La leggera inclinazione di C-Stool, unita all'assenza di schienale e braccioli, assicura un'ergonomia partecipata, offrendo alle persone un nuovo modo di vivere il lavoro, con un atteggiamento più consapevole e produttivo.



C-STOOL low stool | C05/284 fabric and White frame
ADD pendant lamp | Matt Clay and Glossy White
X1 table | White top and legs

DESIGN OFFICE





1.

2.

3.

4.

5.

6.

6

WARM COLOURS MOODBOARD

Bronze, walnut and black tonalities dance among smooth and matt surfaces, in a duo of linear and marble veining. Perfect paired with elegant and sophisticated interiors, where originality and attention to detail are key elements.

Toni di bronzo, noce e nero danzano tra superfici lisce e opache, in un duetto di venature lignee e marmoree. Abbinamenti ideali per ambienti di grande eleganza e classe, dove ricercatezza e la cura del dettaglio sono elementi irrinunciabili.

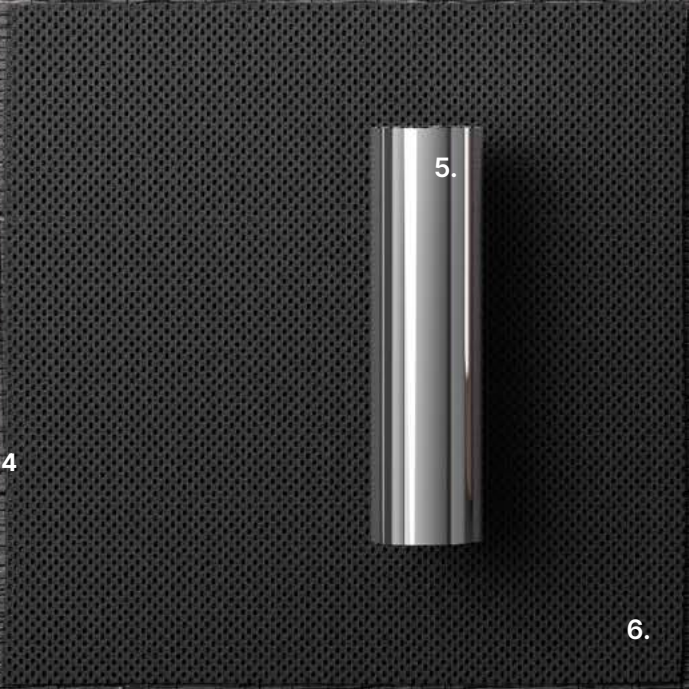
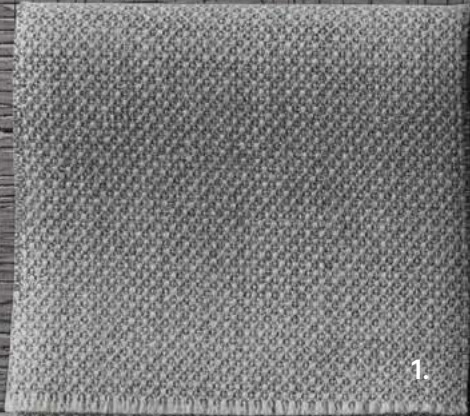

COOL COLOURS MOODBOARD

**Fabrics, eucalyptus woods,
lacquered tops and perforated
nets create infinite shades of
grey, in a condition of spiritual
comfort, for modern and
refined operative spaces.**

Tessuti, legni di eucalipto, piani laccati e reti traforate
creano infinite sfumature di grigio, in una condizione di
agiatezza spirituale, per spazi operativi moderni e curati.



NATURAL COLOURS MOODBOARD

The purity of light is expressed in a triumph of whites and tenuous colours, amid porcelain stoneware, fabric and wood, for areas inspired by the colours of nature, inspiring a mood of well-being and peacefulness.

La purezza della luce si declina in un tripudio di bianchi e colori tenui, tra gres porcellanato, tessuto e legno per spazi ispirati ai colori della natura, che invitano ad uno stato d'animo di benessere e serenità.



ELEGANCE COLOURS MOODBOARD

The austere elegance of umbra grey and black pervades fabrics, leathers and stoneware tops, stripping style down to the essential. Ideal pairings for executive offices, meeting rooms or reception areas.

L'eleganza austera del grigio ombra e del nero pervade tessuti, pelli e piani in gres, riconducendo lo stile all'essenziale. Accostamenti ideali per uffici direzionali, sale riunioni di rappresentanza o aree di accoglienza.

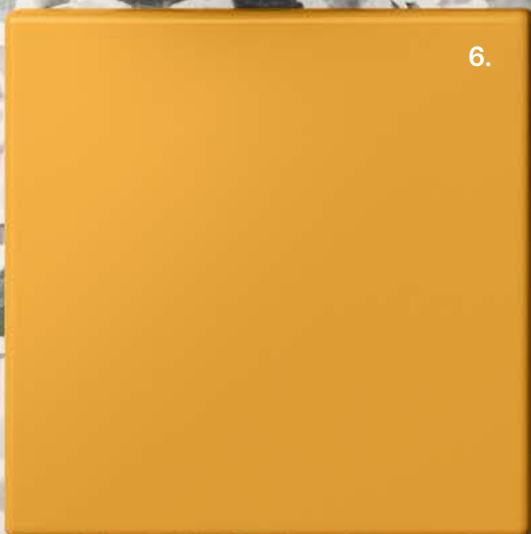
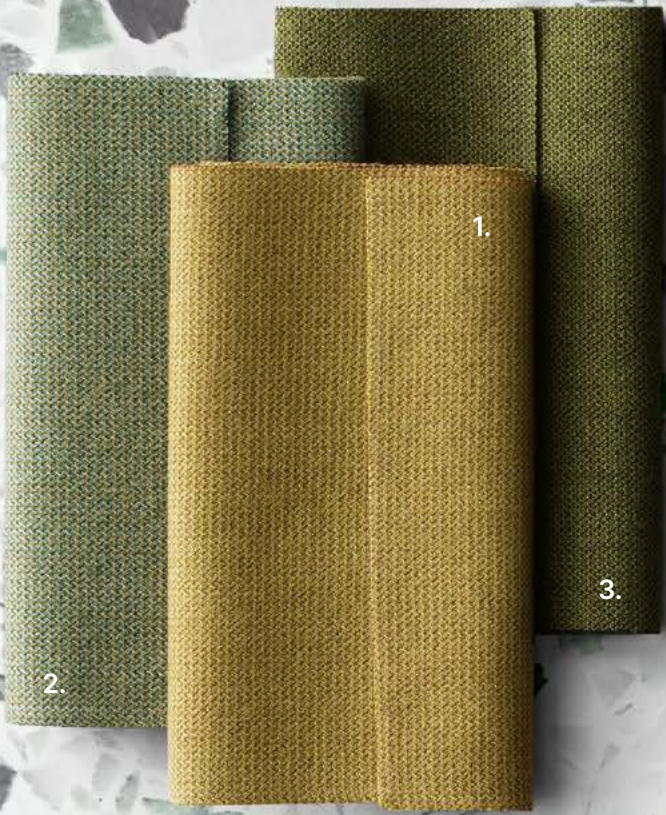

ECLECTIC COLOURS MOODBOARD

The vitality of fabrics, wood and metal is expressed in a palette rich in earth colours, including shades of green, yellow and brown, for creative, fresh and contemporary interiors.

La vitalità di tessuti, legni e metalli si esprime in una palette ricca dei colori della terra, tra sfumature verdi, gialle e marroni per ambienti creativi, freschi e contemporanei.

Shapes and sizes

Abaco degli elementi

Office & Meeting Chairs

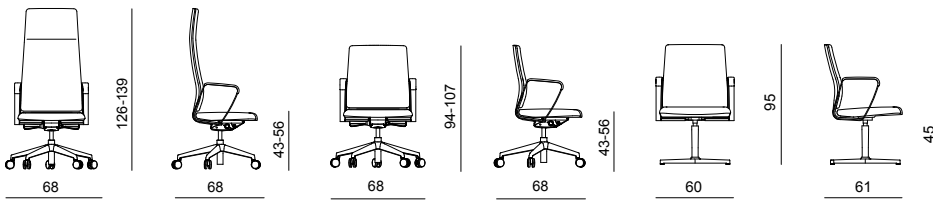

BASE FINISH OPTIONS
FINITURE DISPONIBILI BASE

METAL
METALLO



SHELL FINISH OPTIONS
FINITURE DISPONIBILI SCOCCA

FABRICS AND LEATHERS
TESSUTI E PELLI



B01-B03-C01-C05-D02-D03-
D04-D05-D06-E01-E02-P01

BACK FINISH OPTIONS
FINITURE DISPONIBILI SCHIENALE

WOOD VENEER
LEGNO IMPIALLACCIATO

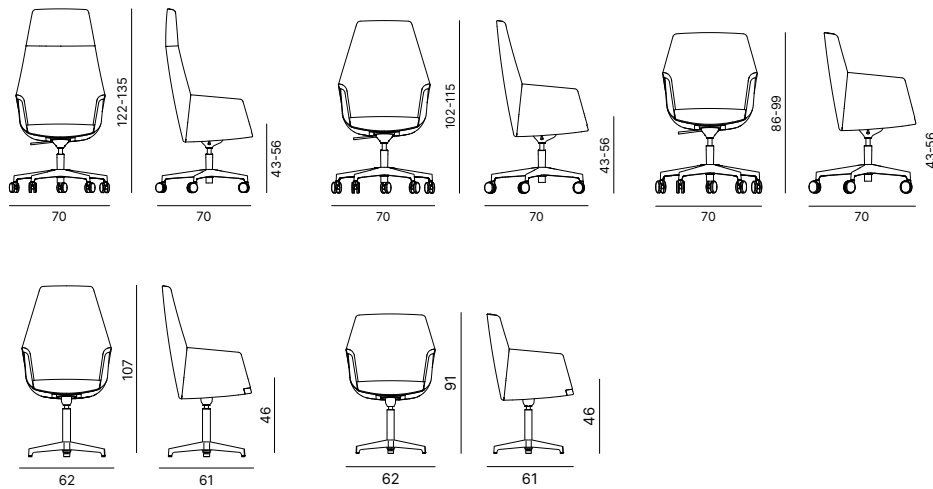

BASE FINISH OPTIONS
FINITURE DISPONIBILI BASE

METAL
METALLO



SHELL FINISH OPTIONS
FINITURE DISPONIBILI SCOCCA

FABRICS AND LEATHERS
TESSUTI E PELLI



B01-B03-C01-C05-D02-D03-
D04-D05-D06-E01-E02-P01

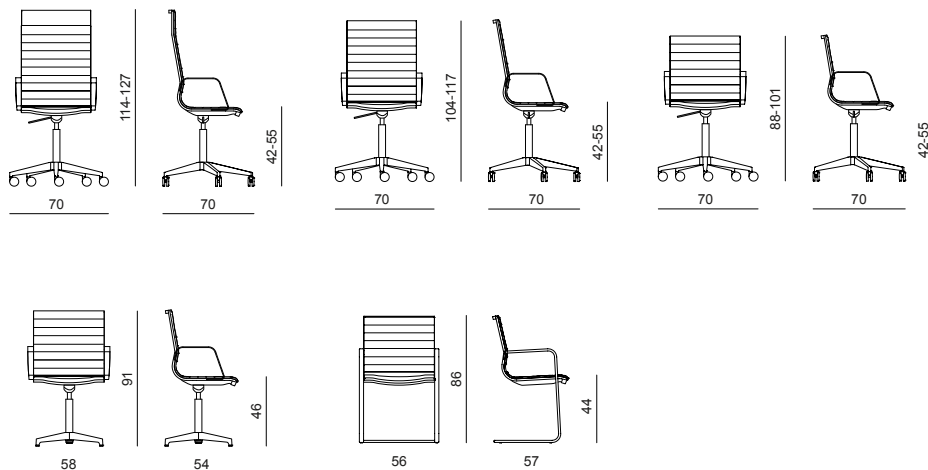

BASE FINISH OPTIONS
FINITURE DISPONIBILI BASE

METAL
METALLO



SHELL FINISH OPTIONS
FINITURE DISPONIBILI SCOCCA

FABRICS AND LEATHERS
TESSUTI E PELLI



B01-B03-C01-C05-D02-D03-
D04-D05-D06-E01-E02-P01

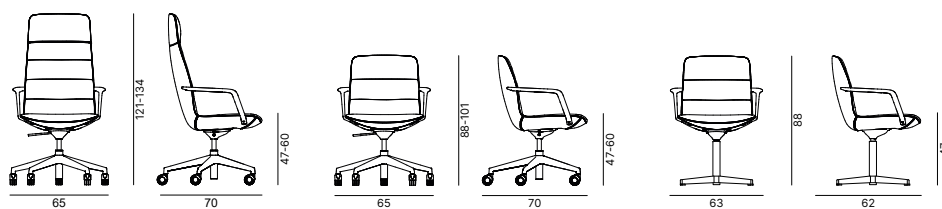

FRAME FINISH OPTIONS
FINITURE DISPONIBILI STRUTTURA

METAL
METALLO



SHELL FINISH OPTIONS
FINITURE DISPONIBILI SCOCCA

FABRICS AND LEATHERS
TESSUTI E PELLI



B01-B03-C01-C05-D02-D03-
D04-D05-D06-E01-E02-P01

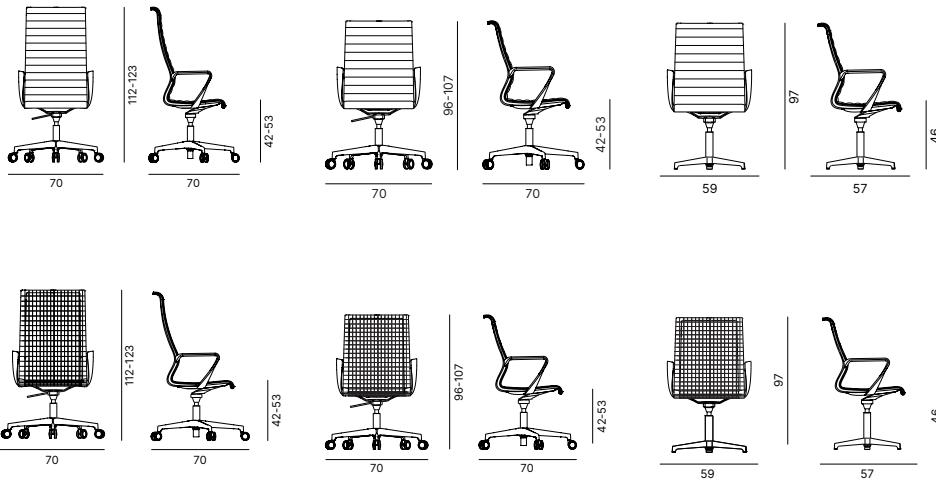

FRAME FINISH OPTIONS
FINITURE DISPONIBILI STRUTTURA

NYLON
NYLON



BASE FINISH OPTIONS
FINITURE DISPONIBILI BASE

NYLON
NYLON



METAL
METALLO



SHELL FINISH OPTIONS
FINITURE DISPONIBILI SCOCCA

FABRICS AND MESH
TESSUTI E RETI



B01-C05-R05

Office & Meeting Chairs

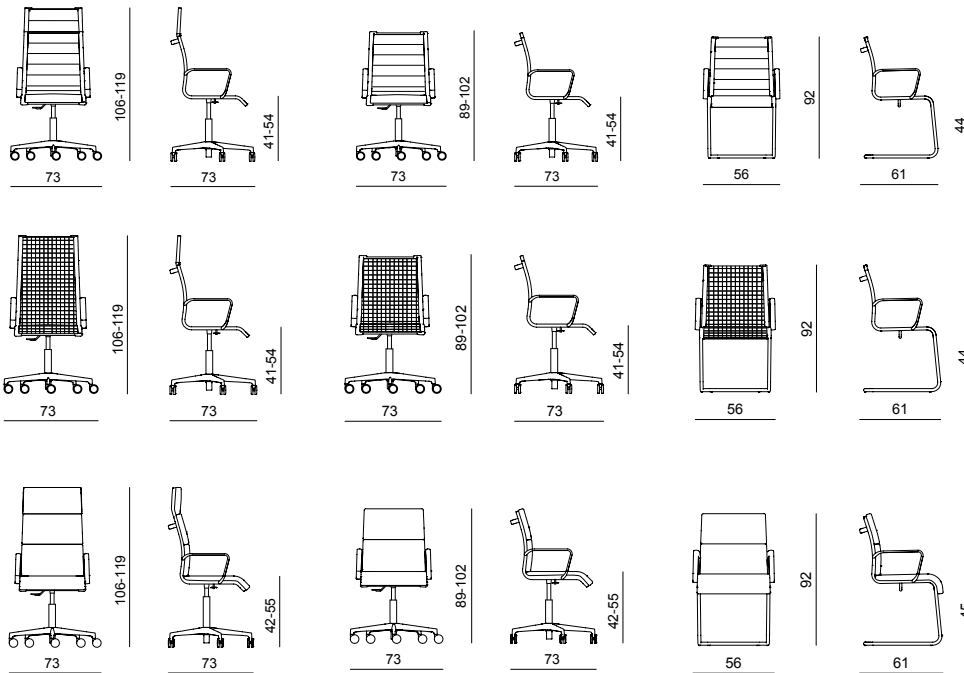

BASE FINISH OPTIONS
FINITURE DISPONIBILI BASE

METAL
METALLO



SHELL FINISH OPTIONS
FINITURE DISPONIBILI SCOCCA

FABRICS AND LEATHERS
TESSUTI E PELLI



B01-B03-C01-C05-D02-D03-D04-D05-D06-E01-E02-P01-R02

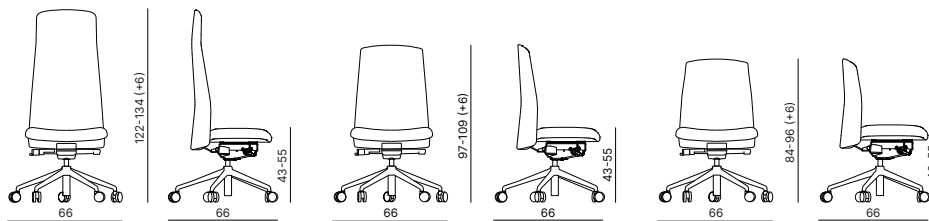

BASE FINISH OPTIONS
FINITURE DISPONIBILI BASE

METAL
METALLO



NYLON
NYLON



SHELL FINISH OPTIONS
FINITURE DISPONIBILI SCOCCA

FABRICS AND LEATHERS
TESSUTI E PELLI



B01-B03-C01-C05-D02-D03-D04-D05-D06-E01-E02-P01

Office & Meeting Chairs

DIADE ROCK

DESIGN OFFICE

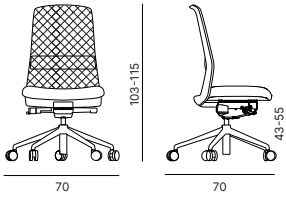

FRAME FINISH OPTIONS
FINITURE DISPONIBILI STRUTTURA

NYLON
NYLON



BASE FINISH OPTIONS
FINITURE DISPONIBILI BASE

NYLON
NYLON



METAL
METALLO



SHELL FINISH OPTIONS
FINITURE DISPONIBILI SCOCCA

FABRICS AND MESH
TESSUTI E RETI



B01-B03-C01-C05-D02-D04-D05-D06-E01-E02-P01-R09

Office & Meeting Chairs

ODE

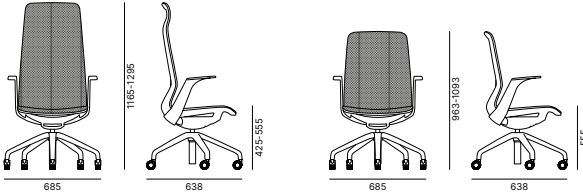

FRAME FINISH OPTIONS
FINITURE DISPONIBILI STRUTTURA

NYLON
NYLON



BASE FINISH OPTIONS
FINITURE DISPONIBILI BASE

NYLON
NYLON



METAL
METALLO



SHELL FINISH OPTIONS
FINITURE DISPONIBILI SCOCCA

MESH
RETE



R10

Office & Meeting Chairs

OXYGEN

Office & Meeting Chairs

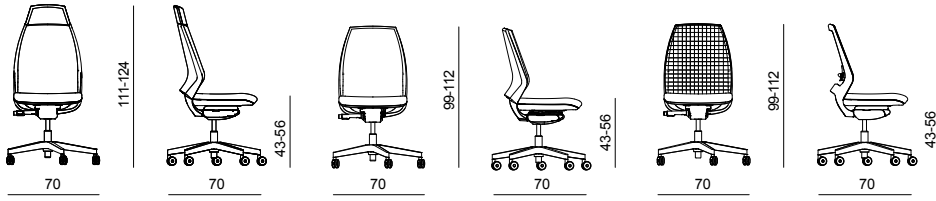

FRAME FINISH OPTIONS
FINITURE DISPONIBILI STRUTTURA

NYLON
NYLON



BASE FINISH OPTIONS
FINITURE DISPONIBILI BASE

NYLON
NYLON



METAL
METALLO



SHELL FINISH OPTIONS
FINITURE DISPONIBILI SCOCCA

MESH
RETE



B01-B03-C01-C05-D02-D03-D04-D05-D06-E01-E02-P01-R06

Office & Meeting Chairs

OMNIA

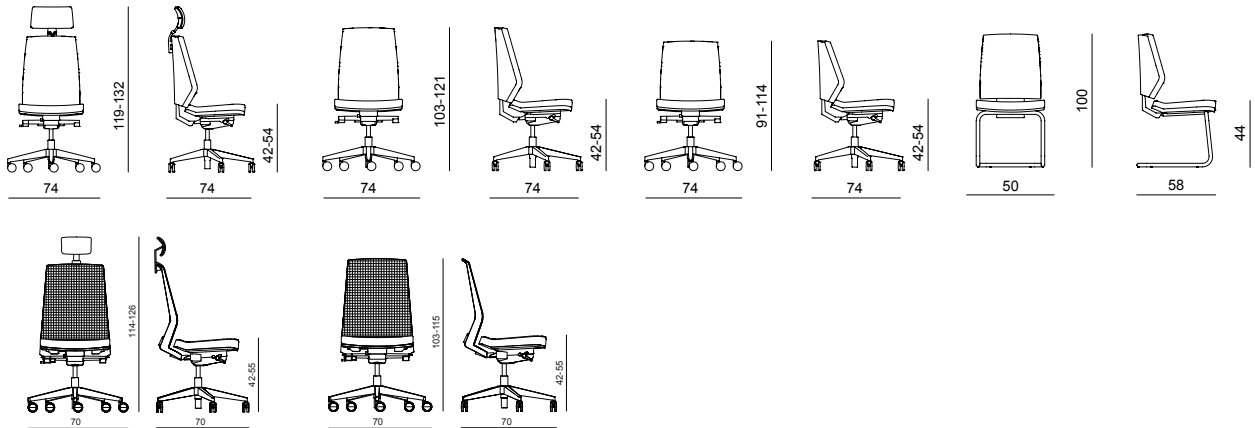

BASE FINISH OPTIONS
FINITURE DISPONIBILI BASE

NYLON
NYLON



METAL
METALLO



SHELL FINISH OPTIONS
FINITURE DISPONIBILI SCOCCA

FABRICS AND LEATHERS
TESSUTI E PELLI



B01-B03-C01-C05-D02-D03-D04-D05-D06-E01-E02-P01-R06

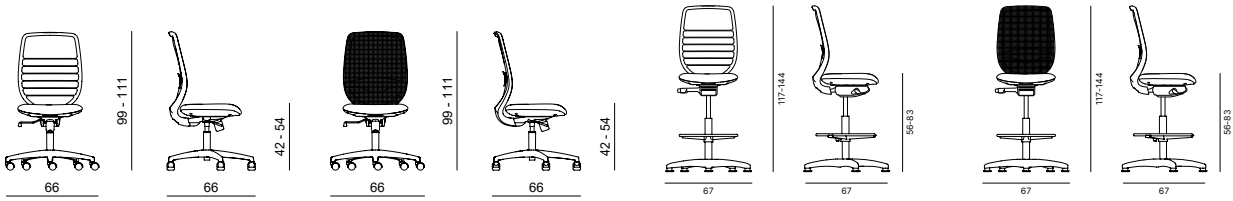

FRAME FINISH OPTIONS
FINITURE DISPONIBILI STRUTTURA

NYLON
NYLON



BASE FINISH OPTIONS
FINITURE DISPONIBILI BASE

NYLON
NYLON



METAL
METALLO



SHELL FINISH OPTIONS
FINITURE DISPONIBILI SCOCCA

WITH UPHOLSTERED BACK
CON SCHIENALE IMBOTTITO



B01-B03

WITH MESH BACK
CON SCHIENALE RETE



B01-B03-C01-C05-D02-D05-D06-E01-R07

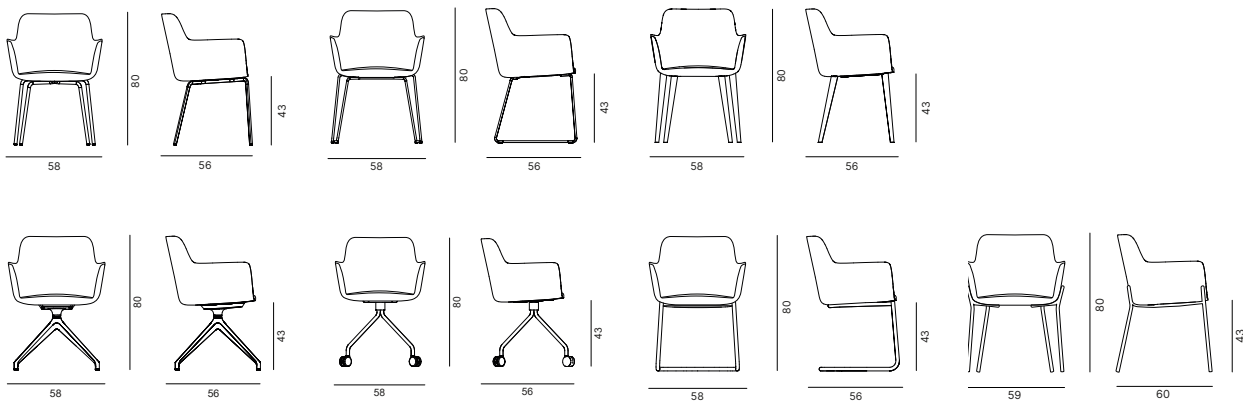

BASE FINISH OPTIONS
FINITURE DISPONIBILI BASE

METAL
METALLO



SHELL FINISH OPTIONS
FINITURE DISPONIBILI SCOCCA

FABRICS AND LEATHERS
TESSUTI E PELLI



B01-B03-C01-C05-D02-D03-D04-D05-D06-P01-E01-E02-E03-E04-I01-I02-M01-M02-M03

SOLID ASH WOOD
FRASSINO MASSELLO



Office & Meeting Chairs



BASE FINISH OPTIONS
FINITURE DISPONIBILI BASE

METAL
METALLO



SOLID ASH WOOD
FRASSINO MASSELLO



SHELL FINISH OPTIONS
FINITURE DISPONIBILI SCOCCA

POLYMERS
PLASTICA

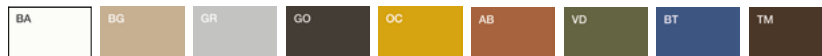

FABRICS AND LEATHERS
TESSUTI E PELLI

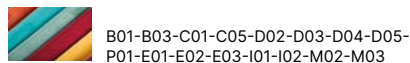

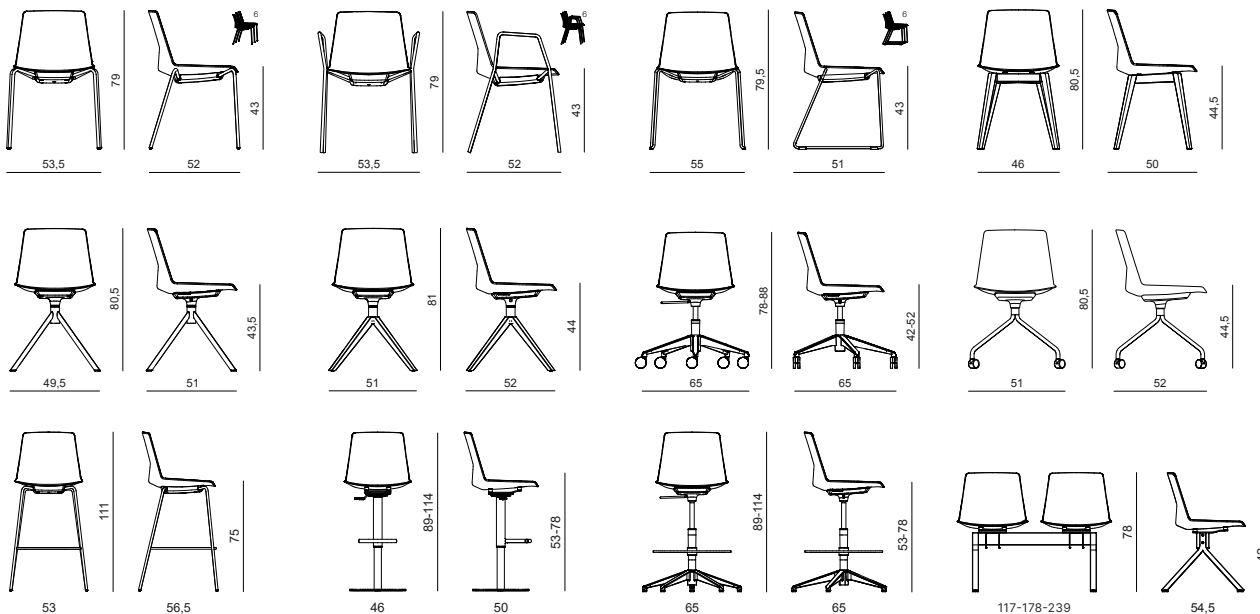

BASE FINISH OPTIONS
FINITURE DISPONIBILI BASE

METAL
METALLO



SOLID ASH WOOD
FRASSINO MASSELLO



SHELL FINISH OPTIONS
FINITURE DISPONIBILI SCOCCA

POLYMERS
PLASTICA



FABRICS AND LEATHERS
TESSUTI E PELLI



B01-B03-C01-C05-D02-D03-D04-D05-D06-
P01-E01-E02-E03-E04-I01-I02-M02-M03

Office & Meeting Chairs

CLOUD

Office & Meeting Chairs

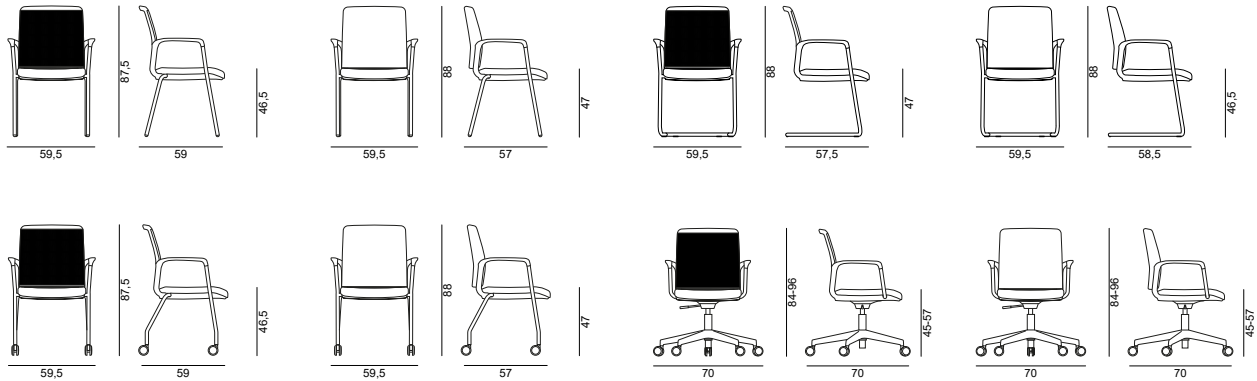

BASE FINISH OPTIONS FINITURE DISPONIBILI BASE

METAL METALLO



SHELL FINISH OPTIONS FINITURE DISPONIBILI SCOCCA

FABRICS AND LEATHERS TESSUTI E PELLI



B01-B03-C01-C05-D02-D03-D04-D05-D06-
P01-E01-E02-E03-R02

Office & Meeting Chairs

CLOSE

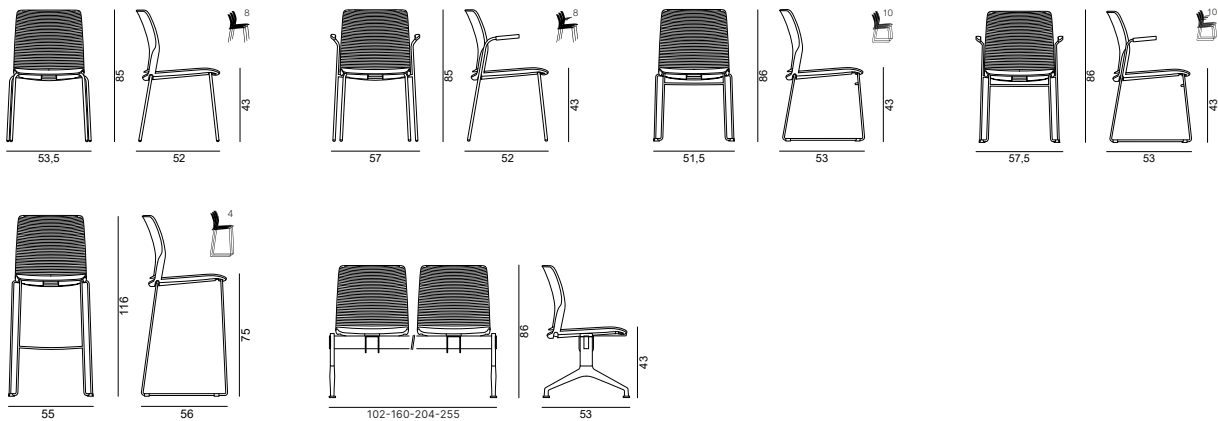

212

BASE FINISH OPTIONS FINITURE DISPONIBILI BASE

METAL METALLO

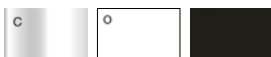

SHELL FINISH OPTIONS FINITURE DISPONIBILI SCOCCA

POLYMERS PLASTICA



SEAT FINISH OPTIONS FINITURE DISPONIBILI SEDILE

FABRICS AND LEATHERS TESSUTI E PELLI



B01-B03-C01-C05-
D02-D05-D06-E01

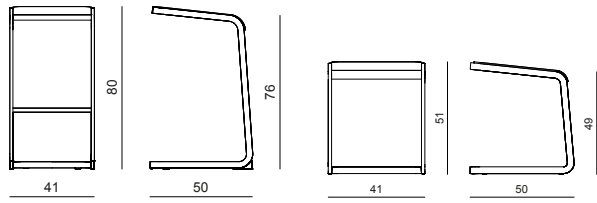

BASE FINISH OPTIONS
FINITURE DISPONIBILI BASE

METAL
METALLO



SEAT FINISH OPTIONS
FINITURE DISPONIBILI SEDILE

FABRICS AND LEATHERS
TESSUTI E PELLI



B01-B03-C01-C05-D02-D03-D04-D05-D06-
P01-E01-E02-E03-E04-I01-I02

Finishes and materials

Materiali e finiture

Office & Meeting Chairs

B01

On stock



DESIGN OFFICE

B03

On stock



C01

On stock



C05

On stock

Office & Meeting Chairs



D02

On stock



D03

On stock



D04



DESIGN OFFICE

D05

On stock



D06

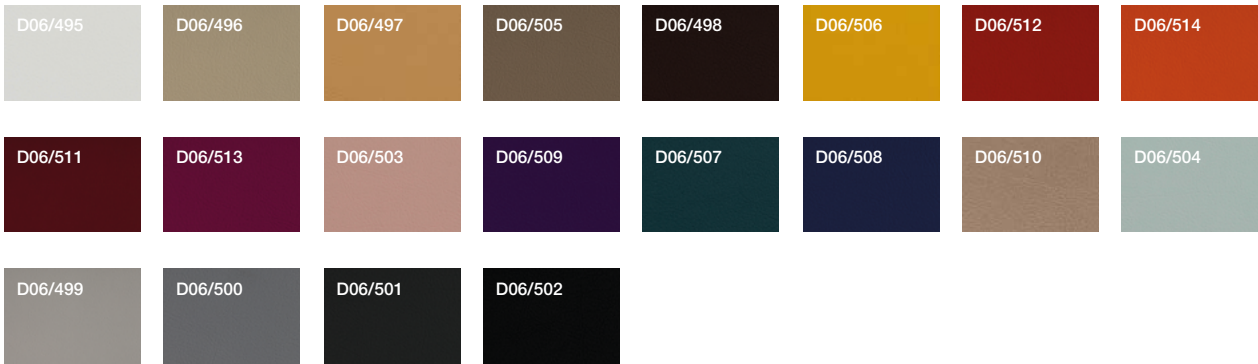

P01

On stock



Office & Meeting Chairs

E01

On stock



E02



E03



E04

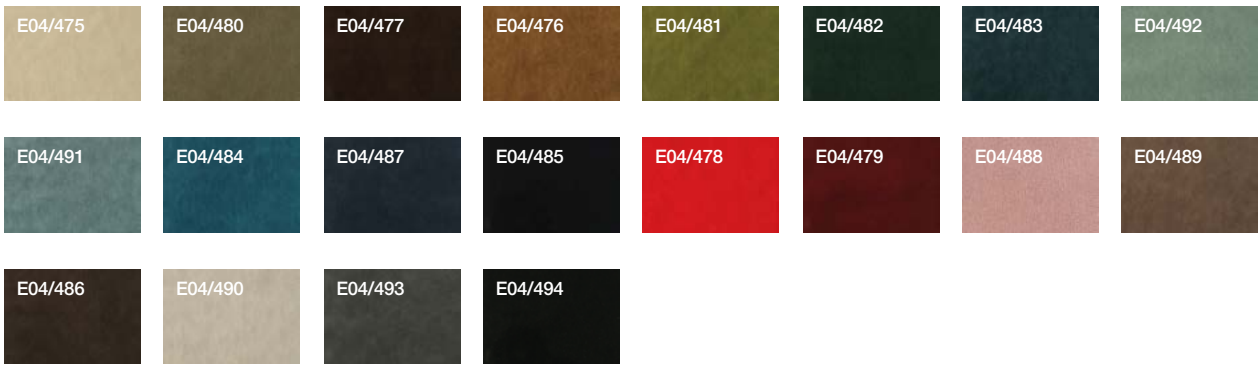

I01



I02

Office & Meeting Chairs



M01



M02

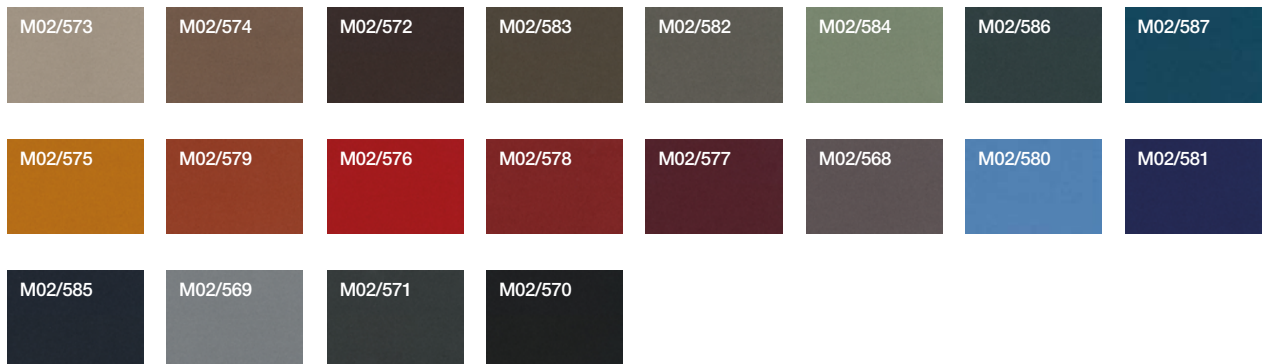

M03



DESIGN OFFICE

R02 On stock



R05 On stock

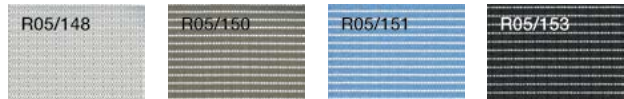

R06 On stock

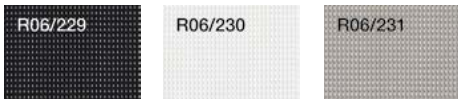

R07 On stock



R09 On stock



R10 On stock



Polymers



Metal



Wood veneer

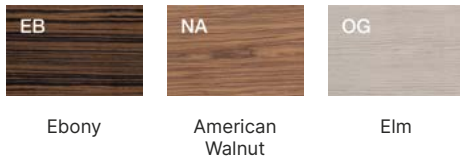

Solid ash wood

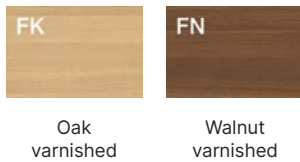



Product Design
Quadrifoglio Group R&D Dept.

Project Direction & Coordination
Quadrifoglio Group Marketing & Communication Dept.

Creative Direction
Willy Dalto

Graphic Design
Federica Mattietto

Images
Virtual Design, Trento

Color Separation & Print
Sincromia, Pordenone
June 2022

Cod. LI0COM22

Discover our Designers and Partners



